

Data sheet

Hydraulic data

Maximum operating pressure P_N	16 bar
Min. fluid temperature T_{\min}	-20 °C
Max. fluid temperature T_{\max}	140 °C
Min. ambient temperature T_{\min}	-15 °C
Max. ambient temperature T_{\max}	40 °C

Motor data

Mains connection	3~400 V, 50 Hz
Voltage tolerance	±10 %
Rated power P_2	0.37 kW
Motor efficiency class	IE3
Rated current I_N	0.99 A
Rated speed n	1385 1/min
Power factor $\cos \varphi_{100}$	0.62
Insulation class	F
Protection class motor	IP55

Installation dimensions

Pipe connection on the suction side DN_s	DN 50
Pipe connection on the discharge side DN_d	DN 32

Materials

Pump housing	5.1301/EN-GJL-250 KTL-coated
Impeller	Grey cast iron
Shaft	Stainless steel
Mechanical seal	AQ1EGG
Lantern	Grey cast iron

Pump curves

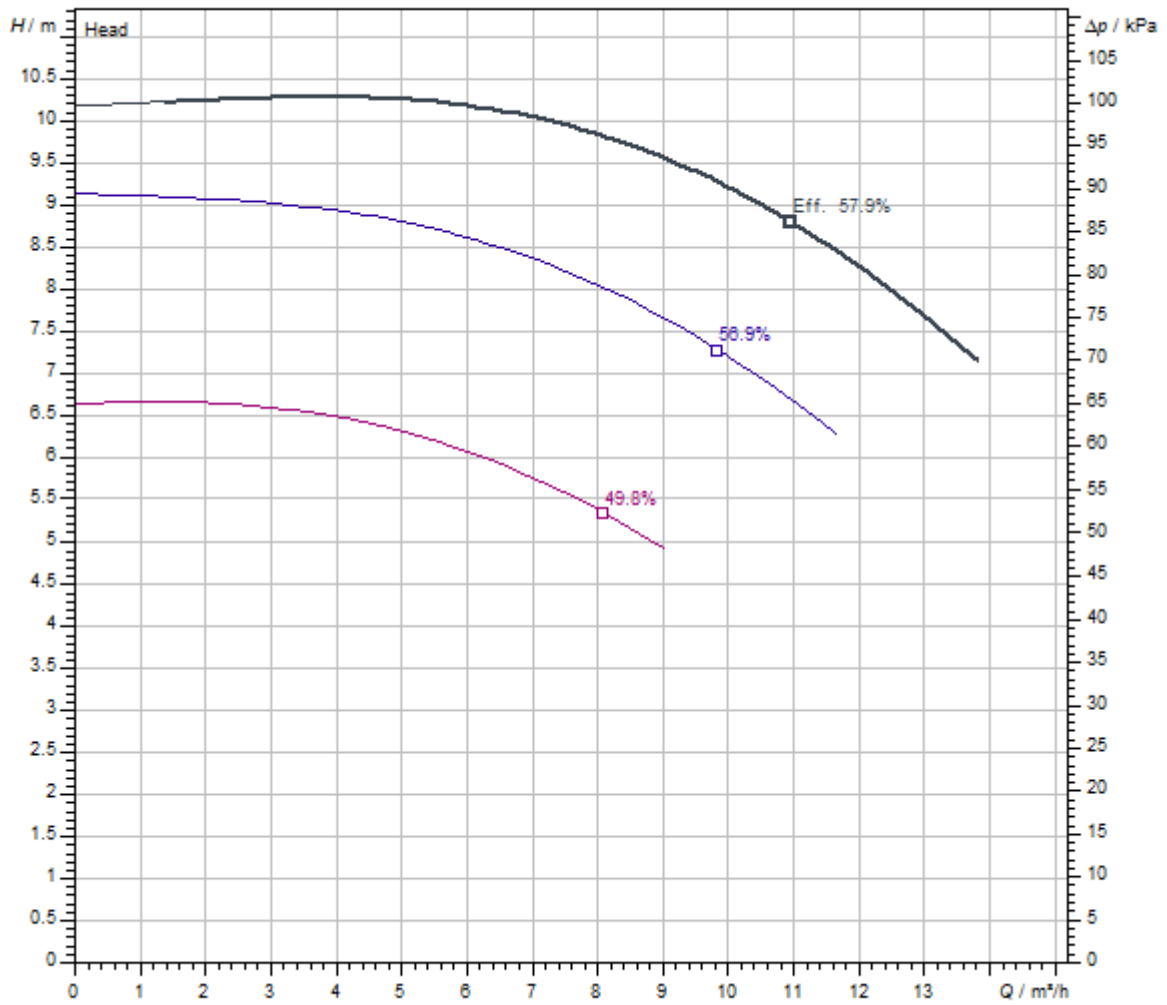

Standard	ISO 9906 3B
Fluid media	Water 100 %
Fluid temperature <i>T</i>	20.00 °C
speed at duty point <i>n hydr. @ OP</i>	1,445 1/min
Impeller diameter <i>d imp.</i>	172 mm

Dimensions and dimensions drawings

Atmos GIGA-N 32/160.1-0,37/4

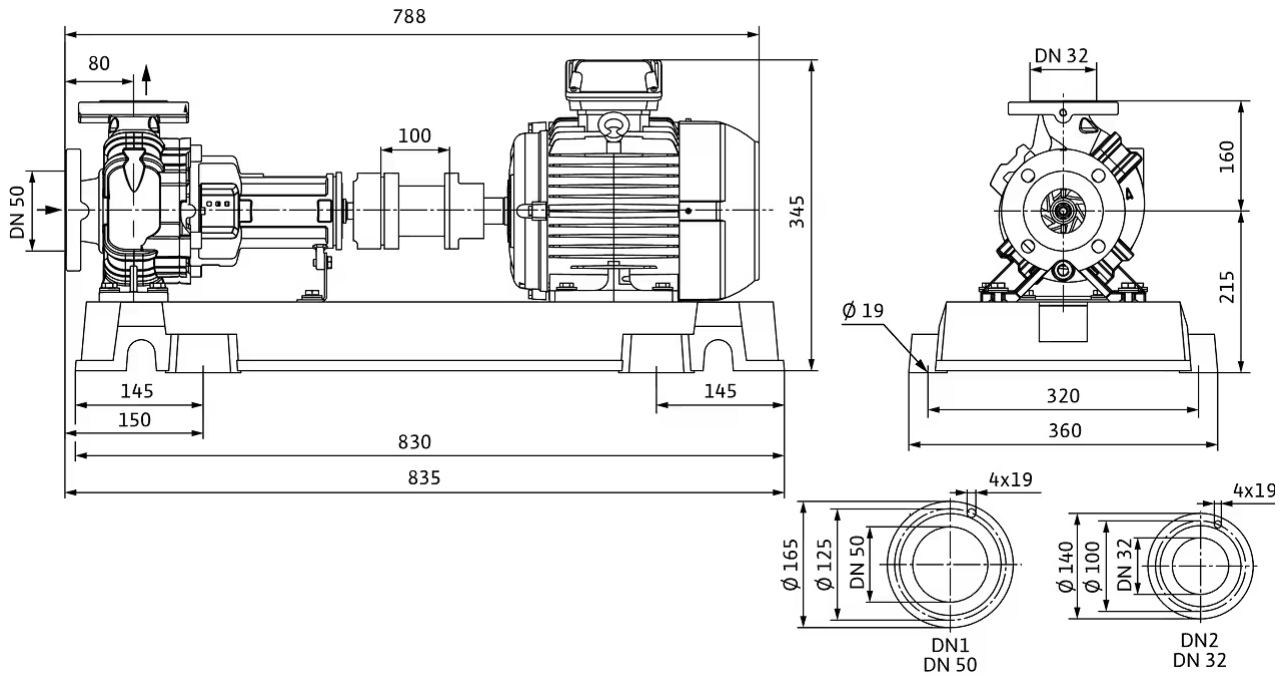

Wiring diagram

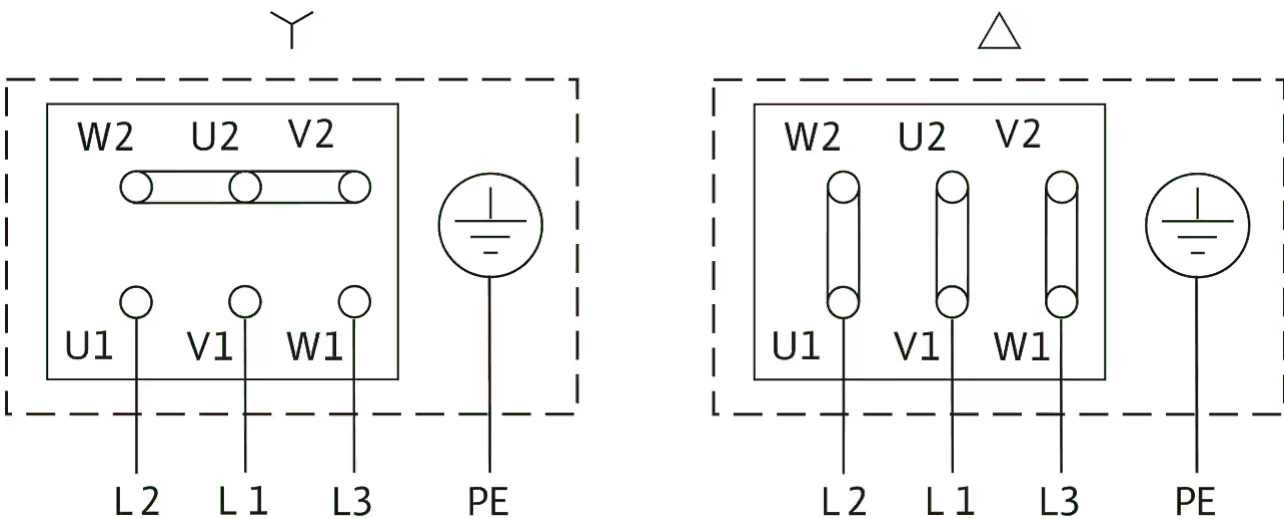

Δ : Connection diagram delta connection

Y: Connection diagram star connection

Motor protection switch required on-site. Check the direction of rotation! To change the direction of rotation, exchange any two phases.

$P_2 \leq 3$ kW 3~400 V Y

3~230 V Δ

$P_2 \geq 4$ kW 3~690 V Y

3~400 V Δ

After removing the bridges, Y- Δ start is possible.

Ordering information

Product data

Brand	Wilo
Product description	Atmos GIGA-N 32/160.1-0,37/4
Article number	6086592 
EAN number	4048482980485
Colour	Green
Minimum order quantity	1
Date of sales availability	2019-03-01

Packaging

Packaging type	Special pallet
Packaging property	Transport packaging
Pieces per pallet	1
Number per layer	1

Dimension, weight

Length with packaging	1200 mm
Length <i>L</i>	835 mm
Height with packaging	515 mm
Height <i>H</i>	375 mm
Width with packaging	500 mm
Width <i>W</i>	360 mm
Gross weight, approx. <i>m</i>	103 kg
Net weight, approx. <i>m</i>	92 kg

Tender text

Single-stage centrifugal pump as baseplate pump in accordance with EN 733, with axial suction ports and radial pressure ports for installation on a base. Pump with support foot and flanged bearing bracket, coupling, coupling guard and motor mounted to same baseplate.

IEC motor with 3 PTC thermistor sensors. Shaft sealing with bidirectional bellows mechanical seal. Grey cast iron housing, stainless steel shaft, grey cast iron impeller. Cathaphoretic coating as standard for all cast iron components in contact with fluid.

Coupling variants:

- > Spacer coupling (standard)
- > Elastic coupling (variant P5, at a reduced price)

Impeller variants (for an additional charge):

- > Bronze

> Stainless steel

NOTICE

The elastic coupling does not contain a spacer.

The spacer coupling is an elastic coupling with a spacer. The spacer reduces maintenance costs, and further motor orientation when changing the mechanical seal is not necessary.

Materials

Pump housing	5.1301/EN-GJL-250 KTL-coated
Impeller	Grey cast iron
Lantern	Grey cast iron
Shaft	Stainless steel
Shaft seal	AQ1EGG

Operating Data

Min. fluid temperature T_{\min}	-20 °C
Max. fluid temperature T_{\max}	140 °C
Maximum operating pressure p	16.0 bar
Max. ambient temperature T_{\max}	40 °C
Minimum efficiency index (MEI)	≥ 0.4

Motor data

Mains connection	3-400 V, 50 Hz
Voltage tolerance	± 10 %
Motor efficiency class	IE3
Rated power P_2	370 W
Rated speed n	1385 1/min
Rated current I_N	0.99 A
Power factor $\cos \varphi_{100}$	0.62
Motor efficiency 50% $\eta_M 50\%$	73 %
Motor efficiency 75% $\eta_M 75\%$	75 %
Motor efficiency 100% $\eta_M 100\%$	77.3 %
Protection class	IP55
Insulation class	F

Installation dimensions

Pipe connection on the suction side DN_s	DN 50
Pipe connection on the discharge side DN_d	DN 32

Ordering information

Brand	Wilo
Net weight, approx. m	92 kg
Product description	Atmos GIGA-N 32/160.1-0,37/4
Article number	6086592 

Electrical accessories

Pump control

Wilo-EFC

EFC0.37 3x380-480V 50/60Hz IP55	2193429
---------------------------------	---------

Pump control/accessories

Antenna GSM/GPRS

D-network dual-band antenna with 3 m cable	2533862
D-network tri-band antenna 10 m cable	2533863
D-network tri-band antenna 15 m cable	2533864
SMA/FME adapter	2545548

BMS base module

BMS base module	2533800
-----------------	---------

CC communication module BACnet

CC-communication module BACnet MS/TP (slave)	2537050
CC-communication module BACnet IP (slave)	2537051

Communication module CC

CC communication module	2533850
-------------------------	---------

Communication module GSM

GSM module	2533861
------------	---------

Communication module GSM (SC)

Communication module GSM (SC)	2542216
-------------------------------	---------

Communication module LON

Communication module LON	2533868
--------------------------	---------

Communication module LON (SC)

Communication module LON (SC)	2538243
-------------------------------	---------

Communication module ModBus

Communication module Modbus RTU	2533869
---------------------------------	---------

Communication module Profibus

Communication module Profibus DP	2533866
----------------------------------	---------

Connection cable control modules/signalling modules

Control modules connecting cable	2533790
Signalling modules connecting cable	2533890

DDG impulse selector

DDG impulse selector	2533770
----------------------	---------

Outdoor temperature sensor Pt 100

Outdoor temperature sensor Pt 100	2533772
-----------------------------------	---------

Output filter EFC (150-500 m cable length)

2.4 A sin IP54 Wilo-EFC filter	6084559
2.5 A sin IP00 Wilo-EFC filter	6084574
2.5 A sin IP20 Wilo-EFC filter	6084900

Pump signalling module

Signalling module pump 1-2	2533812
Signalling module pump 3-6	2533836

SC communication module BACnet

SC-communication module BACnet MS/TP (slave)	2538242
BACnet IP SC communication module	2553366

SC-HVAC signal board

SC-HVAC signal board	2119646
----------------------	---------

Signal converter retrofit kit

Signal converter 0-10 V / 0-20 mA	2534992
-----------------------------------	---------

Temperature module

Temperature module for systems with 4-6 pumps	2533771
Temperature module for systems with 1-3 pumps	2534991

Differential pressure detection

DDG (4-20mA)

Wilo-DDG 10 Signal Trans.(4-20mA)2G VP.	2136454
Wilo-DDG 20 Signal Trans.(4-20mA)2G VP.	2136456
Wilo-DDG 40 Signal Trans.(4-20mA)2G VP.	2136458
Wilo-DDG 60 Signal Trans.(4-20mA)2G VP.	2136460
Wilo-DDG 100 Signal Trans.(4-20mA)	2211740

DDG power supply unit

DDG power supply unit

501865293

DDG transducer

DDG transducer

501771990

Motor protection

PTC thermistor tripping unit

PTC thermistor tripping unit

509275993

Services

With Wilo as your partner, you can not only be sure of choosing high-quality product solutions, but also of benefiting from a comprehensive, worry-free package of well thought-out services. We collaborate to develop a service concept tailored to your individual needs; with our expertise and personal consultancy, we make sure that the operation of your systems is as energy-efficient, reliable and economical as possible. All the while our competent Wilo service technicians are ready to assist you with fast, reliable and on-time support.

Recommended services

Supervision Norm-/SCP pumps	2219322
Commissioning Norm-/SCP pumps	2160452
Maintenance BASIC Norm-/SCP pumps	2160467
Maintenance COMFORT Norm-/SCP pumps	2160482
Wilo-Live Assistant Service	2216415

More suitable services

Service Package L Norm-/SCP pumps	2219698
Service Package M Norm-/SCP pumps	2219669
Service Package S Norm-/SCP pumps	2219640
Extended Warranty Norm-/SCP pumps	2219591
Installation Norm-/SCP pumps	2219357
System Optimisation Norm-/SCP pumps	2219252
Energy Solutions Norm-/SCP pumps	2219287
Repair Norm-/SCP pumps	2219611