



Data sheet

Hydraulic data

Maximum operating pressure P_N	16 bar
Min. fluid temperature T_{\min}	-20 °C
Max. fluid temperature T_{\max}	140 °C
Min. ambient temperature T_{\min}	-15 °C
Max. ambient temperature T_{\max}	40 °C

Motor data

Mains connection	3~400 V, 50 Hz
Voltage tolerance	±10 %
Rated power P_2	22 kW
Motor efficiency class	IE3
Rated current I_N	41 A
Rated speed n	1470 1/min
Power factor $\cos \varphi_{100}$	0.77
Insulation class	F
Protection class motor	IP55

Installation dimensions

Pipe connection on the suction side DN_s	DN 125
Pipe connection on the discharge side DN_d	DN 100

Materials

Pump housing	Grey cast iron
Impeller	Grey cast iron
Shaft	Stainless steel
Mechanical seal	AQ1EGG
Lantern	Grey cast iron

Pump curves

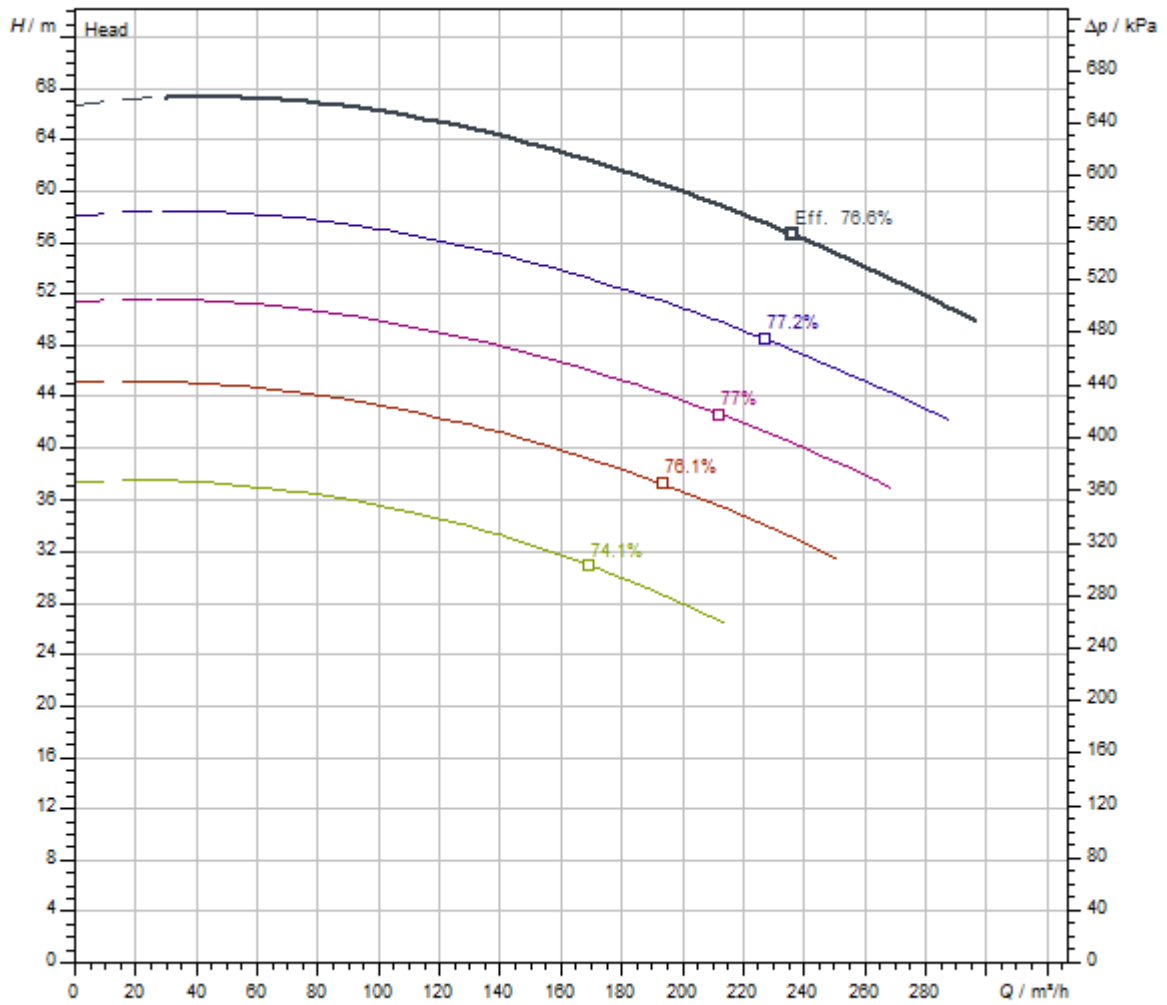

Standard	ISO 9906 3B
Fluid media	Water 100 %
Fluid temperature <i>T</i>	20.00 °C
speed at duty point <i>n hydr. @ OP</i>	1,487 1/min
Impeller diameter <i>d imp.</i>	415 mm

Dimensions and dimensions drawings

Atmos GIGA-N 100/400-22/4

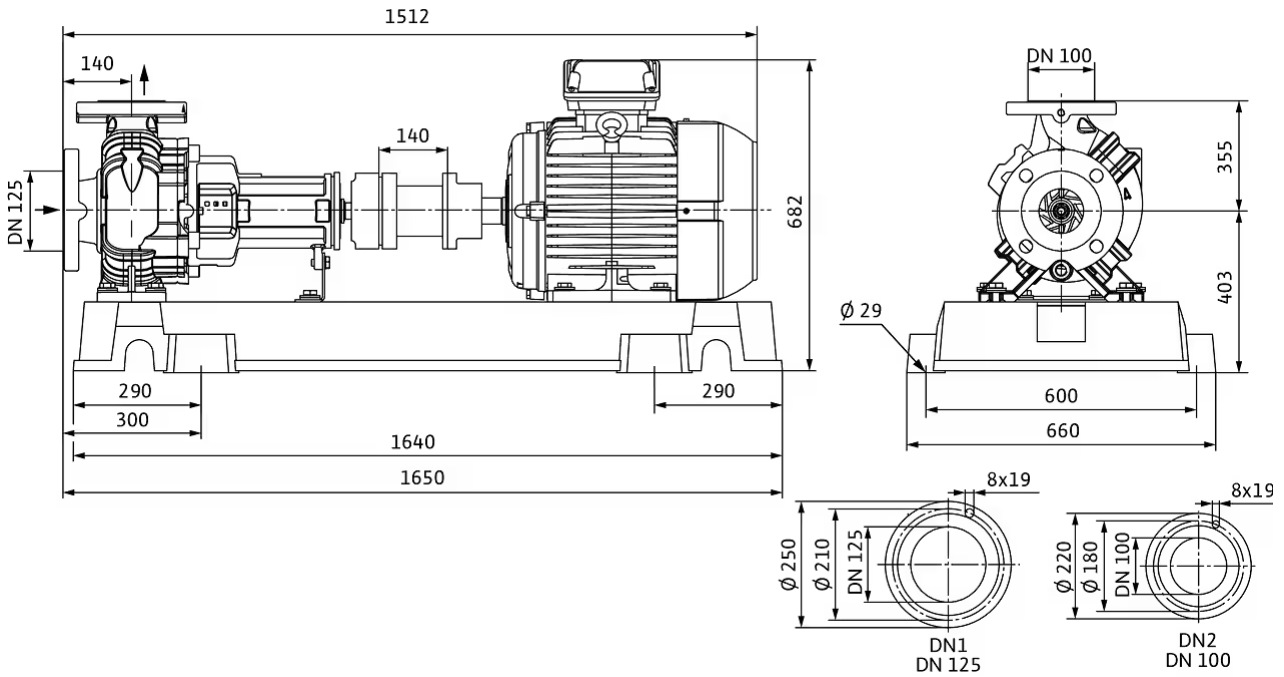

Wiring diagram



Δ: Connection diagram delta connection

Y: Connection diagram star connection

Motor protection switch required on-site. Check the direction of rotation! To change the direction of rotation, exchange any two phases.

$P_2 \leq 3 \text{ kW}$ 3~400 V Y

3~230 V Δ

$P_2 \geq 4 \text{ kW}$ 3~690 V Y

3~400 V Δ

After removing the bridges, Y-Δ start is possible.

Tender text

Single-stage centrifugal pump as baseplate pump in accordance with EN 733, with axial suction ports and radial pressure ports for installation on a base. Pump with support foot and flanged bearing bracket, coupling, coupling guard and motor mounted to same baseplate.

IEC motor with 3 PTC thermistor sensors. Shaft sealing with bidirectional bellows mechanical seal. Grey cast iron housing, stainless steel shaft, grey cast iron impeller. Cathaphoretic coating as standard for all cast iron components in contact with fluid.

Coupling variants:

- > Spacer coupling (standard)
- > Elastic coupling (variant P5, at a reduced price)

Impeller variants (for an additional charge):

- > Bronze

> Stainless steel

NOTICE

The elastic coupling does not contain a spacer.

The spacer coupling is an elastic coupling with a spacer. The spacer reduces maintenance costs, and further motor orientation when changing the mechanical seal is not necessary.

Materials

Pump housing	Grey cast iron
Impeller	Grey cast iron
Lantern	Grey cast iron
Shaft	Stainless steel
Shaft seal	AQ1EGG

Operating Data

Min. fluid temperature T_{\min}	-20 °C
Max. fluid temperature T_{\max}	140 °C
Maximum operating pressure p	16.0 bar
Max. ambient temperature T_{\max}	40 °C
Minimum efficiency index (MEI)	≥ 0.4

Motor data

Mains connection	3-400 V, 50 Hz
Voltage tolerance	± 10 %
Motor efficiency class	IE3
Rated power P_2	22000 W
Rated speed n	1470 1/min
Rated current I_N	41 A
Power factor $\cos \varphi_{100}$	0.77
Motor efficiency 50% $\eta_M 50\%$	92.3 %
Motor efficiency 75% $\eta_M 75\%$	93 %
Motor efficiency 100% $\eta_M 100\%$	93.2 %
Protection class	IP55
Insulation class	F

Installation dimensions

Pipe connection on the suction side DN_s	DN 125
Pipe connection on the discharge side DN_d	DN 100

Ordering information

Brand	Wilo
Net weight, approx. m	617 kg
Product description	Atmos GIGA-N 100/400-22/4
Article number	6086428 

Installation type

Continuous, infinitely variable control, differential pressure-sensitive CC-HVAC system

CC-HVAC system

CC-HVAC-System 2x43A-T34-SD-FC-BM	2527861
CC-HVAC-System 3x43A-T34-SD-FC-BM	2527862

Antenna GSM/GPRS

D-network dual-band antenna with 3 m cable	2533862
D-network tri-band antenna 10 m cable	2533863
D-network tri-band antenna 15 m cable	2533864

Outdoor temperature sensor Pt 100

Outdoor temperature sensor Pt 100	2533772
-----------------------------------	---------

DDG impulse selector

DDG impulse selector	2533770
----------------------	---------

BMS base module

BMS base module	2533800
-----------------	---------

CC communication module BACnet

CC-communication module BACnet IP (slave)	2537051
CC-communication module BACnet MS/TP (slave)	2537050

Communication module LON

Communication module LON	2533868
--------------------------	---------

Communication module ModBus

Communication module Modbus RTU	2533869
---------------------------------	---------

Communication module Profibus

Communication module Profibus DP	2533866
----------------------------------	---------

Communication module GSM

GSM module	2533861
------------	---------

Pump signalling module

Signalling module pump 1-2	2533812
Signalling module pump 3-6	2533836

Signal converter retrofit kit

Signal converter 0-10 V / 0-20 mA	2534992
-----------------------------------	---------

Connection cable control modules/signalling modules

Control modules connecting cable	2533790
Signalling modules connecting cable	2533890

DDG (4-20mA)

Wilo-DDG 10 Signal Trans.(4-20mA)2G VP.	2136454
Wilo-DDG 100 Signal Trans.(4-20mA)	2211740
Wilo-DDG 20 Signal Trans.(4-20mA)2G VP.	2136456
Wilo-DDG 40 Signal Trans.(4-20mA)2G VP.	2136458
Wilo-DDG 60 Signal Trans.(4-20mA)2G VP.	2136460

DDG transducer

DDG transducer	501771990
----------------	-----------

DDG power supply unit

DDG power supply unit	501865293
-----------------------	-----------

PTC thermistor tripping unit

PTC thermistor tripping unit	509275993
------------------------------	-----------

Continuous, infinitely variable control, temperature-dependent CC-HVAC system

CC-HVAC system

CC-HVAC-System 2x43A-T34-SD-FC-BM	2527861
CC-HVAC-System 3x43A-T34-SD-FC-BM	2527862

Antenna GSM/GPRS

D-network dual-band antenna with 3 m cable	2533862
D-network tri-band antenna 10 m cable	2533863
D-network tri-band antenna 15 m cable	2533864

Outdoor temperature sensor Pt 100

Outdoor temperature sensor Pt 100	2533772
-----------------------------------	---------

BMS base module

BMS base module	2533800
-----------------	---------

CC communication module BACnet

CC-communication module BACnet IP (slave)	2537051
CC-communication module BACnet MS/TP (slave)	2537050

Communication module LON

Communication module LON	2533868
--------------------------	---------

Communication module ModBus

Communication module Modbus RTU	2533869
---------------------------------	---------

Communication module Profibus

Communication module Profibus DP	2533866
----------------------------------	---------

Communication module GSM

GSM module	2533861
------------	---------

Pump signalling module

Signalling module pump 1-2	2533812
----------------------------	---------

Signalling module pump 3-6	2533836
----------------------------	---------

Signal converter retrofit kit

Signal converter 0-10 V / 0-20 mA	2534992
-----------------------------------	---------

Temperature module

Temperature module for systems with 1-3 pumps	2534991
---	---------

Temperature module for systems with 4-6 pumps	2533771
---	---------

Connection cable control modules/signalling modules

Control modules connecting cable	2533790
----------------------------------	---------

Signalling modules connecting cable	2533890
-------------------------------------	---------

PTC thermistor tripping unit

PTC thermistor tripping unit	509275993
------------------------------	-----------

Continuous, infinitely variable control, differential pressure-sensitive SC-HVAC system

SC/SC-FC-HVAC system

SC-FC-HVAC system 1x43A-FC-BM (star-delta-starting)	2545490
---	---------

SC-FC-HVAC system 2x43A-FC-BM (star-delta-starting)	2545491
---	---------

SC-FC-HVAC system 3x43A-FC-BM (star-delta-starting)	2545492
---	---------

SC-FC-HVAC system 4x43A-FC-BM (star-delta-starting)	2545493
---	---------

SC-HVAC system 1x43A-WM (star-delta-starting)	2545374
---	---------

SC-HVAC system 2x43A-WM (star-delta-starting)	2545375
---	---------

SC-HVAC system 3x43A-BM (star-delta-starting)	2545376
---	---------

SC-HVAC system 4x43A-BM (star-delta-starting)	2545377
---	---------

Antenna GSM/GPRS

D-network dual-band antenna with 3 m cable	2533862
D-network tri-band antenna 10 m cable	2533863
D-network tri-band antenna 15 m cable	2533864

Outdoor temperature sensor Pt 100

Outdoor temperature sensor Pt 100	2533772
-----------------------------------	---------

DDG impulse selector

DDG impulse selector	2533770
----------------------	---------

Communication module LON (SC)

Communication module LON (SC)	2538243
-------------------------------	---------

SC communication module BACnet

SC-communication module BACnet MS/TP (slave)	2538242
--	---------

Communication module GSM (SC)

Communication module GSM (SC)	2542216
-------------------------------	---------

Pump signalling module

Signalling module pump 1-2	2533812
Signalling module pump 3-6	2533836

SC-HVAC signal board

SC-HVAC signal board	2119646
----------------------	---------

DDG (4-20mA)

Wilo-DDG 10 Signal Trans.(4-20mA)2G VP.	2136454
Wilo-DDG 100 Signal Trans.(4-20mA)	2211740
Wilo-DDG 20 Signal Trans.(4-20mA)2G VP.	2136456
Wilo-DDG 40 Signal Trans.(4-20mA)2G VP.	2136458
Wilo-DDG 60 Signal Trans.(4-20mA)2G VP.	2136460

DDG transducer

DDG transducer	501771990
----------------	-----------

DDG power supply unit

DDG power supply unit	501865293
-----------------------	-----------

PTC thermistor tripping unit

--	--

PTC thermistor tripping unit	509275993
------------------------------	-----------

Continuous, infinitely variable control, temperature-dependent SC-HVAC system

SC/SC-FC-HVAC system

SC-FC-HVAC system 1x43A-FC-BM (star-delta-starting)	2545490
SC-FC-HVAC system 2x43A-FC-BM (star-delta-starting)	2545491
SC-FC-HVAC system 3x43A-FC-BM (star-delta-starting)	2545492
SC-FC-HVAC system 4x43A-FC-BM (star-delta-starting)	2545493
SC-HVAC system 1x43A-WM (star-delta-starting)	2545374
SC-HVAC system 2x43A-WM (star-delta-starting)	2545375
SC-HVAC system 3x43A-BM (star-delta-starting)	2545376
SC-HVAC system 4x43A-BM (star-delta-starting)	2545377

Antenna GSM/GPRS

D-network dual-band antenna with 3 m cable	2533862
D-network tri-band antenna 10 m cable	2533863
D-network tri-band antenna 15 m cable	2533864

Outdoor temperature sensor Pt 100

Outdoor temperature sensor Pt 100	2533772
-----------------------------------	---------

Communication module LON (SC)

Communication module LON (SC)	2538243
-------------------------------	---------

SC communication module BACnet

SC-communication module BACnet MS/TP (slave)	2538242
--	---------

Communication module GSM (SC)

Communication module GSM (SC)	2542216
-------------------------------	---------

Pump signalling module

Signalling module pump 1-2	2533812
Signalling module pump 3-6	2533836

SC-HVAC signal board

SC-HVAC signal board	2119646
----------------------	---------

PTC thermistor tripping unit

PTC thermistor tripping unit	509275993
------------------------------	-----------