

Data sheet

Hydraulic data

Maximum operating pressure P_N	16 bar
Min. fluid temperature T_{\min}	-20 °C
Max. fluid temperature T_{\max}	140 °C
Min. ambient temperature T_{\min}	-15 °C
Max. ambient temperature T_{\max}	40 °C

Motor data

Mains connection	3~400 V, 50 Hz
Voltage tolerance	±10 %
Rated power P_2	15 kW
Motor efficiency class	IE3
Rated current I_N	27.9 A
Rated speed n	1465 1/min
Power factor $\cos \varphi_{100}$	0.78
Insulation class	F
Protection class motor	IP55

Installation dimensions

Pipe connection on the suction side DN_s	DN 125
Pipe connection on the discharge side DN_d	DN 100

Materials

Pump housing	Grey cast iron
Impeller	Grey cast iron
Shaft	Stainless steel
Mechanical seal	AQ1EGG
Lantern	Grey cast iron

Pump curves

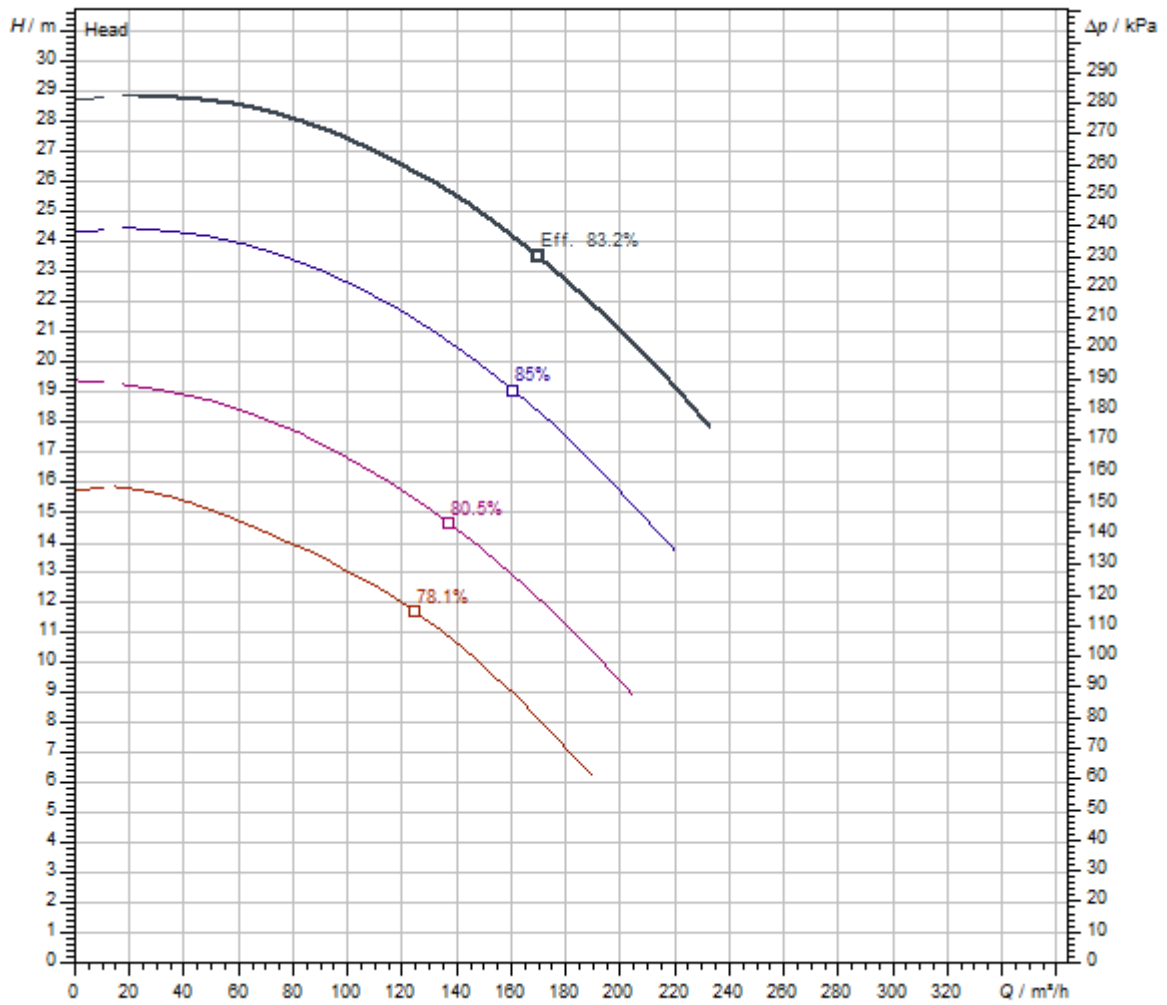

Standard	ISO 9906 3B
Fluid media	Water 100 %
Fluid temperature <i>T</i>	20.00 °C
speed at duty point <i>n hydr. @ OP</i>	1,473 1/min
Impeller diameter <i>d imp.</i>	278 mm

Dimensions and dimensions drawings

Atmos GIGA-N 100/250-15/4

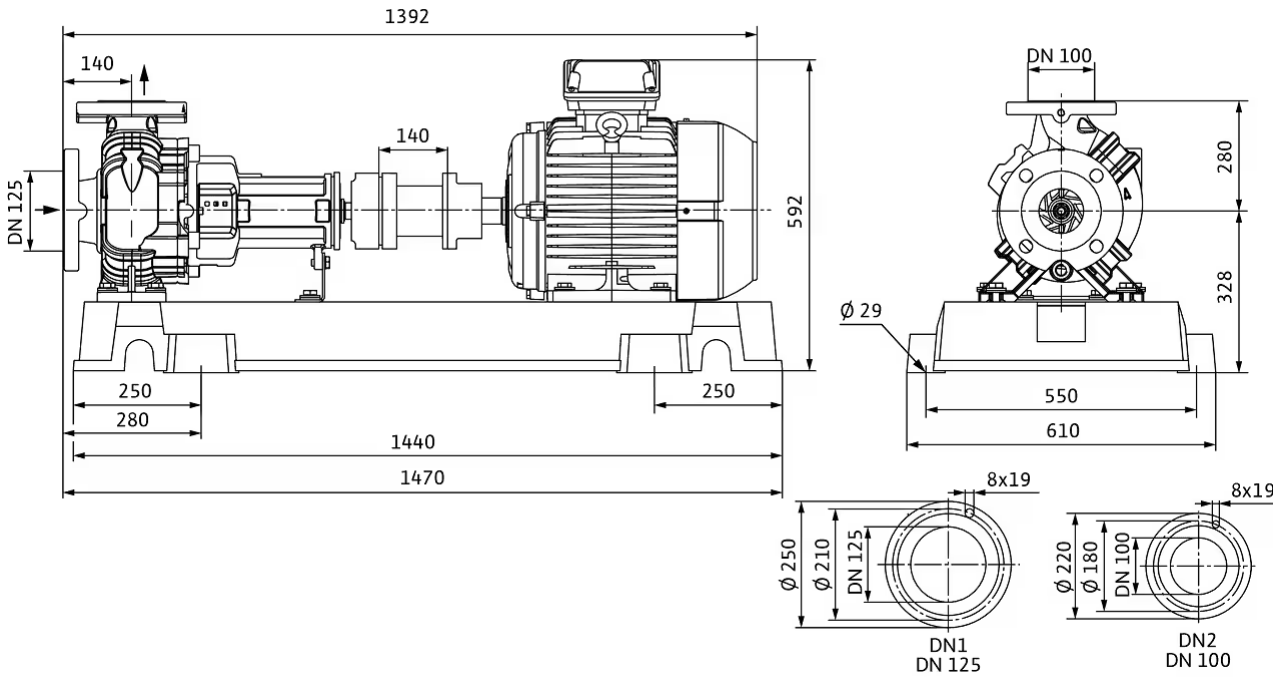

Wiring diagram



Δ: Connection diagram delta connection

Y: Connection diagram star connection

Motor protection switch required on-site. Check the direction of rotation! To change the direction of rotation, exchange any two phases.

$P_2 \leq 3 \text{ kW}$ 3~400 V Y

3~230 V Δ

$P_2 \geq 4 \text{ kW}$ 3~690 V Y

3~400 V Δ

After removing the bridges, Y-Δ start is possible.

Tender text

Single-stage centrifugal pump as baseplate pump in accordance with EN 733, with axial suction ports and radial pressure ports for installation on a base. Pump with support foot and flanged bearing bracket, coupling, coupling guard and motor mounted to same baseplate.

IEC motor with 3 PTC thermistor sensors. Shaft sealing with bidirectional bellows mechanical seal. Grey cast iron housing, stainless steel shaft, grey cast iron impeller. Cathaphoretic coating as standard for all cast iron components in contact with fluid.

Coupling variants:

- > Spacer coupling (standard)
- > Elastic coupling (variant P5, at a reduced price)

Impeller variants (for an additional charge):

- > Bronze

> Stainless steel

NOTICE

The elastic coupling does not contain a spacer.

The spacer coupling is an elastic coupling with a spacer. The spacer reduces maintenance costs, and further motor orientation when changing the mechanical seal is not necessary.

Materials

Pump housing	Grey cast iron
Impeller	Grey cast iron
Lantern	Grey cast iron
Shaft	Stainless steel
Shaft seal	AQ1EGG

Operating Data

Min. fluid temperature T_{min}	-20 °C
Max. fluid temperature T_{max}	140 °C
Maximum operating pressure p	16.0 bar
Max. ambient temperature T_{max}	40 °C
Minimum efficiency index (MEI)	≥0.4

Motor data

Mains connection	3-400 V, 50 Hz
Voltage tolerance	±10 %
Motor efficiency class	IE3
Rated power P_2	15000 W
Rated speed n	1465 1/min
Rated current I_N	27.9 A
Power factor $\cos \varphi_{100}$	0.78
Motor efficiency 50% $\eta_M 50\%$	92.2 %
Motor efficiency 75% $\eta_M 75\%$	92.5 %
Motor efficiency 100% $\eta_M 100\%$	92.3 %
Protection class	IP55
Insulation class	F

Installation dimensions

Pipe connection on the suction side DN_s	DN 125
Pipe connection on the discharge side DN_d	DN 100

Ordering information

Brand	Wilo
Net weight, approx. m	408 kg
Product description	Atmos GIGA-N 100/250-15/4
Article number	6086225

Installation type

Continuous, infinitely variable control, differential pressure-sensitive CC-HVAC system

CC-HVAC system

CC-HVAC-System 1x32A-T34-SD-FC-BM	2527848
CC-HVAC-System 2x32A-T34-SD-FC-BM	2527849
CC-HVAC-System 3x32A-T34-SD-FC-BM	2527850

Antenna GSM/GPRS

D-network dual-band antenna with 3 m cable	2533862
D-network tri-band antenna 10 m cable	2533863
D-network tri-band antenna 15 m cable	2533864

Outdoor temperature sensor Pt 100

Outdoor temperature sensor Pt 100	2533772
-----------------------------------	---------

DDG impulse selector

DDG impulse selector	2533770
----------------------	---------

BMS base module

BMS base module	2533800
-----------------	---------

CC communication module BACnet

CC-communication module BACnet IP (slave)	2537051
CC-communication module BACnet MS/TP (slave)	2537050

Communication module LON

Communication module LON	2533868
--------------------------	---------

Communication module ModBus

Communication module Modbus RTU	2533869
---------------------------------	---------

Communication module Profibus

Communication module Profibus DP	2533866
----------------------------------	---------

Communication module GSM

GSM module	2533861
------------	---------

Pump signalling module

Signalling module pump 1-2	2533812
Signalling module pump 3-6	2533836

Signal converter retrofit kit

Signal converter 0-10 V / 0-20 mA	2534992
-----------------------------------	---------

Connection cable control modules/signalling modules

Control modules connecting cable	2533790
Signalling modules connecting cable	2533890

DDG (4-20mA)

Wilo-DDG 10 Signal Trans.(4-20mA)2G VP.	2136454
Wilo-DDG 100 Signal Trans.(4-20mA)	2211740
Wilo-DDG 20 Signal Trans.(4-20mA)2G VP.	2136456
Wilo-DDG 40 Signal Trans.(4-20mA)2G VP.	2136458
Wilo-DDG 60 Signal Trans.(4-20mA)2G VP.	2136460

DDG transducer

DDG transducer	501771990
----------------	-----------

DDG power supply unit

DDG power supply unit	501865293
-----------------------	-----------

PTC thermistor tripping unit

PTC thermistor tripping unit	509275993
------------------------------	-----------

Continuous, infinitely variable control, temperature-dependent CC-HVAC system

CC-HVAC system

CC-HVAC-System 1x32A-T34-SD-FC-BM	2527848
CC-HVAC-System 2x32A-T34-SD-FC-BM	2527849
CC-HVAC-System 3x32A-T34-SD-FC-BM	2527850

Antenna GSM/GPRS

D-network dual-band antenna with 3 m cable	2533862
D-network tri-band antenna 10 m cable	2533863
D-network tri-band antenna 15 m cable	2533864

Outdoor temperature sensor Pt 100

Outdoor temperature sensor Pt 100	2533772
-----------------------------------	---------

BMS base module

BMS base module	2533800
-----------------	---------

CC communication module BACnet

CC-communication module BACnet IP (slave)	2537051
CC-communication module BACnet MS/TP (slave)	2537050
Communication module LON	
Communication module LON	2533868
Communication module ModBus	
Communication module Modbus RTU	2533869
Communication module Profibus	
Communication module Profibus DP	2533866
Communication module GSM	
GSM module	2533861
Pump signalling module	
Signalling module pump 1-2	2533812
Signalling module pump 3-6	2533836
Signal converter retrofit kit	
Signal converter 0-10 V / 0-20 mA	2534992
Temperature module	
Temperature module for systems with 1-3 pumps	2534991
Temperature module for systems with 4-6 pumps	2533771
Connection cable control modules/signalling modules	
Control modules connecting cable	2533790
Signalling modules connecting cable	2533890
PTC thermistor tripping unit	
PTC thermistor tripping unit	509275993
Continuous, infinitely variable control, differential pressure-sensitive SC-HVAC system	
SC/SC-FC-HVAC system	
SC-FC-HVAC system 1x32A-FC-BM (direct starting)	2545462
SC-FC-HVAC system 1x32A-FC-BM (star-delta-starting)	2545482
SC-FC-HVAC system 2x32A-FC-BM (direct starting)	2545463
SC-FC-HVAC system 2x32A-FC-BM (star-delta-starting)	2545483
SC-FC-HVAC system 3x32A-FC-BM (direct starting)	2545464
SC-FC-HVAC system 3x32A-FC-BM (star-delta-starting)	2545484

SC-FC-HVAC system 4x32A-FC-BM (direct starting)	2545465
SC-FC-HVAC system 4x32A-FC-BM (star-delta-starting)	2545485
SC-HVAC system 1x32A-WM (direct starting)	2545346
SC-HVAC system 1x32A-WM (star-delta-starting)	2545366
SC-HVAC system 2x32A-WM (direct starting)	2545347
SC-HVAC system 2x32A-WM (star-delta-starting)	2545367
SC-HVAC system 3x32A-BM (star-delta-starting)	2545368
SC-HVAC system 3x32A-WM (direct starting)	2545348
SC-HVAC system 4x32A-BM (star-delta-starting)	2545369
SC-HVAC system 4x32A-WM (direct starting)	2545349

Antenna GSM/GPRS

D-network dual-band antenna with 3 m cable	2533862
D-network tri-band antenna 10 m cable	2533863
D-network tri-band antenna 15 m cable	2533864

Outdoor temperature sensor Pt 100

Outdoor temperature sensor Pt 100	2533772
-----------------------------------	---------

DDG impulse selector

DDG impulse selector	2533770
----------------------	---------

Communication module LON (SC)

Communication module LON (SC)	2538243
-------------------------------	---------

SC communication module BACnet

SC-communication module BACnet MS/TP (slave)	2538242
--	---------

Communication module GSM (SC)

Communication module GSM (SC)	2542216
-------------------------------	---------

Pump signalling module

Signalling module pump 1-2	2533812
Signalling module pump 3-6	2533836

SC-HVAC signal board

SC-HVAC signal board	2119646
----------------------	---------

DDG (4-20mA)

Wilo-DDG 10 Signal Trans.(4-20mA)2G VP.	2136454
Wilo-DDG 100 Signal Trans.(4-20mA)	2211740

Wilo-DDG 20 Signal Trans.(4-20mA)2G VP.	2136456
Wilo-DDG 40 Signal Trans.(4-20mA)2G VP.	2136458
Wilo-DDG 60 Signal Trans.(4-20mA)2G VP.	2136460

DDG transducer

DDG transducer	501771990
----------------	-----------

DDG power supply unit

DDG power supply unit	501865293
-----------------------	-----------

PTC thermistor tripping unit

PTC thermistor tripping unit	509275993
------------------------------	-----------

Continuous, infinitely variable control, temperature-dependent SC-HVAC system

SC/SC-FC-HVAC system

SC-FC-HVAC system 1x32A-FC-BM (direct starting)	2545462
SC-FC-HVAC system 1x32A-FC-BM (star-delta-starting)	2545482
SC-FC-HVAC system 2x32A-FC-BM (direct starting)	2545463
SC-FC-HVAC system 2x32A-FC-BM (star-delta-starting)	2545483
SC-FC-HVAC system 3x32A-FC-BM (direct starting)	2545464
SC-FC-HVAC system 3x32A-FC-BM (star-delta-starting)	2545484
SC-FC-HVAC system 4x32A-FC-BM (direct starting)	2545465
SC-FC-HVAC system 4x32A-FC-BM (star-delta-starting)	2545485
SC-HVAC system 1x32A-WM (direct starting)	2545346
SC-HVAC system 1x32A-WM (star-delta-starting)	2545366
SC-HVAC system 2x32A-WM (direct starting)	2545347
SC-HVAC system 2x32A-WM (star-delta-starting)	2545367
SC-HVAC system 3x32A-BM (star-delta-starting)	2545368
SC-HVAC system 3x32A-WM (direct starting)	2545348
SC-HVAC system 4x32A-BM (star-delta-starting)	2545369
SC-HVAC system 4x32A-WM (direct starting)	2545349

Antenna GSM/GPRS

D-network dual-band antenna with 3 m cable	2533862
D-network tri-band antenna 10 m cable	2533863
D-network tri-band antenna 15 m cable	2533864

Outdoor temperature sensor Pt 100

Outdoor temperature sensor Pt 100	2533772
-----------------------------------	---------

Communication module LON (SC)

Communication module LON (SC)	2538243
-------------------------------	---------

SC communication module BACnet

SC-communication module BACnet MS/TP (slave)	2538242
--	---------

Communication module GSM (SC)

Communication module GSM (SC)	2542216
-------------------------------	---------

Pump signalling module

Signalling module pump 1-2	2533812
----------------------------	---------

Signalling module pump 3-6	2533836
----------------------------	---------

SC-HVAC signal board

SC-HVAC signal board	2119646
----------------------	---------

PTC thermistor tripping unit

PTC thermistor tripping unit	509275993
------------------------------	-----------