



Data sheet

Hydraulic data

Maximum operating pressure P_N	10 bar
Discharge port	Rp 1
Min. fluid temperature T_{min}	-20 °C
Max. fluid temperature T_{max}	90 °C
Min. ambient temperature T_{min}	-15 °C
Max. ambient temperature T_{max}	50 °C

Motor data

Mains connection	1~230 V, 50 Hz
Voltage tolerance	±10 %
Rated power P_2	0.55 kW
Rated current I_N	3.6 A
Rated speed n	2900 1/min
Insulation class	F
Protection class motor	IP55

Materials

Pump housing	Stainless steel
Shaft	Stainless steel
Shaft seal	BQ1VGG
Gasket material	FKM
Impeller	Stainless steel

Installation dimensions

Pipe connection on the suction side D_Ns	Rp 1
Pipe connection on the discharge side D_Nd	Rp 1

Pump curves

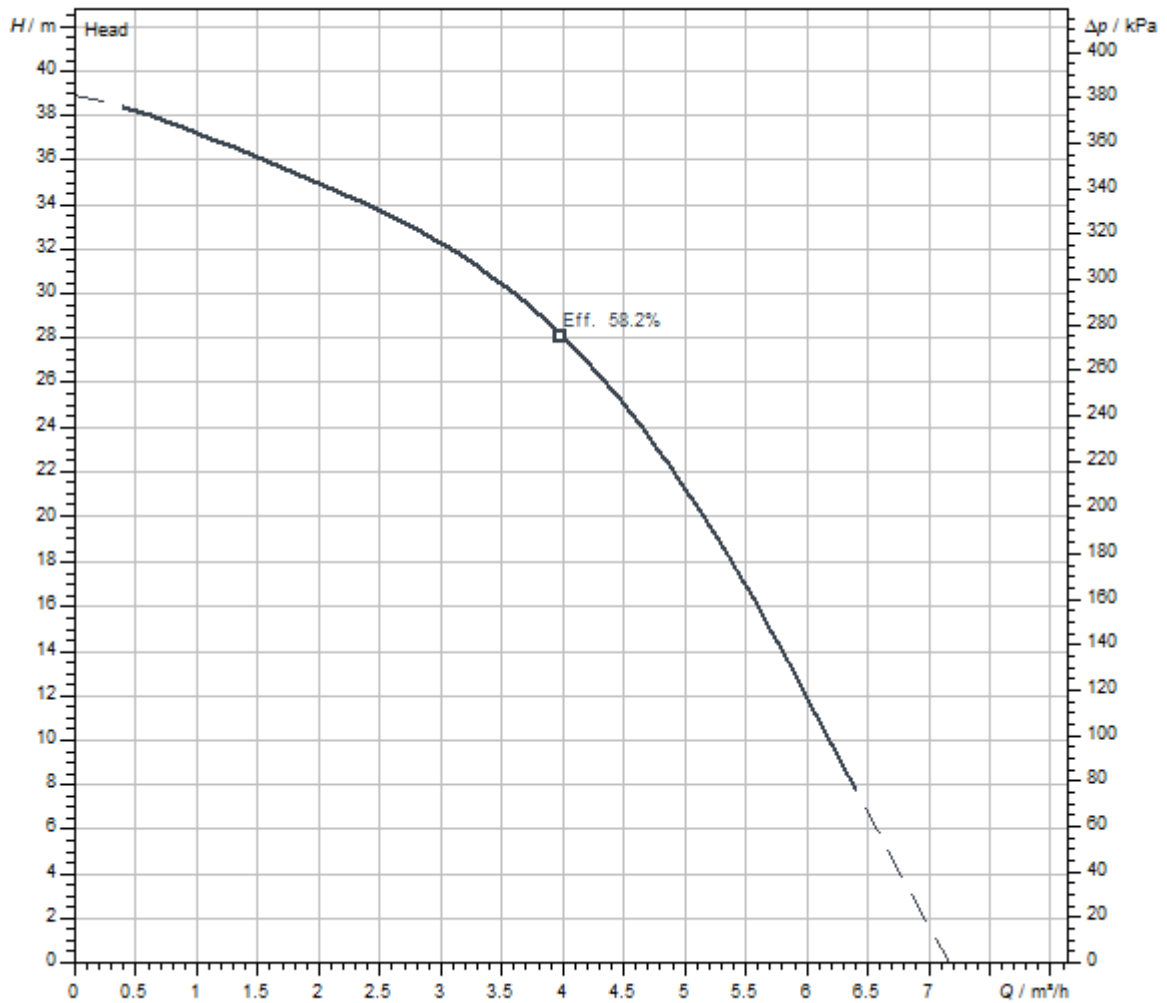

Fluid media	Water 100 %
Fluid temperature <i>T</i>	20.00 °C
speed at duty point <i>n hydr. @ OP</i>	2,900 1/min

Dimensions and dimensions drawings

Medana CH1-L.404-2/V/A/10T

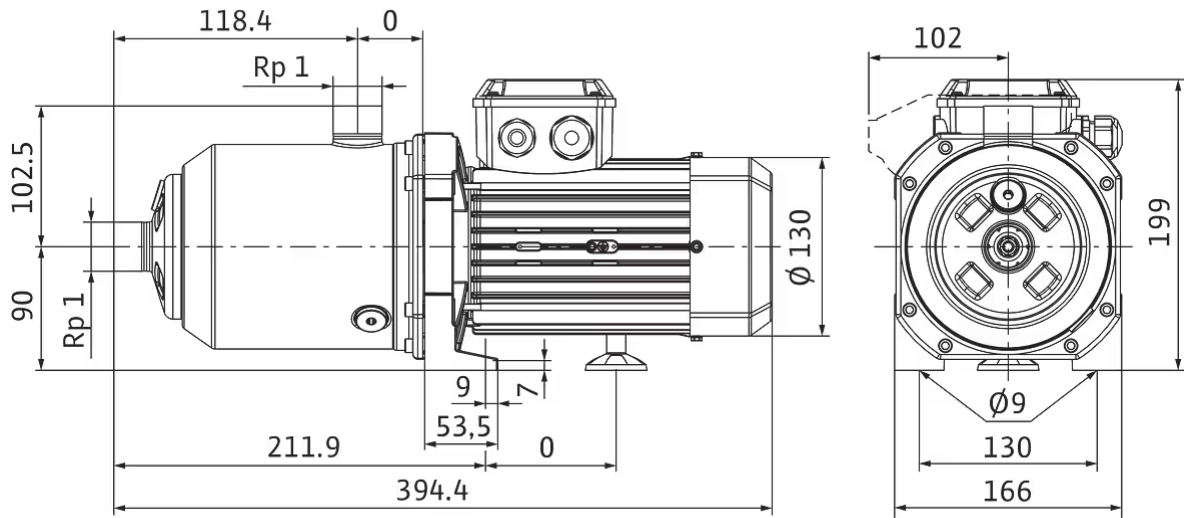

Wiring diagram

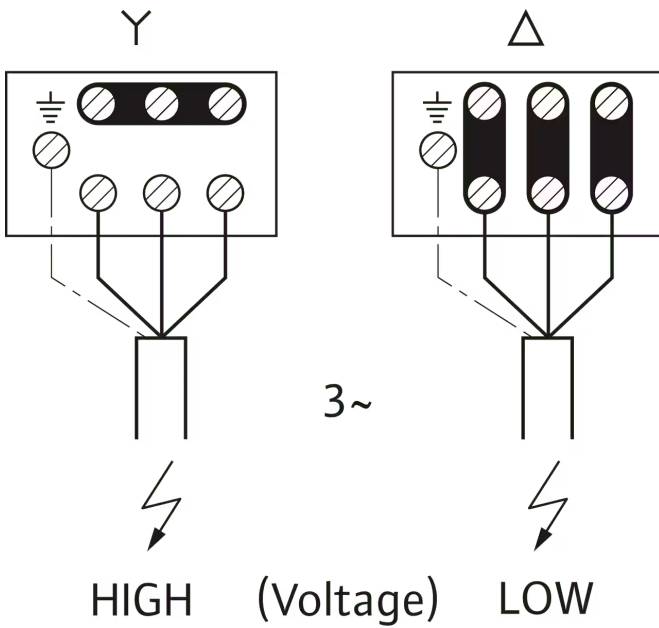

Tender text

The non-self-priming horizontal multistage pump reaches high hydraulic performances. Its compact and robust design with corrosion-resistant components and the usability in ambient temperatures up to 50°C offers a big field of application for pump integration into larger systems.

The pump is suitable for water supply and pressure boosting, industrial circulation systems, process water and cooling water circulation systems. It can also be used in washing systems as well as for irrigation.

Special features/Product advantages

- Easy and fast commissioning/maintenance thanks to big holes for pump-filling and emptying
- High reliability in terms of robustness and noise thanks to the neck ring design and corrosion-resistant lantern with cathophoretic coating
- Compact design for an easy integration
- All hydraulic parts which come into contact with the fluid, such as stage chambers, impellers and diffusers and the pump housing are made of stainless steel
- Drinking water approval for all components that come in contact with the fluid (EPDM version)

Scope of delivery

- Pump
- Installation and operating instructions

Operating Data

Product data

Maximum operating pressure P_N	10 bar
Min. fluid temperature T_{min}	-20 °C
Max. fluid temperature T_{max}	90 °C
Max. ambient temperature T_{max}	50 °C

Motor data

Mains connection	1~230 V, 50 Hz
Voltage tolerance	±10 %
Rated power P_2	0.55 kW
Rated current I_N	3.6 A
Rated speed n	2900 1/min
Insulation class	F
Protection class	IP55
Motor efficiency class	IE2

Materials

Pump housing	Stainless steel
Impeller	Stainless steel
Shaft	Stainless steel
Shaft seal	BQ1VGG
Gasket material	FKM

Installation dimensions

Pipe connection on the suction side D_Ns	Rp 1
Pipe connection on the discharge side D_Nd	Rp 1

Ordering information

Brand	Wilo
Product description	Medana CH1-L.404-2/V/A/10T
Net weight, approx. m	10.1 kg
Article number	4235340 

Electrical accessories

Pump control/accessories

Low-water cut-out switchgear kit for domestic water systems

low-water cut-out switchgear kit WMS G 1¼	4204510
low-water cut-out switchgear kit WMS G2	4204512

Pressure control

Pressure sensor for systems

Pressure sensor, 0 - 6 bar	2550660
Pressure sensor, 0 - 10 bar	2550661
Pressure sensor, 0 - 16 bar	2550662
Pressure sensor, 0 - 25 bar	2550663
Pressure sensor, 0 - 40 bar	2550664

Level control

Float switch WA

Float switch WA65 with 5 m cable	503211390
Float switch WA65 with 10 m cable	503211893
Float switch WA65 with 20 m cable	2004431
Float switch WA65 with 30 m cable	2004432
Float switch WA KR1 S with 5 m cable	6082806
Float switch WA KR1 S with 10 m cable	6082807

Float switch WA-EK

Float switch WA EK 65, 5 m cable	503211698
Float switch WA EK 65, 10 m cable	2005516
Float switch WA EK 65, 20 m cable	2005517

Float switch WAO

Float switch WAO 65, 5 m cable	503211595
Float switch WAO 65, 10 m cable	2006027
Float switch WAO 65, 20 m cable	2004429
Float switch WAO 65, 30 m cable	2004430

Float switch WAO-EK

Float switch WAO EK 65, 20 m cable	2005626
------------------------------------	---------

Immersion probe

Submersible electrode, 3 m	500183799
Submersible electrode, 4 m	2516278
Submersible electrode, 5 m	500937990
Submersible electrode, 10 m	2501937
Submersible electrode, 20 m	2516283
Submersible electrode, 25 m	2000601
Submersible electrode, 30 m	2514045
Submersible electrode, 35 m	2516284
Submersible electrode, 40 m	2516285
Submersible electrode, 50 m	2500315
Submersible electrode without cable	64873

Motor protection**PTC thermistor tripping unit**

PTC thermistor tripping unit	509275993
------------------------------	-----------