



Data sheet

Hydraulic data

Minimum efficiency index (MEI)	≥0.4
Maximum operating pressure P_N	16 bar
Min. fluid temperature T_{min}	-20 °C
Max. fluid temperature T_{max}	120 °C
Min. ambient temperature T_{min}	0 °C
Max. ambient temperature T_{max}	50 °C

Drive

Mains connection	3~400 V, 50/60 Hz
Number of poles	4
Motor efficiency class	IE5
Rated power P_2	0.55 kW
Rated current I_N	1.2 A
Rated speed n	2000 1/min
Max. speed n_{max}	2000 1/min
Power consumption $P_{1 max}$	700 W
Emitted interference	EN 61800-3
Interference resistance	EN 61800-3
Insulation class	F
Protection class motor	IP55
Threaded cable connection	1 x M25x1.5

Materials

Pump housing	Grey cast iron
Impeller	PPE/PS-GF30
Shaft	Stainless steel
Shaft seal	AQ1EGG
Lantern	5.1301/EN-GJL-250 KTL-coated

Approved liquids (other liquids upon request)

Heating water (as per VDI 2035)	yes
Heat carrier oil	Special version at additional charge
Cooling and cold water circulation systems	yes
Water-glycol mixtures (at 20 – 40 vol. % glycol and fluid temperature ≤ 40 °C)	yes

Installation dimensions

Port-to-port length L_0	340 mm
Pipe connection on the suction side DN_s	DN 65
Pipe connection on the discharge side DN_d	DN 65

Pump curves

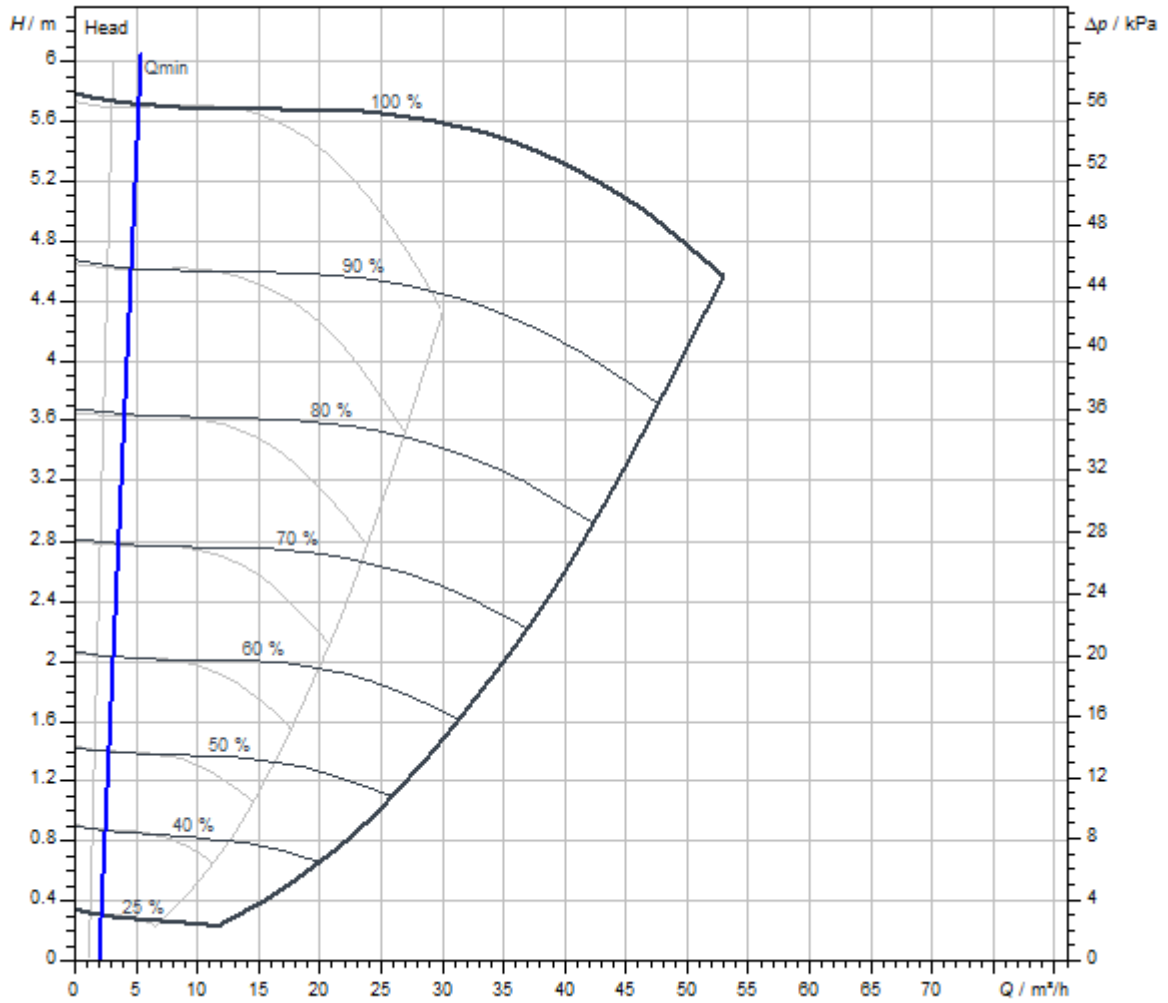

Fluid media	Water 100 %
Fluid temperature <i>T</i>	20.00 °C
speed at duty point <i>n hydr. @ OP</i>	2,001 1/min

Dimensions and dimensions drawings

Yonos GIGA2.0-D 65/1-5/0,55

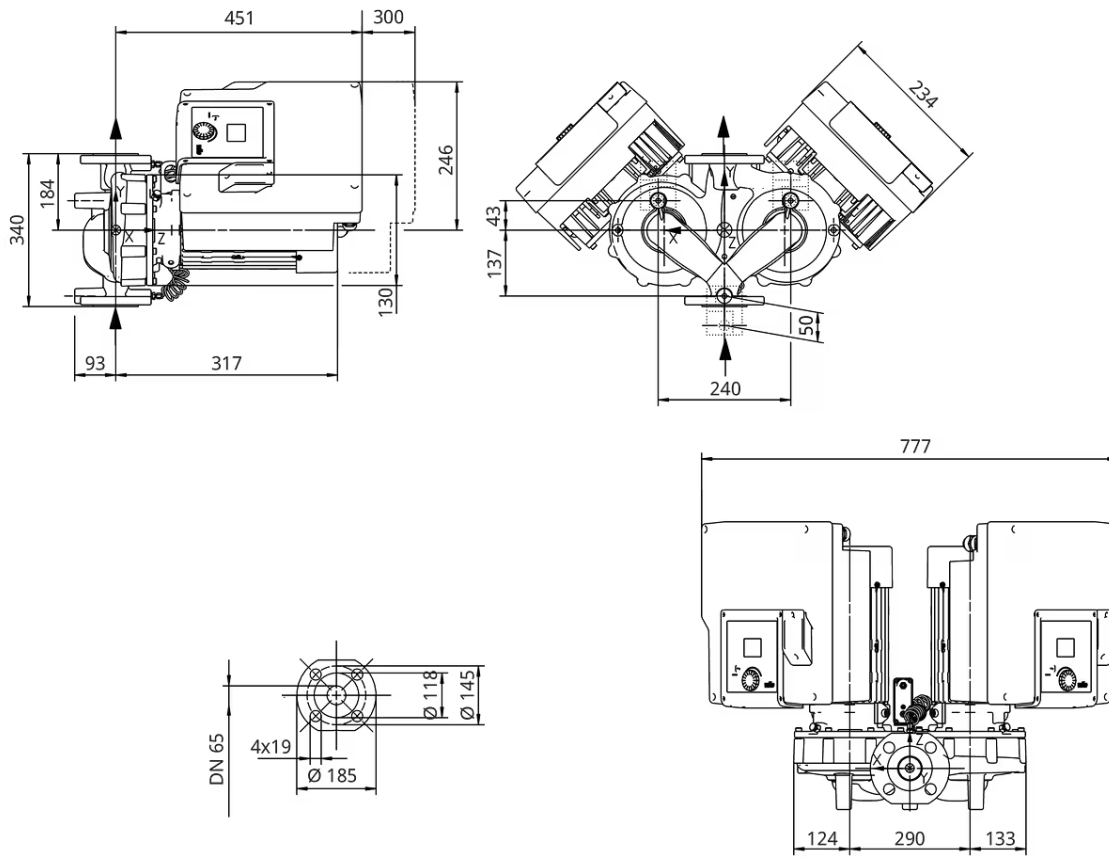

Wiring diagram

3~ 380 V...440 V, 50/60 Hz

3~380V...440V, 50/60 Hz

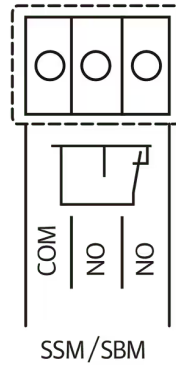
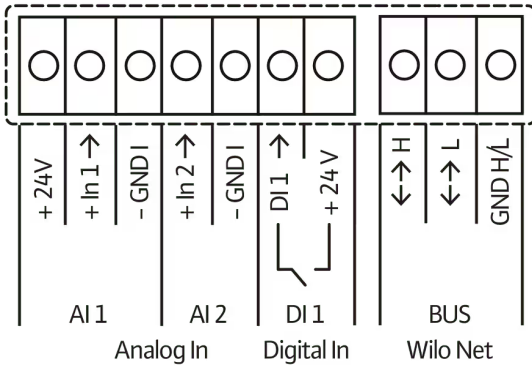
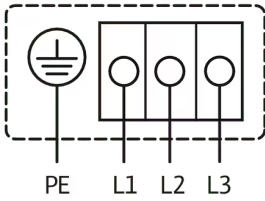

Tender text

In-line pump with high energy efficiency with EC motor of energy efficiency class IE5 in accordance with IEC 60034-30-2, hydraulics with minimum efficiency index $MEI \geq 0.4$ and electronic power adjustment in glanded pump design. The pump is configured as a single-stage low-pressure centrifugal pump with flange connection and mechanical seal. The **Yonos GIGA2.0-D** has been predominantly designed for pumping heating water (acc. to VDI 2035), cold water and water-glycol mixtures without abrasive substances in heating, air conditioning and cooling systems.

Design:

- > Single-stage low-pressure centrifugal pump with one-piece shaft in monobloc design
- > Spiral housing in in-line design (suction and discharge ports with the same flanges in a line)
- > PN 16 flange – in accordance with EN 1092-2
- > Pressure measuring connections (R 1/8) for mounted differential pressure sensor (version ...-R1 without differential pressure sensor)
- > Pump housing and lantern/motor flange with cataphoretic coating as standard
- > Mechanical seal for pumping water up to $T_{max.} = +120\text{ °C}$. A glycol admixture of 20 % to +40 % by volume is permitted up to $T \leq +40\text{ °C}$. An alternative mechanical seal must be provided in water-glycol mixtures with glycol proportions > 40 % up to max. 50 % by volume and a fluid temperature of > +40 °C up to max. +120 °C or fluids other than water. When using water-glycol mixtures, the use of an S1 variant with a corresponding mechanical seal is generally recommended.
- > Connection voltages:
 - > 3~440 V $\pm 10\%$ 50/60 Hz; 3~400 V $\pm 10\%$ 50/60 Hz; 3~380 V -5 % +10 % 50/60 Hz
 - > Version M-: 1~220 V ... 240 V ($\pm 10\%$), 50/60 Hz
- > Compliance with electromagnetic compatibility without additional measures
 - > Interference emission for residential environment according to EN 61800-3:2018
 - > Interference immunity for industrial environments according to EN 61800-3:2018

Control modes:

- > Variable differential pressure (**dp-v**)
- > Constant differential pressure (**dp-c**)
- > Constant speed (**n-const.**)
- > User-defined **PID** control

Functions:

- > **Operating modes of twin-head pump:**
 - Main/standby operation**, efficiency-optimised **parallel operation** for dp-c and dp-v
- > Integrated **full motor protection**

Display in the "Home screen" of the graphic display:

- > Control mode currently set
- > Current setpoint
- > Current actual value
- > Current volume flow (only if a differential pressure sensor is connected)
- > Current power consumption

Version:

- > **1 analogue input:** 0 ... 10 V, 2 ... 10 V, 0 ... 20 mA, 4 ... 20 mA only for sensor value from differential pressure sensor
- > **1 analogue input:** 0 ... 10 V, 2 ... 10 V, 0 ... 20 mA, 4 ... 20 mA only for external setpoint sensor
- > **1 digital input** (Ext. OFF)
- > **2 Signal relays** for **run signals and fault messages**
- > **Slot for Wilo-CIF modules** with interfaces for building automation (BA) (optional accessories: CIF modules Ethernet, Modbus RTU, BACnet MS/TP, LON, PLR, CAN)
- > **Wilo Net** as Wilo system bus for communication during twin-head pump operation
- > **Automatic emergency operation** with definable pump speed for exceptional circumstances, e.g. bus communication or sensor value malfunction
- > **Rotatable, graphic colour display** (2 inches) with one button manual operation level
- > Integrated **dual pump management** (twin-head pumps are prewired) connection via Wilo Net
- > **Cable break detection** when using an analogue signal (in connection with 2 ... 10 V or 4 ... 20 mA)
- > Standard **condensate drainage holes** in the motor housing (closed upon delivery)
- > **Air vent valve** on the lantern

Scope of delivery:

- > Pump
- > Installation and operating instructions and declaration of conformity

Accessories must be ordered separately:

3 mounting brackets with fixation material for installation on a base

- > Blind flanges for twin-head pump housing
- > For connection to building automation:
 - > CIF module PLR
 - > CIF module LON
 - > CIF module BACnet MS/TP
 - > Modbus RTU CIF module
 - > CIF module CANopen
 - > CIF module Ethernet Multi-protocol (Modbus TCP, BACnet/IP)
 - > Connection M12 RJ45 CIF Ethernet
- > Differential pressure sensor DPS 2 ... 10 V
- > Differential pressure sensor DPS 4 ... 20 mA

Operating Data

Min. fluid temperature T_{\min}	-20 °C
Max. fluid temperature T_{\max}	120 °C
Min. ambient temperature T_{\min}	0 °C
Max. ambient temperature T_{\max}	50 °C
Maximum operating pressure P_N	16 bar
Minimum efficiency index (MEI)	≥ 0.4

Motor data

Motor efficiency class	IE5
Emitted interference	EN 61800-3
Interference resistance	EN 61800-3
Mains connection	3~400 V, 50/60 Hz
Rated power P_2	550 W
Max. speed n_{\max}	2000 1/min
Rated current I_N	1.2 A
Insulation class	F
Protection class motor	IP55
Motor protection	PTC integrated

Materials

Pump housing	Grey cast iron
Impeller	PPE/PS-GF30
Shaft	Stainless steel
Shaft seal	AQ1EGG
Lantern	5.1301/EN-GJL-250 KTL-coated

Installation dimensions

Pipe connection on the suction side DN_s	DN 65
Pipe connection on the discharge side DN_d	DN 65
Port-to-port length L_0	340 mm

Ordering information

Brand	Wilo
Product description	Yonos GIGA2.0-D 65/1-5/0,55
Net weight, approx. m	62.8 kg
Article number	2205881 

Installation type

Continuous, infinitely variable control, differential pressure-sensitive CCe-HVAC system

CCe-HVAC system

CCe-HVAC system 1 x 0.37	2536646
CCe-HVAC system 2 x 0.37	2536647
CCe-HVAC system 3 x 0.37	2536648
CCe-HVAC system 4 x 0.37	2536649
CCe-HVAC system 5 x 0.37	2536650
CCe-HVAC system 6 x 0.37	2536651

Antenna GSM/GPRS

D-network dual-band antenna with 3 m cable	2533862
D-network tri-band antenna 10 m cable	2533863
D-network tri-band antenna 15 m cable	2533864

DDG impulse selector

DDG impulse selector	2533770
----------------------	---------

BMS base module

BMS base module	2533800
-----------------	---------

CC communication module BACnet

CC-communication module BACnet IP (slave)	2537051
CC-communication module BACnet MS/TP (slave)	2537050

Communication module LON

Communication module LON	2533868
--------------------------	---------

Communication module ModBus

Communication module Modbus RTU	2533869
---------------------------------	---------

Communication module Profibus

Communication module Profibus DP	2533866
----------------------------------	---------

Communication module CC

CC communication module	2533850
-------------------------	---------

Communication module GSM

GSM module	2533861
------------	---------

Pump signalling module

Signalling module pump 1-2	2533812
Signalling module pump 3-6	2533836

Signal converter retrofit kit

Signal converter 0-10 V / 0-20 mA	2534992
-----------------------------------	---------

Connection cable control modules/signalling modules

Control modules connecting cable	2533790
Signalling modules connecting cable	2533890

DDG transducer

DDG transducer	501771990
----------------	-----------

DDG power supply unit

DDG power supply unit	501865293
-----------------------	-----------

Extension kit differential pressure sensor for Y-piece application

Extension for DDG-kit	2166098
-----------------------	---------

Continuous, infinitely variable control, temperature-dependent CCe-HVAC system

CCe-HVAC system

CCe-HVAC system 1 x 0.37	2536646
CCe-HVAC system 2 x 0.37	2536647
CCe-HVAC system 3 x 0.37	2536648
CCe-HVAC system 4 x 0.37	2536649
CCe-HVAC system 5 x 0.37	2536650
CCe-HVAC system 6 x 0.37	2536651

Antenna GSM/GPRS

D-network dual-band antenna with 3 m cable	2533862
D-network tri-band antenna 10 m cable	2533863
D-network tri-band antenna 15 m cable	2533864

BMS base module

BMS base module	2533800
-----------------	---------

CC communication module BACnet

CC-communication module BACnet IP (slave)	2537051
CC-communication module BACnet MS/TP (slave)	2537050

Communication module LON

Communication module LON	2533868
--------------------------	---------

Communication module ModBus

Communication module Modbus RTU	2533869
---------------------------------	---------

Communication module Profibus

Communication module Profibus DP	2533866
----------------------------------	---------

Communication module CC

CC communication module	2533850
-------------------------	---------

Communication module GSM

GSM module	2533861
------------	---------

Pump signalling module

Signalling module pump 1-2	2533812
----------------------------	---------

Signalling module pump 3-6	2533836
----------------------------	---------

Signal converter retrofit kit

Signal converter 0-10 V / 0-20 mA	2534992
-----------------------------------	---------

Temperature module

Temperature module for systems with 1-3 pumps	2534991
---	---------

Temperature module for systems with 4-6 pumps	2533771
---	---------

Connection cable control modules/signalling modules

Control modules connecting cable	2533790
----------------------------------	---------

Signalling modules connecting cable	2533890
-------------------------------------	---------

Continuous, infinitely variable control, differential pressure-sensitive SCe-HVAC system

SCe-HVAC system

SCe-HVAC system 1x10A-WM	2545254
--------------------------	---------

SCe-HVAC system 2x10A-WM	2545255
--------------------------	---------

SCe-HVAC system 3x10A-WM	2545256
--------------------------	---------

SCe-HVAC system 4x10A-WM	2545257
--------------------------	---------

Antenna GSM/GPRS

D-network dual-band antenna with 3 m cable	2533862
--	---------

D-network tri-band antenna 10 m cable	2533863
---------------------------------------	---------

D-network tri-band antenna 15 m cable	2533864
---------------------------------------	---------

DDG impulse selector

DDG impulse selector	2533770
----------------------	---------

Communication module LON (SC)

Communication module LON (SC)	2538243
-------------------------------	---------

SC communication module BACnet

SC-communication module BACnet MS/TP (slave)	2538242
--	---------

Communication module GSM (SC)

Communication module GSM (SC)	2542216
-------------------------------	---------

Pump signalling module

Signalling module pump 1-2	2533812
----------------------------	---------

Signalling module pump 3-6	2533836
----------------------------	---------

SC-HVAC signal board

SC-HVAC signal board	2119646
----------------------	---------

DDG transducer

DDG transducer	501771990
----------------	-----------

DDG power supply unit

DDG power supply unit	501865293
-----------------------	-----------

Extension kit differential pressure sensor for Y-piece application

Extension for DDG-kit	2166098
-----------------------	---------

Continuous, infinitely variable control, temperature-dependent SCe-HVAC system

SCe-HVAC system

SCe-HVAC system 1x10A-WM	2545254
--------------------------	---------

SCe-HVAC system 2x10A-WM	2545255
--------------------------	---------

SCe-HVAC system 3x10A-WM	2545256
--------------------------	---------

SCe-HVAC system 4x10A-WM	2545257
--------------------------	---------

Antenna GSM/GPRS

D-network dual-band antenna with 3 m cable	2533862
--	---------

D-network tri-band antenna 10 m cable	2533863
---------------------------------------	---------

D-network tri-band antenna 15 m cable	2533864
---------------------------------------	---------

Communication module LON (SC)

Communication module LON (SC)	2538243
SC communication module BACnet	
SC-communication module BACnet MS/TP (slave)	2538242
Communication module GSM (SC)	
Communication module GSM (SC)	2542216
Pump signalling module	
Signalling module pump 1-2	2533812
Signalling module pump 3-6	2533836
SC-HVAC signal board	
SC-HVAC signal board	2119646