



Similar to figure

Data sheet

Hydraulic data

Minimum efficiency index (MEI)	≥0.4
Maximum operating pressure PN	10 bar
Min. fluid temperature T_{min}	-20 °C
Max. fluid temperature T_{max}	120 °C
Max. ambient temperature T_{max}	40 °C

Motor data

Mains connection	3~400 V, 50 Hz
Number of poles	4
Voltage tolerance	±10 %
Motor efficiency class	IE2
Rated power P_2	0.37 kW
Rated current I_N	1.06 A
Rated speed n	1450 1/min
Power factor $\cos \varphi_{100}$	0.71
Motor efficiency 50% $\eta_M 50\%$	71.7 %
Motor efficiency 75% $\eta_M 75\%$	76.1 %
Motor efficiency 100% $\eta_M 100\%$	76.1 %
Motor winding up to 3 kW	-
Motor winding from 4 kW	-
Insulation class	F
Protection class motor	IP55
Integrated full motor protection	-

Materials

Pump housing	Grey cast iron
Impeller	PPE/PS-GF30
Shaft	Stainless steel
Mechanical seal	AQ1EGG
Lantern	Grey cast iron

Installation dimensions

Pipe connection on the suction side DN_s	DN 40
Pipe connection on the discharge side DN_d	DN 40
Port-to-port length L_0	320 mm

Pump curves

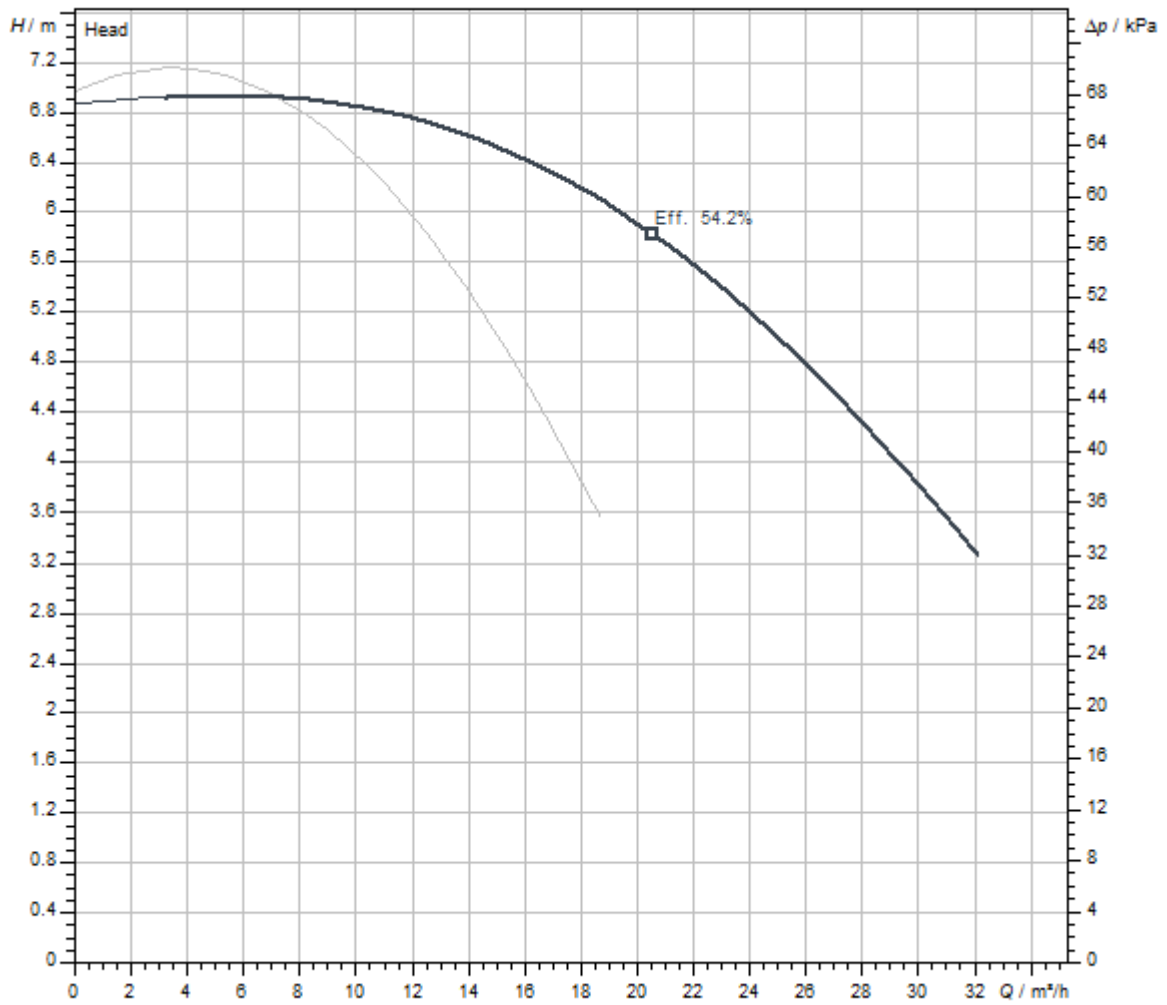

Fluid media	Water 100 %
Fluid temperature T	20.00 °C
speed at duty point $n_{hydr. @ OP}$	1,446 1/min
Impeller diameter $d_{imp.}$	148 mm

Dimensions and dimensions drawings

VeroTwin-DPL 40/160-0,37/4

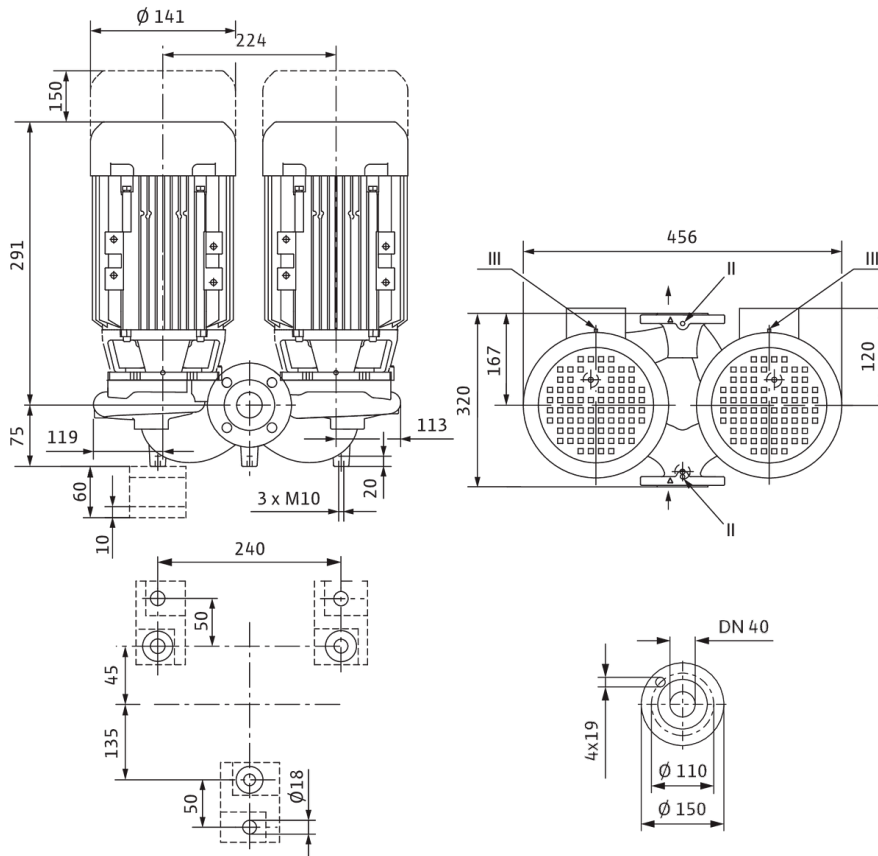

Wiring diagram

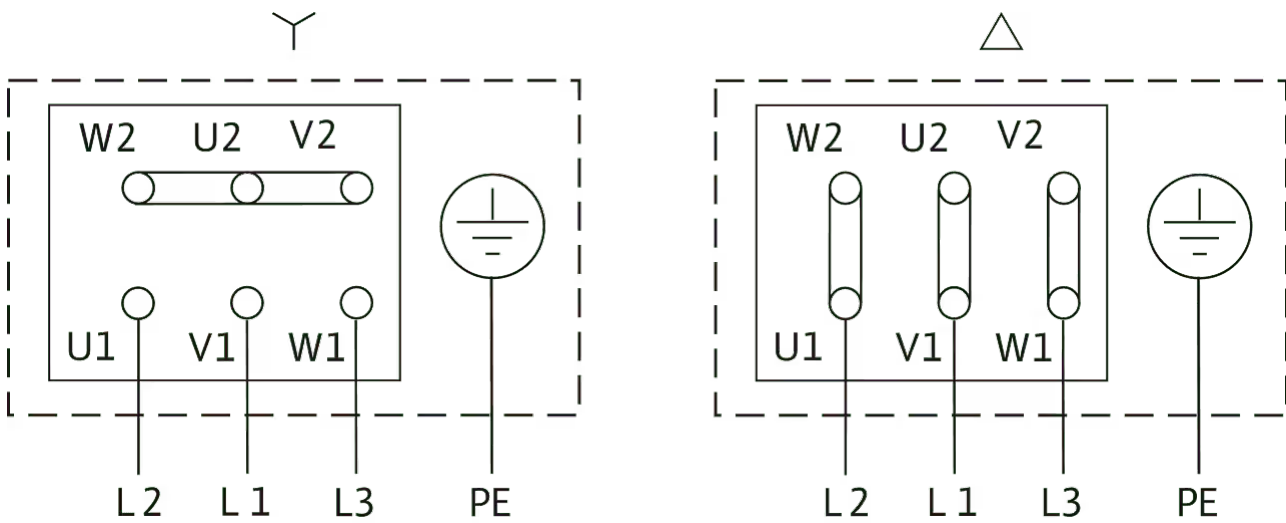

Δ: Connection diagram delta connection

Y: Connection diagram star connection

Motor protection switch required on-site. Check the direction of rotation! To change the direction of rotation, exchange any two phases.

$P_2 \leq 3$ kW 3~400 V Y

3~230 V Δ

$P_2 \geq 4$ kW 3~690 V Y

3~400 V Δ

After removing the bridges, Y-Δ start is possible.

Tender text

In-line twin-head pump with two single-stage glanded centrifugal pumps in the same housing with switchover valve in the pressure port. Pump with compact in-line design with directly flanged three-phase current motor and one-piece shafts or with lanterns and standard motors (version N) rigidly connected by couplings.

The DPL series is suitable for pipe installation or installation on a base. Mounting brackets are available as accessories. With force-flushed circulation,

bidirectional bellows mechanical seals and cavitation-reducing plastic impeller.

Flanges with pressure measuring connections R 1/8. The pump housing and lantern are cathophoretic-coated.

The motor terminal box can be made of metal or plastic. If a metal terminal box is absolutely necessary, please order the appropriate special variant.

Operating Data

Min. fluid temperature T_{\min}	-20 °C
Max. fluid temperature T_{\max}	120 °C
Min. ambient temperature T_{\min}	-15 °C
Max. ambient temperature T_{\max}	40 °C
Maximum operating pressure PN	10 bar
Minimum efficiency index (MEI)	≥ 0.4

Motor data

Motor efficiency class	IE2
Mains connection	3~400 V, 50 Hz
Voltage tolerance	± 10 %
Rated power P_2	370 W
Rated speed n	1450 1/min
Rated current I_N	1.06 A
Power factor $\cos \varphi_{100}$	0.71
Motor efficiency 50% $\eta_M 50\%$	71.7 %
Motor efficiency 75% $\eta_M 75\%$	76.1 %
Motor efficiency 100% $\eta_M 100\%$	76.1 %
Insulation class	F
Protection class	IP55

Materials

Pump housing	Grey cast iron
Impeller	PPE/PS-GF30
Shaft	Stainless steel
Shaft seal	AQ1EGG
Lantern	Grey cast iron

Installation dimensions

Pipe connection on the suction side DN_s	DN 40
Pipe connection on the discharge side DN_d	DN 40
Port-to-port length L_0	320 mm

Ordering information

Brand	Wilo
Product description	VeroTwin-DPL 40/160-0,37/4
Net weight, approx. m	43.9 kg
Article number	2089621 

Installation type

Continuous, infinitely variable control, differential pressure-sensitive SC-HVAC system

SC/SC-FC-HVAC system

SC-FC-HVAC system 1x1,6A-FC-WM (direct starting)	2545426
SC-FC-HVAC system 2x1,6A-FC-WM (direct starting)	2545427
SC-FC-HVAC system 3x1,6A-FC-WM (direct starting)	2545428
SC-FC-HVAC system 4x1,6A-FC-WM (direct starting)	2545429
SC-HVAC system 1x1,6A-WM (direct starting)	2545310
SC-HVAC system 2x1,6A-WM (direct starting)	2545311
SC-HVAC system 3x1,6A-WM (direct starting)	2545312
SC-HVAC system 4x1,6A-WM (direct starting)	2545313

Antenna GSM/GPRS

D-network dual-band antenna with 3 m cable	2533862
D-network tri-band antenna 10 m cable	2533863
D-network tri-band antenna 15 m cable	2533864

Outdoor temperature sensor Pt 100

Outdoor temperature sensor Pt 100	2533772
-----------------------------------	---------

DDG impulse selector

DDG impulse selector	2533770
----------------------	---------

Communication module LON (SC)

Communication module LON (SC)	2538243
-------------------------------	---------

SC communication module BACnet

SC-communication module BACnet MS/TP (slave)	2538242
--	---------

Communication module GSM (SC)

Communication module GSM (SC)	2542216
-------------------------------	---------

Pump signalling module

Signalling module pump 1-2	2533812
Signalling module pump 3-6	2533836

SC-HVAC signal board

SC-HVAC signal board	2119646
----------------------	---------

DDG (4-20mA)

Wilo-DDG 10 Signal Trans.(4-20mA)2G VP.	2136454
Wilo-DDG 100 Signal Trans.(4-20mA)	2211740
Wilo-DDG 20 Signal Trans.(4-20mA)2G VP.	2136456
Wilo-DDG 40 Signal Trans.(4-20mA)2G VP.	2136458
Wilo-DDG 60 Signal Trans.(4-20mA)2G VP.	2136460

PTC thermistor tripping unit

PTC thermistor tripping unit	509275993
------------------------------	-----------

Continuous, infinitely variable control, temperature-dependent SC-HVAC system

SC/SC-FC-HVAC system

SC-FC-HVAC system 1x1,6A-FC-WM (direct starting)	2545426
SC-FC-HVAC system 2x1,6A-FC-WM (direct starting)	2545427
SC-FC-HVAC system 3x1,6A-FC-WM (direct starting)	2545428
SC-FC-HVAC system 4x1,6A-FC-WM (direct starting)	2545429
SC-HVAC system 1x1,6A-WM (direct starting)	2545310
SC-HVAC system 2x1,6A-WM (direct starting)	2545311
SC-HVAC system 3x1,6A-WM (direct starting)	2545312
SC-HVAC system 4x1,6A-WM (direct starting)	2545313

Antenna GSM/GPRS

D-network dual-band antenna with 3 m cable	2533862
D-network tri-band antenna 10 m cable	2533863
D-network tri-band antenna 15 m cable	2533864

Outdoor temperature sensor Pt 100

Outdoor temperature sensor Pt 100	2533772
-----------------------------------	---------

Communication module LON (SC)

Communication module LON (SC)	2538243
-------------------------------	---------

SC communication module BACnet

SC-communication module BACnet MS/TP (slave)	2538242
--	---------

Communication module GSM (SC)

Communication module GSM (SC)	2542216
-------------------------------	---------

Pump signalling module

Signalling module pump 1-2	2533812
Signalling module pump 3-6	2533836

SC-HVAC signal board

SC-HVAC signal board

2119646

PTC thermistor tripping unit

PTC thermistor tripping unit

509275993