



Data sheet

Product data

Product description	HELIX V3603-4/16/E/S/400-50-FF240
---------------------	-----------------------------------

Hydraulic data

Minimum efficiency index (MEI)	≥0.7
Maximum inlet pressure p_{inl}	10 bar
Maximum operating pressure PN	16 bar
Discharge port	DN 65
Min. fluid temperature T_{min}	-20 °C
Max. fluid temperature T_{max}	120 °C
Min. ambient temperature T_{min}	-15 °C
Max. ambient temperature T_{max}	50 °C

Motor data

Mains connection	3~400 V, 50 Hz
Voltage tolerance	±10 %
Rated power P_2	9 kW
Motor efficiency class	IE3
Rated current I_N	16.7 A
Rated speed n	2900 1/min
Power factor $\cos \varphi_{100}$	0.87
Activation type	Direct/Star-Delta
Motor efficiency 50% $\eta_M 50\%$	90.4 %
Motor efficiency 75% $\eta_M 75\%$	91 %
Motor efficiency 100% $\eta_M 100\%$	90.6 %
Insulation class	F
Protection class motor	IP55

Materials

Pump housing	Grey cast iron
Impeller	Stainless steel
Shaft	Stainless steel
Mechanical seal	BQ1EGG
Gasket material	EPDM

Installation dimensions

Pipe connection on the suction side DN_s	DN 65
Pipe connection on the discharge side DN_d	DN 65

Pump curves

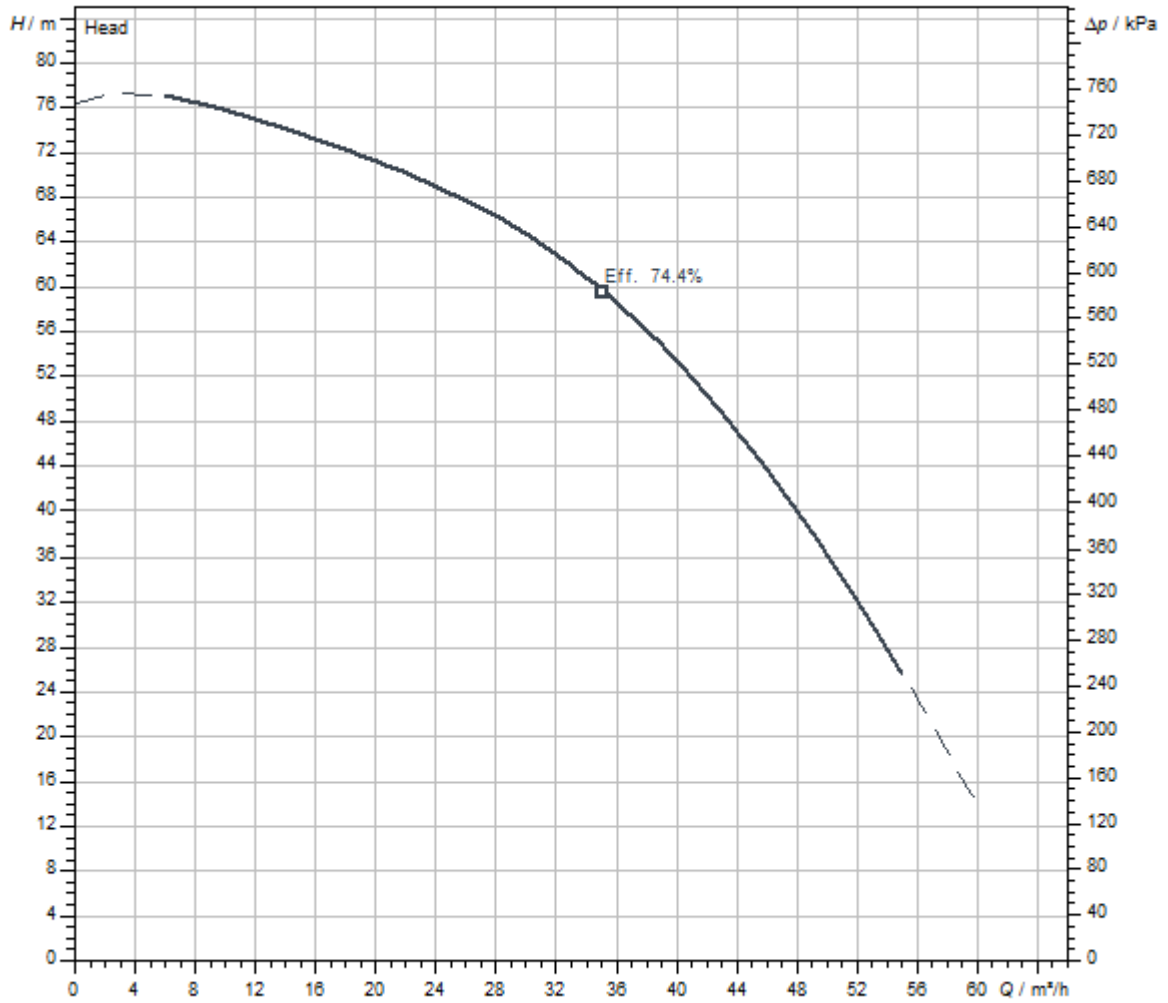

Fluid media	Water 100 %
Fluid temperature <i>T</i>	20.00 °C
speed at duty point <i>n hydr. @ OP</i>	2,979 1/min

Dimensions and dimensions drawings

Helix V 36

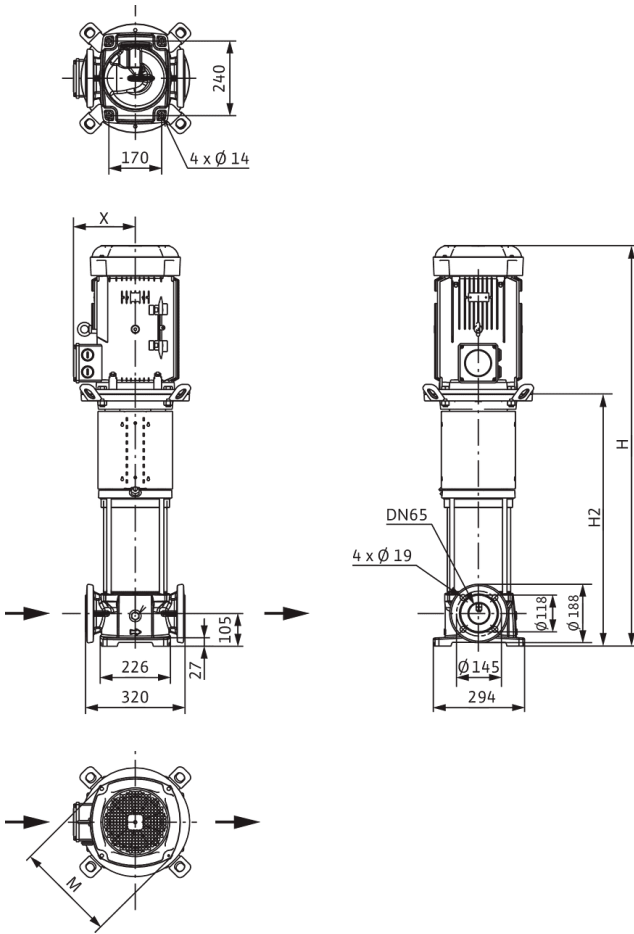

Dimensions <i>H</i>	973 mm
Dimensions <i>H1</i>	187 mm
Dimensions <i>L1</i>	160 mm
Dimensions <i>X</i>	182 mm
Dimensions $\varnothing g$	279 mm
Pipe connection on the suction side <i>DN_s</i>	DN 65
Pipe connection on the discharge side <i>DN_d</i>	DN 65
Motor diameter <i>X</i>	182 mm

Wiring diagram

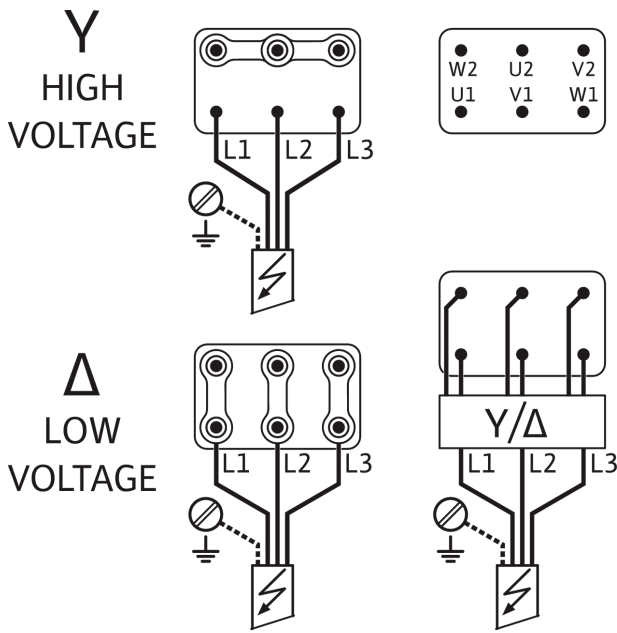

Ordering information

Product data

Brand	Wilo
Product description	HELIX V3603-4/16/E/S/400-50-FF240
Article number	4183405
EAN number	4048482356297
Colour	green/silver
Minimum order quantity	1
Date of sales availability	2014-03-01

Dimension, weight

Length with packaging	1200 mm
Length <i>L</i>	320 mm
Height with packaging	500 mm
Height <i>H</i>	973 mm
Width with packaging	400 mm
Width <i>W</i>	294 mm
Gross weight, approx. <i>m</i>	124 kg
Net weight, approx. <i>m</i>	110 kg

Packaging

Packaging type	One-way pallet
Packaging property	Transport packaging
Pieces per pallet	1
Number per layer	1

Tender text

Highly efficient high-pressure multistage centrifugal pump in vertical design with in-line connections.

The non self-priming high-pressure multistage centrifugal pump has a compact overall design and is particularly efficient and easy to maintain. The pump shaft and the motor shaft of the IEC standard motor are connected by means of a clamp coupling, while a separate lantern roller bearing ensures optimum admission of axial thrusts. Intermediate bearings in the hydraulics and corrosion-resistant shaft due to stainless steel sleeve ensure a long service life. Special, permanently attached lifting eyes enable easy pump installation.

The pump is suitable for water supply, water distribution and pressure boosting, industrial recirculation systems, process water and closed cooling circuits. It can also be used in fire extinguishing systems, washing systems as well as for irrigation.

Special features/product advantages

- > Efficiency-optimised, laser-welded 2D/3D hydraulics, flow and degassing optimised
- > Corrosion-resistant impellers, guide vanes and stage housings
- > Flow and NPSH-optimised pump housing
- > Maintenance-friendly design with particularly robust coupling guard
- > Drinking water approval for pumps with parts that come in contact with the fluid made of stainless steel (EPDM version)

Operating Data

Product data

Min. fluid temperature T_{min}	-20 °C
Max. fluid temperature T_{max}	120 °C
Max. ambient temperature T_{max}	50 °C
Maximum operating pressure PN	16 bar
Maximum inlet pressure p_{inl}	10 bar
Minimum efficiency index (MEI)	≥ 0.7

Scope of delivery

- > Wilo-Helix V high-pressure multistage centrifugal pump
- > Installation and operating instructions

Design notes

- > Motor protection for 3-phase motor is to be provided on request or onsite
- > Single-phase AC motor equipped with built-in thermal motor protection and capacitor
- > In its standard position, the terminal box is aligned with the suction flange, but this can be changed if necessary
- > The Wilo-Helix V is equipped with a user-friendly mechanical seal in a cartridge design and standard gasket for easy maintenance
- > The spacer coupling (from ≥ 7.5 kW) allows the mechanical seal to be replaced without removing the motor
- > The flexible lantern design, which is available in two alignments, enables direct access to the mechanical seal
- > For pump versions PN16, PN25 and $P_{max} = 30$ bar, round counter flanges in cast iron or stainless steel, screws, nuts and gaskets are available as accessories
- > Bypass sets are available as accessories
- > The Wilo-Helix V(F) VdS certified version upon request

Motor data

Mains connection	3~400 V, 50 Hz
Voltage tolerance	± 10 %
Rated power P_2	9 kW
Motor efficiency class	IE3
Rated current I_N	16.7 A
Rated speed n	2900 1/min
Power factor $\cos \varphi_{100}$	0.87
Motor efficiency 50% $\eta_M 50\%$	90.4 %
Motor efficiency 75% $\eta_M 75\%$	91 %
Motor efficiency 100% $\eta_M 100\%$	90.6 %
Insulation class	F
Protection class	IP55

Materials

Pump housing	Grey cast iron
Impeller	Stainless steel
Shaft	Stainless steel
Shaft seal	BQ1EGG
Gasket material	EPDM

Installation dimensions

Pipe connection on the suction side <i>DN_s</i>	DN 65
Pipe connection on the discharge side <i>DN_d</i>	DN 65

Ordering information

Brand	Wilo
Product description	HELIX V3603-4/16/E/S/400-50-FF240
Net weight, approx. <i>m</i>	110 kg
Article number	4183405

Installation type

In inlet mode

Counter flange (stainless steel)

Stainless steel counter flange (round, 2 piece), PN 16 DN 65	4038592
--	---------

Counter flange (steel)

Steel counter flange (round, 2 piece), PN 16 DN 65	4038591
--	---------

Stainless steel compensator

Stainless steel compensator DN 65, PN 16	2514242
--	---------

Baseplate

Base plate	4157154
------------	---------

Level control with fault signal

Float switch WAO

Float switch WAO 65, 10 m cable	2006027
---------------------------------	---------

Float switch WAO 65, 20 m cable	2004429
---------------------------------	---------

Float switch WAO 65, 30 m cable	2004430
---------------------------------	---------

Float switch WAO 65, 5 m cable	503211595
--------------------------------	-----------

Level control without fault signal

Float switch WAO

Float switch WAO 65, 10 m cable	2006027
---------------------------------	---------

Float switch WAO 65, 20 m cable	2004429
---------------------------------	---------

Float switch WAO 65, 30 m cable	2004430
---------------------------------	---------

Float switch WAO 65, 5 m cable	503211595
--------------------------------	-----------

Pressure control with fault signal

Wilo-EFC

EFC11 3x380-480V 50/60Hz IP55	2193439
-------------------------------	---------

Sensor kit

Sensor kit	2501886
------------	---------

Mechanical accessories

Bypass line

Bypass line

Bypass line for Helix and Medana CV1-L series	4230276
---	---------

Pipe installation

Counter flange (stainless steel)

Stainless steel counter flange (round, 2 piece), PN 16 DN 65	4038592
--	---------

Counter flange (steel)

Steel counter flange (round, 2 piece), PN 16 DN 65	4038591
--	---------

Stainless steel compensator

Stainless steel compensator DN 65, PN 16	2514242
--	---------

Wall fixation/installation on a base

Baseplate

Base plate	4157154
------------	---------

Electrical accessories

Pump control

Wilo-EFC

EFC11 3x380-480V 50/60Hz IP55	2193439
-------------------------------	---------

Pump control/accessories

Low-water cut-out switchgear kit for domestic water systems

low-water cut-out switchgear kit WMS G 1¼	4204510
low-water cut-out switchgear kit WMS G2	4204512

Output filter EFC (150-500 m cable length)

24.2 A sin IP54 Wilo-EFC filter	6084564
24 A sin IP00 Wilo-EFC filter	6084579
24 A sin IP20 Wilo-EFC filter	6084905

Output filter EFC du/dt (up to 150m cable length)

40 A du/dt IP54 Wilo-EFC filter	6084544
40 A du/dt IP00 Wilo-EFC filter	6084548
40 A du/dt IP20 Wilo-EFC filter	6084553

Pressure control

Pressure sensor for systems

Pressure sensor, 0 - 6 bar	2550660
Pressure sensor, 0 - 10 bar	2550661
Pressure sensor, 0 - 16 bar	2550662
Pressure sensor, 0 - 25 bar	2550663
Pressure sensor, 0 - 40 bar	2550664

Sensor kit

Sensor kit	2501886
------------	---------

Level control

Float switch WA

Float switch WA65 with 5 m cable	503211390
Float switch WA65 with 10 m cable	503211893
Float switch WA65 with 20 m cable	2004431
Float switch WA65 with 30 m cable	2004432

Float switch WA KR1 S with 5 m cable	6082806
Float switch WA KR1 S with 10 m cable	6082807
Float switch WA65 (PSN-X) with 20 m cable	6088843
Float switch WA65 (PSN-X) with 10 m cable	6088844
Float switch WA65 (PSN-X) with 5 m cable	6088845

Float switch WAO

Float switch WAO 65, 5 m cable	503211595
Float switch WAO 65, 10 m cable	2006027
Float switch WAO 65, 20 m cable	2004429
Float switch WAO 65, 30 m cable	2004430

Motor protection

PTC thermistor tripping unit

PTC thermistor tripping unit	509275993
------------------------------	-----------

Surcharge for thermistor sensor (high-pressure centrifugal pumps)

Surcharge for thermistor sensor (high-pressure centrifugal pumps)	HDK_KLF
---	---------

Services

With Wilo as your partner, you can not only be sure of choosing high-quality product solutions, but also of benefiting from a comprehensive, worry-free package of well thought-out services. We collaborate to develop a service concept tailored to your individual needs; with our expertise and personal consultancy, we make sure that the operation of your systems is as energy-efficient, reliable and economical as possible. All the while our competent Wilo service technicians are ready to assist you with fast, reliable and on-time support.

Recommended services

Maintenance BASIC Booster Set 1-2 pumps	2160453
Maintenance COMFORT Booster Set 1-2 pumps	2160468
Maintenance PREMIUM Booster Set 1-2 pumps	2160483
Commissioning Booster Set 1-2 pumps	2216414

More suitable services

Service Package L Booster Set 1-2 pumps	2216420
Service Package M Booster Set 1-2 pumps	2216419
Service Package S Booster Set 1-2 pumps	2216418
Wilo-Live Assistant Service	2216415
Extended Warranty Booster Set 1-2 pumps	2216416
Supervision Booster Set 1-2 pumps	2216412
Installation Booster Set 1-2 pumps	2216413
System Optimisation Booster Set 1-2 pump	2216410
Energy Solutions Booster Set 1-2 pumps	2216411
Repair Booster Set 1-2 pumps	2216417