



Data sheet

Product data

Product description	HELIX V214-1/25/E/KS/400-50
---------------------	-----------------------------

Hydraulic data

Minimum efficiency index (MEI)	≥0.7
Maximum inlet pressure p_{inl}	10 bar
Maximum operating pressure PN	25 bar
Discharge port	DN 25
Min. fluid temperature T_{min}	-30 °C
Max. fluid temperature T_{max}	120 °C
Min. ambient temperature T_{min}	-15 °C
Max. ambient temperature T_{max}	50 °C

Motor data

Mains connection	3~400 V, 50 Hz
Voltage tolerance	±10 %
Rated power P_2	1.1 kW
Motor efficiency class	IE3
Rated current I_N	2.5 A
Rated speed n	2900 1/min
Power factor $\cos \varphi_{100}$	0.80
Activation type	Direct On Line (DOL)
Motor efficiency 50% $\eta_M 50\%$	78.7 %
Motor efficiency 75% $\eta_M 75\%$	82 %
Motor efficiency 100% $\eta_M 100\%$	82.7 %
Insulation class	F
Protection class motor	IP55

Materials

Pump housing	Stainless steel
Impeller	Stainless steel
Shaft	Stainless steel
Mechanical seal	BQ1EGG
Gasket material	EPDM

Installation dimensions

Pipe connection on the suction side DN_s	DN 25
Pipe connection on the discharge side DN_d	DN 25

Pump curves

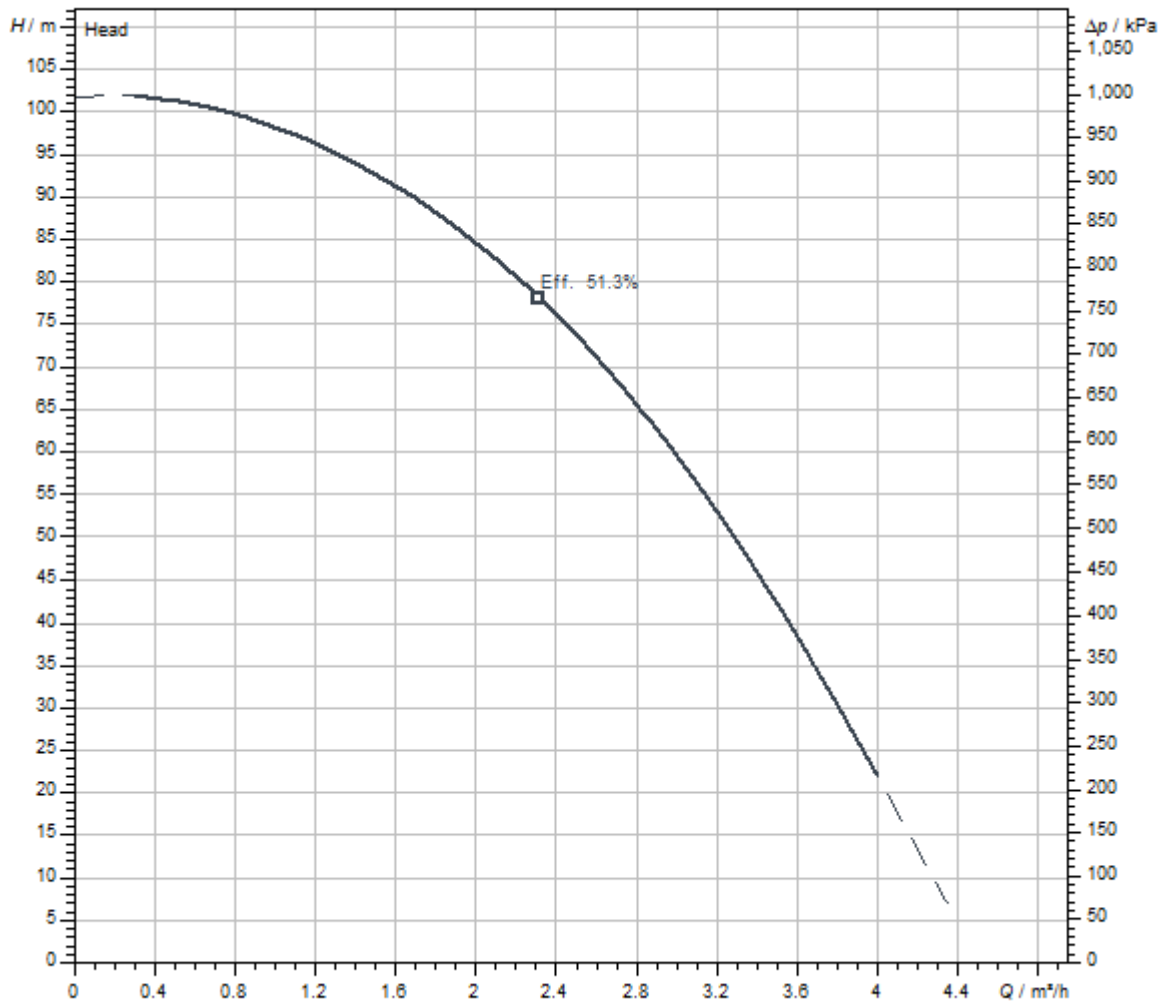

Fluid media	Water 100 %
Fluid temperature <i>T</i>	20.00 °C
speed at duty point <i>n hydr. @ OP</i>	2,943 1/min

Dimensions and dimensions drawings

Helix V 2/ V 4, PN 25

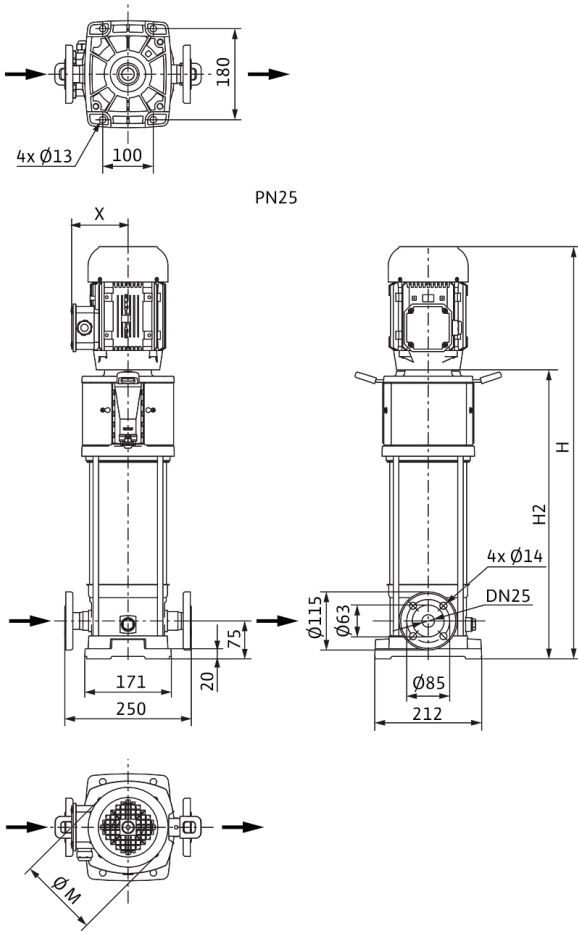

Dimensions <i>H</i>	924 mm
Dimensions <i>H1</i>	153 mm
Dimensions <i>L1</i>	125 mm
Dimensions <i>X</i>	115 mm
Dimensions $\varnothing g$	158 mm
Pipe connection on the suction side <i>DN_s</i>	DN 25
Pipe connection on the discharge side <i>DN_d</i>	DN 25
Motor diameter <i>X</i>	136 mm

Wiring diagram



Tender text

Highly efficient high-pressure multistage centrifugal pump in vertical design with in-line connections.

The non self-priming high-pressure multistage centrifugal pump has a compact overall design and is particularly efficient and easy to maintain. The pump shaft and the motor shaft of the IEC standard motor are connected by means of a clamp coupling.

A separate lantern roller bearing ensures optimum admission of axial thrusts. Intermediate bearings in the hydraulics and corrosion-resistant shaft due to stainless steel sleeve ensure a long service life. Special, permanently attached lifting eyes enable easy pump installation.

The pump is suitable for water supply, water distribution and pressure boosting, industrial recirculation systems, process water and closed cooling circuits. It can also be used in fire extinguishing systems, washing systems as well as for irrigation.

Special features/product advantages

- > Efficiency-optimised, laser-welded 2D/3D hydraulics, flow and degassing optimised
- > Corrosion-resistant impellers, guide vanes and stage housings
- > Flow and NPSH-optimised pump housing
- > Maintenance-friendly design with particularly robust coupling guard
- > Drinking water approval for pumps with parts that come in contact with the fluid made of stainless steel (EPDM version)

Scope of delivery

- > Wilo-Helix V high-pressure multistage centrifugal pump
- > Installation and operating instructions
- > PN16 version with oval flanges: Stainless steel counter flanges with the corresponding screws, nuts and gaskets

Design notes

- > Motor protection for 3-phase motor is to be provided on request or onsite
- > Single-phase AC motor equipped with built-in thermal motor protection and capacitor
- > In its standard position, the terminal box is aligned with the suction flange, but this can be changed if necessary
- > The Wilo-Helix V is equipped with a user-friendly mechanical seal in a cartridge design and standard gasket for easy maintenance
- > The spacer coupling (from ≥ 7.5 kW) allows the mechanical seal to be replaced without removing the motor
- > The flexible lantern design, which is available in two alignments, enables direct access to the mechanical seal
- > For pump versions PN16, PN25 and $P_{max} = 30$ bar, round counter flanges in cast iron or stainless steel, screws, nuts and gaskets are available as accessories
- > Bypass sets are available as accessories
- > The Wilo-Helix V(F) VdS certified version upon request

Operating Data

Product data

Min. fluid temperature T_{min}	-30 °C
Max. fluid temperature T_{max}	120 °C
Max. ambient temperature T_{max}	50 °C
Maximum operating pressure PN	25 bar
Maximum inlet pressure p_{inl}	10 bar
Minimum efficiency index (MEI)	≥ 0.7

Motor data

Mains connection	3~400 V, 50 Hz
Voltage tolerance	±10 %
Rated power P_2	1.1 kW
Motor efficiency class	IE3
Rated current I_N	2.5 A
Rated speed n	2900 1/min
Power factor $\cos \varphi_{100}$	0.80
Motor efficiency 50% $\eta_M 50\%$	78.7 %
Motor efficiency 75% $\eta_M 75\%$	82 %
Motor efficiency 100% $\eta_M 100\%$	82.7 %
Insulation class	F
Protection class	IP55

Materials

Pump housing	Stainless steel
Impeller	Stainless steel
Shaft	Stainless steel
Shaft seal	BQ1EGG
Gasket material	EPDM

Installation dimensions

Pipe connection on the suction side DN_s	DN 25
Pipe connection on the discharge side DN_d	DN 25

Ordering information

Brand	Wilo
Product description	HELIX V214-1/25/E/KS/400-50
Net weight, approx. m	39 kg
Article number	4161722

Installation type

In inlet mode

Counter flange (stainless steel)

Stainless steel counter flange (round, 2 piece), PN 25/PN 40 DN 25	4016165
--	---------

Counter flange (steel)

Steel counter flange (round, 2 piece), PN 25/PN 40 DN 25	4016162
--	---------

Baseplate

Base plate	4157154
------------	---------

Level control with fault signal

Float switch WAO

Float switch WAO 65, 10 m cable	2006027
Float switch WAO 65, 20 m cable	2004429
Float switch WAO 65, 30 m cable	2004430
Float switch WAO 65, 5 m cable	503211595

Level control without fault signal

Float switch WAO

Float switch WAO 65, 10 m cable	2006027
Float switch WAO 65, 20 m cable	2004429
Float switch WAO 65, 30 m cable	2004430
Float switch WAO 65, 5 m cable	503211595

Pressure control with fault signal

Wilo-EFC

EFC1.1 3x380-480V 50/60Hz IP55	2193432
--------------------------------	---------

Sensor kit

Sensor kit	2501886
------------	---------