



## Data sheet

### Product data

Product description	HELIX V412-1/25/E/KS/400-50
---------------------	-----------------------------

### Hydraulic data

Minimum efficiency index (MEI)	≥0.7
Maximum inlet pressure $p_{inl}$	10 bar
Maximum operating pressure $PN$	25 bar
Discharge port	DN 25
Min. fluid temperature $T_{min}$	-30 °C
Max. fluid temperature $T_{max}$	120 °C
Min. ambient temperature $T_{min}$	-15 °C
Max. ambient temperature $T_{max}$	50 °C

### Motor data

Mains connection	3~400 V, 50 Hz
Voltage tolerance	±10 %
Rated power $P_2$	1.5 kW
Motor efficiency class	IE3
Rated current $I_N$	3 A
Rated speed $n$	2900 1/min
Power factor $\cos \varphi_{100}$	0.85
Activation type	Direct On Line (DOL)
Motor efficiency 50% $\eta_M 50\%$	80.9 %
Motor efficiency 75% $\eta_M 75\%$	83.8 %
Motor efficiency 100% $\eta_M 100\%$	84.2 %
Insulation class	F
Protection class motor	IP55

### Materials

Pump housing	Stainless steel
Impeller	Stainless steel
Shaft	Stainless steel
Mechanical seal	BQ1EGG
Gasket material	EPDM

### Installation dimensions

Pipe connection on the suction side $DN_s$	DN 25
Pipe connection on the discharge side $DN_d$	DN 25

Pump curves

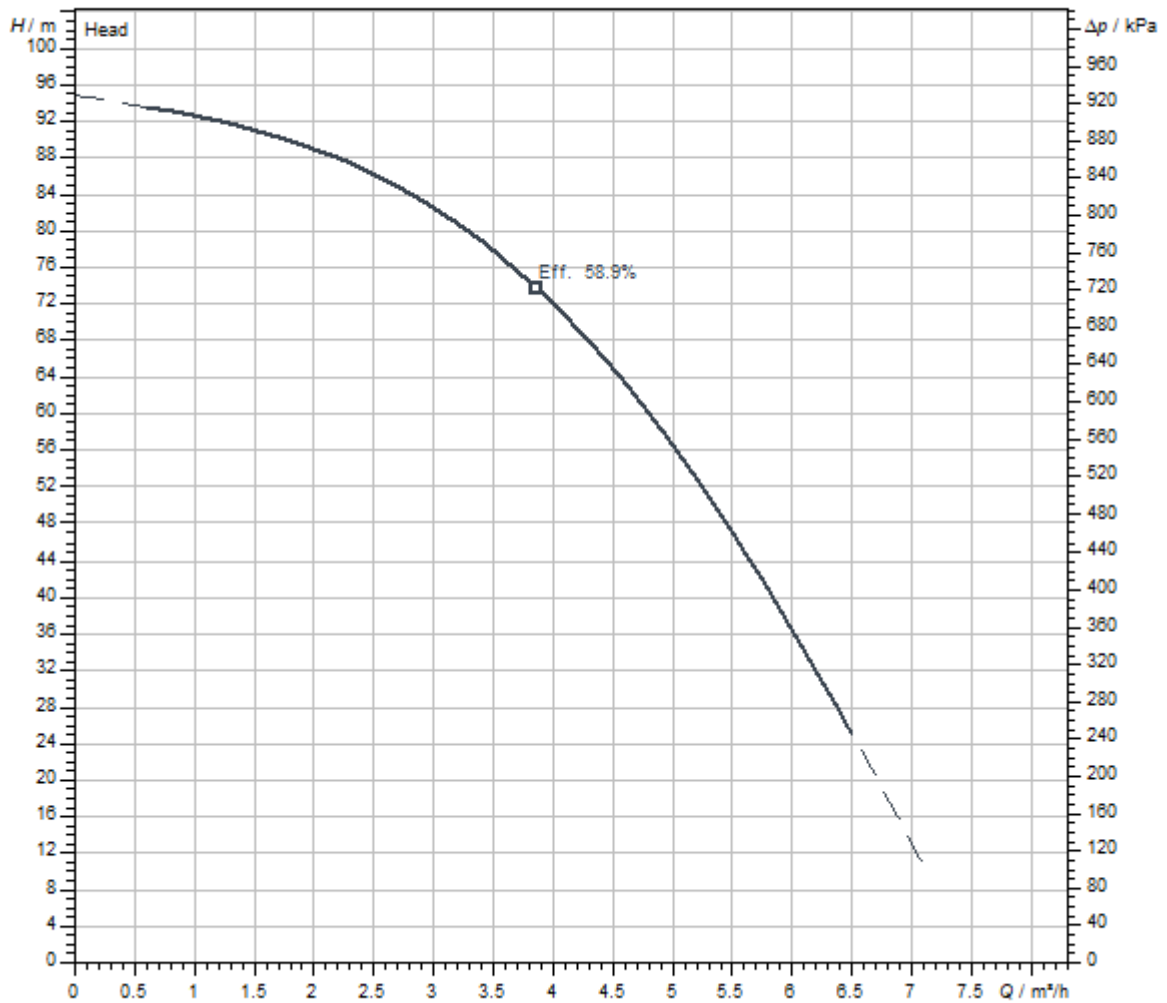

Fluid media	Water 100 %
Fluid temperature <i>T</i>	20.00 °C
speed at duty point <i>n hydr. @ OP</i>	2,956 1/min

Dimensions and dimensions drawings

Helix V 2/ V 4, PN 25

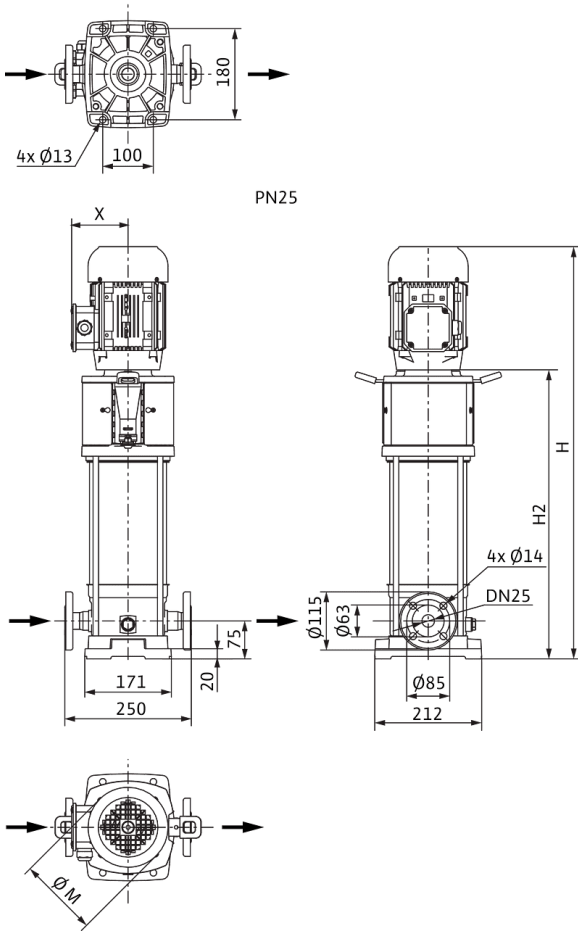

Dimensions <i>H</i>	950 mm
Dimensions <i>H1</i>	153 mm
Dimensions <i>L1</i>	125 mm
Dimensions <i>X</i>	132 mm
Dimensions $\varnothing g$	193 mm
Pipe connection on the suction side <i>DN<sub>s</sub></i>	DN 25
Pipe connection on the discharge side <i>DN<sub>d</sub></i>	DN 25
Motor diameter <i>X</i>	132 mm

Wiring diagram

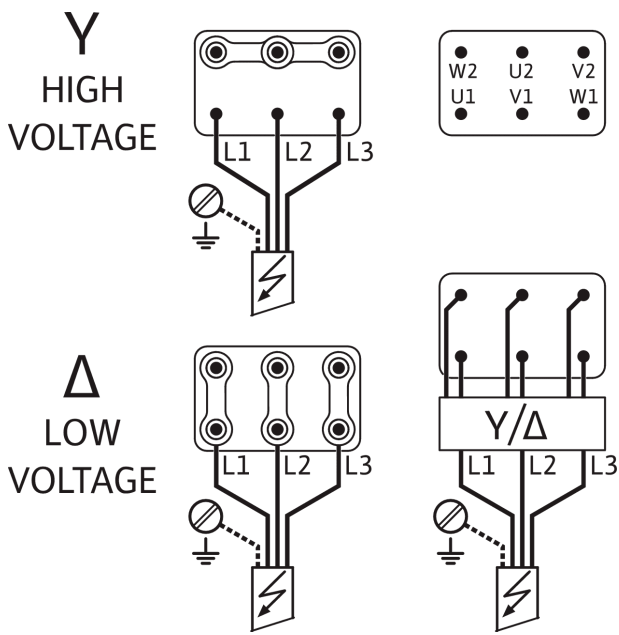

**Tender text**

Highly efficient high-pressure multistage centrifugal pump in vertical design with in-line connections.

The non self-priming high-pressure multistage centrifugal pump has a compact overall design and is particularly efficient and easy to maintain. The pump shaft and the motor shaft of the IEC standard motor are connected by means of a clamp coupling.

A separate lantern roller bearing ensures optimum admission of axial thrusts. Intermediate bearings in the hydraulics and corrosion-resistant shaft due to stainless steel sleeve ensure a long service life. Special, permanently attached lifting eyes enable easy pump installation.

The pump is suitable for water supply, water distribution and pressure boosting, industrial recirculation systems, process water and closed cooling circuits. It can also be used in fire extinguishing systems, washing systems as well as for irrigation.

**Special features/product advantages**

- > Efficiency-optimised, laser-welded 2D/3D hydraulics, flow and degassing optimised
- > Corrosion-resistant impellers, guide vanes and stage housings
- > Flow and NPSH-optimised pump housing
- > Maintenance-friendly design with particularly robust coupling guard
- > Drinking water approval for pumps with parts that come in contact with the fluid made of stainless steel (EPDM version)

**Scope of delivery**

- > Wilo-Helix V high-pressure multistage centrifugal pump
- > Installation and operating instructions
- > PN16 version with oval flanges: Stainless steel counter flanges with the corresponding screws, nuts and gaskets

**Design notes**

- > Motor protection for 3-phase motor is to be provided on request or onsite
- > Single-phase AC motor equipped with built-in thermal motor protection and capacitor
- > In its standard position, the terminal box is aligned with the suction flange, but this can be changed if necessary
- > The Wilo-Helix V is equipped with a user-friendly mechanical seal in a cartridge design and standard gasket for easy maintenance
- > The spacer coupling (from  $\geq 7.5$  kW) allows the mechanical seal to be replaced without removing the motor
- > The flexible lantern design, which is available in two alignments, enables direct access to the mechanical seal
- > For pump versions PN16, PN25 and  $P_{max} = 30$  bar, round counter flanges in cast iron or stainless steel, screws, nuts and gaskets are available as accessories
- > Bypass sets are available as accessories
- > The Wilo-Helix V(F) VdS certified version upon request

**Operating Data**

**Product data**

Min. fluid temperature $T_{min}$	-30 °C
Max. fluid temperature $T_{max}$	120 °C
Max. ambient temperature $T_{max}$	50 °C
Maximum operating pressure $PN$	25 bar
Maximum inlet pressure $p_{inl}$	10 bar
Minimum efficiency index (MEI)	$\geq 0.7$

**Motor data**

Mains connection	3~400 V, 50 Hz
Voltage tolerance	±10 %
Rated power $P_2$	1.5 kW
Motor efficiency class	IE3
Rated current $I_N$	3 A
Rated speed $n$	2900 1/min
Power factor $\cos \varphi_{100}$	0.85
Motor efficiency 50% $\eta_M 50\%$	80.9 %
Motor efficiency 75% $\eta_M 75\%$	83.8 %
Motor efficiency 100% $\eta_M 100\%$	84.2 %
Insulation class	F
Protection class	IP55

**Materials**

Pump housing	Stainless steel
Impeller	Stainless steel
Shaft	Stainless steel
Shaft seal	BQ1EGG
Gasket material	EPDM

**Installation dimensions**

Pipe connection on the suction side $DN_s$	DN 25
Pipe connection on the discharge side $DN_d$	DN 25

**Ordering information**

Brand	Wilo
Product description	HELIX V412-1/25/E/KS/400-50
Net weight, approx. $m$	41 kg
Article number	<b>4160533</b>

## Installation type

### In inlet mode

#### Counter flange (stainless steel)

Stainless steel counter flange (round, 2 piece), PN 25/PN 40 DN 25	4016165
--	---------

#### Counter flange (steel)

Steel counter flange (round, 2 piece), PN 25/PN 40 DN 25	4016162
--	---------

#### Baseplate

Base plate	4157154
------------	---------

### Level control with fault signal

#### Float switch WAO

Float switch WAO 65, 10 m cable	2006027
Float switch WAO 65, 20 m cable	2004429
Float switch WAO 65, 30 m cable	2004430
Float switch WAO 65, 5 m cable	503211595

### Level control without fault signal

#### Float switch WAO

Float switch WAO 65, 10 m cable	2006027
Float switch WAO 65, 20 m cable	2004429
Float switch WAO 65, 30 m cable	2004430
Float switch WAO 65, 5 m cable	503211595

### Pressure control with fault signal

#### Wilo-EFC

EFC1.1 3x380-480V 50/60Hz IP55	2193432
EFC1.5 3x380-480V 50/60Hz IP55	2193433

#### Sensor kit

Sensor kit	2501886
------------	---------