



Data sheet

Hydraulic data

Minimum efficiency index (MEI)	≥0.7
Maximum operating pressure P_N	16 bar
Min. fluid temperature T_{min}	-20 °C
Max. fluid temperature T_{max}	140 °C
Min. ambient temperature T_{min}	0 °C
Max. ambient temperature T_{max}	50 °C

Drive

Mains connection	3~400 V, 50/60 Hz
Number of poles	4
Motor efficiency class	IE5
Power consumption $P_{1\ max}$	1600 W
Rated power P_2	1.5 kW
Max current I_{max}	2.6 A
Emitted interference	EN 61800-3
Interference resistance	EN 61800-3
Insulation class	F
Protection class motor	IP55
Motor protection	PTC integrated

Materials

Pump housing	Grey cast iron
Impeller	PPS-GF40
Shaft	Stainless steel
Shaft seal	AQ1EGG
Lantern	5.1301/EN-GJL-250 KTL-coated

Approved liquids (other liquids upon request)

Heating water (as per VDI 2035)	yes
Heat carrier oil	Special version at additional charge
Cooling and cold water circulation systems	yes
Water-glycol mixtures (at 20 – 40 vol. % glycol and fluid temperature ≤ 40 °C)	yes

Installation dimensions

Port-to-port length L_0	340 mm
Pipe connection on the suction side DN_s	DN 65
Pipe connection on the discharge side DN_d	DN 65

Pump curves

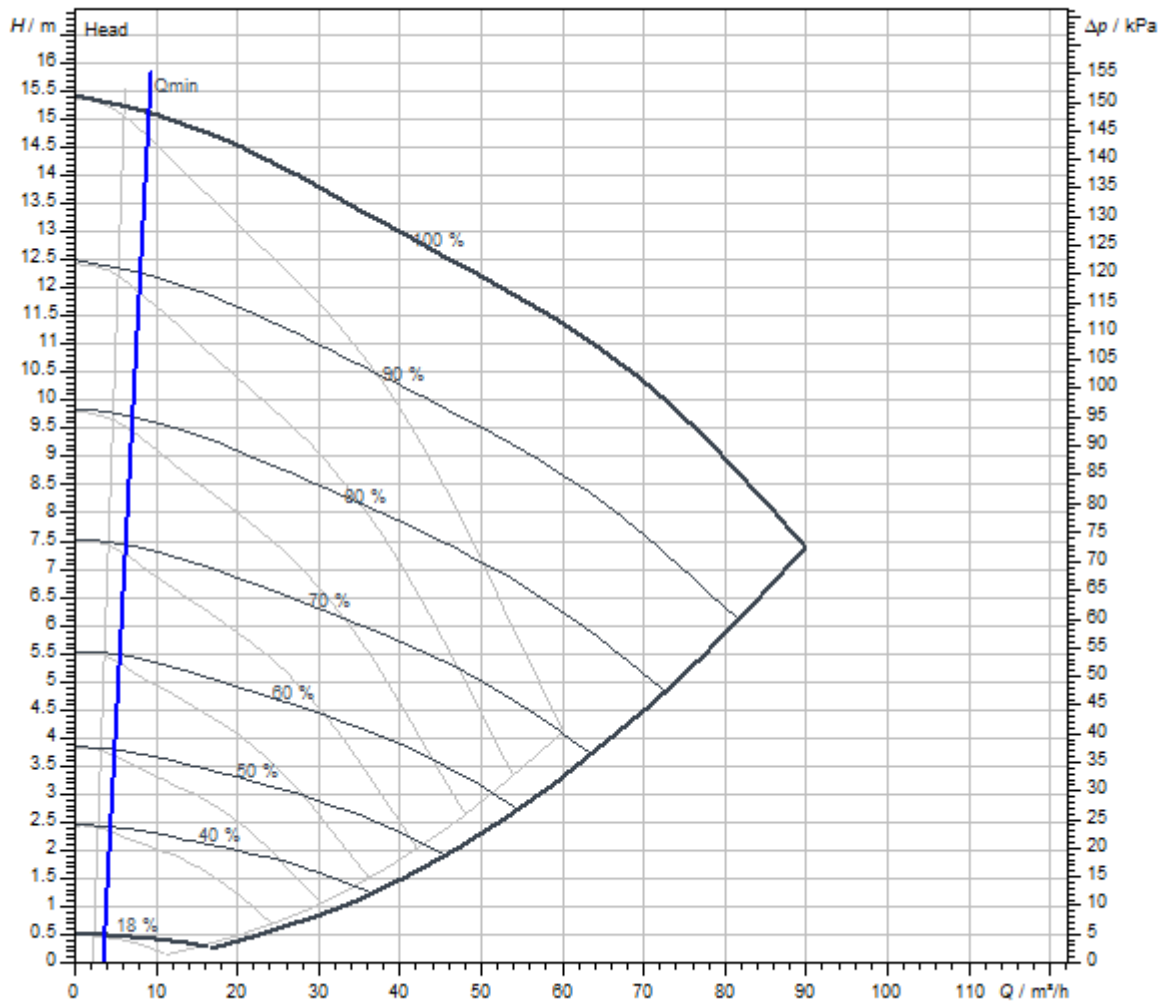

Fluid media	Water 100 %
Fluid temperature <i>T</i>	20.00 °C
speed at duty point <i>n hydr. @ OP</i>	2,925 1/min

Dimensions and dimensions drawings

Stratos GIGA2.0-D 65/1-15/1,5-R1

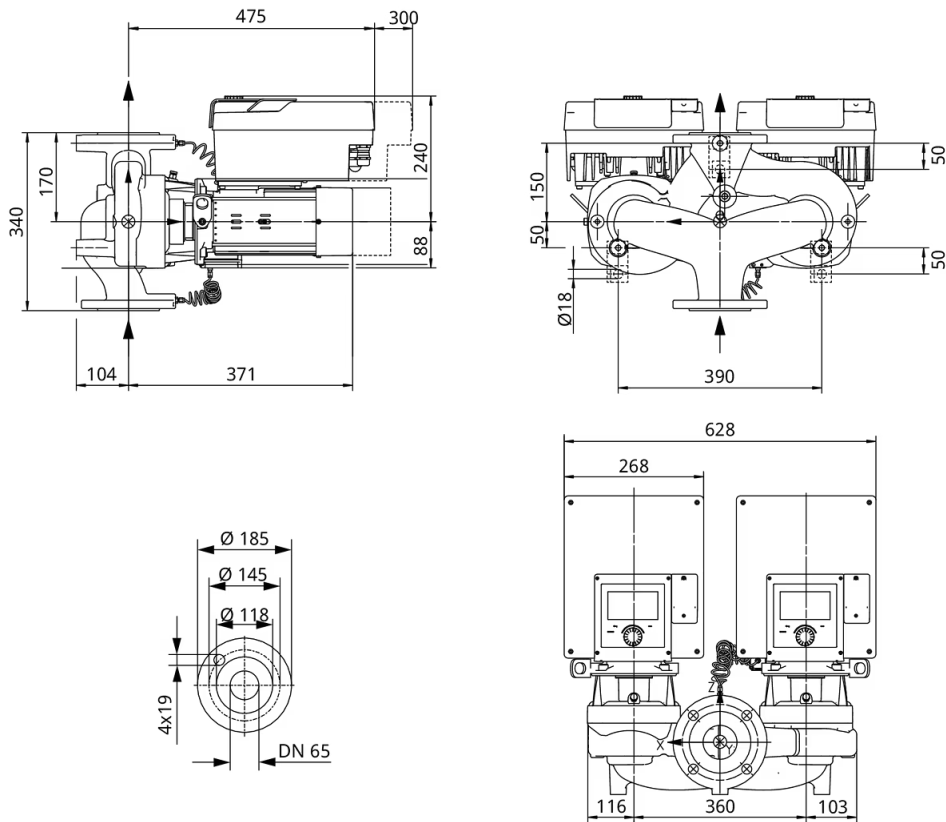

Wiring diagram

Wilo-Stratos GIGA2.0

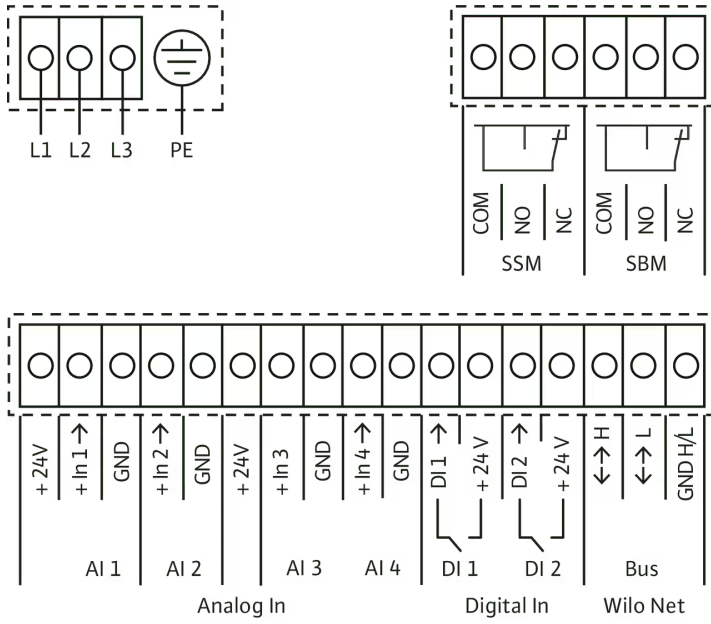

Bezeichnung

Tender text

High-efficiency in-line pump with EC motor of energy efficiency class IE5 in accordance with IEC 60034-30-2, hydraulics with minimum efficiency index $MEI \geq 0.7$ and electronic power adjustment in glanded pump construction. The pump is configured as a single-stage low-pressure centrifugal pump with flange connection and mechanical seal. The **Stratos GIGA2.0-D** has been predominantly designed for pumping heating water (acc. to VDI 2035), cold water and water-glycol mixtures without abrasive substances in heating, air-conditioning and cooling systems.

Design ...-R1:

- > Single-stage low-pressure centrifugal pump with one-piece shaft in monobloc design
- > Spiral housing in in-line design (suction and discharge ports with the same flanges in a line)
- > PN 16 flange – in accordance with EN 1092-2
- > Pressure measuring connections (R 1/8) for retrofitting of a differential pressure sensor (version ...-R1 without differential pressure sensor)
- > Pump housing and motor flange with cataphoretic coating as standard
- > Mechanical seal for pumping water up to $T_{max.} = +140\text{ °C}$. A glycol admixture of 20 % to +40 % by volume is permitted up to $T \leq +40\text{ °C}$. An alternative mechanical seal must be provided in water-glycol mixtures with glycol proportions > 40 % up to max. 50 % by volume and a fluid temperature of > +40 °C up to max. +120 °C or fluids other than water. When using water-glycol mixtures, the use of an S1 variant with a corresponding mechanical seal is generally recommended.
- > Connection voltages:
 - > 3~440 V $\pm 10\%$ 50/60 Hz; 3~400 V $\pm 10\%$ 50/60 Hz; 3~380 V -5 % +10 % 50/60 Hz
 - > Version M-: 1~220 V ... 240 V ($\pm 10\%$), 50/60 Hz
- > Compliance with electromagnetic compatibility without additional measures
 - > Interference emission for residential environment according to EN 61800-3:2018
 - > Interference immunity for industrial environments according to EN 61800-3:2018

Control modes:

- > Constant speed (**n-const.**)
- > Constant temperature (**T-const.**)
- > Constant differential temperature (**dT-const.**)
- > User-defined **PID** control
- > Only possible with differential pressure sensor:
 - > Permanent, automatic performance adjustment to system requirements without setpoint specification **Wilo Dynamic Adapt plus** (factory setting).
 - > Needs-based volume flow optimisation of the feeder pump through connectivity and communication between multiple secondary pumps (**Multi-Flow Adaptation**).
- > Constant volume flow (**Q-const.**)
- > Variable differential pressure (**dp-v**) with the option to set the nominal duty point Q and H
- > Constant differential pressure (**dp-c**)
- > Differential pressure control (dp-c) to a remote point in the pipe network (**index circuit evaluator**)

Functions:

- > Selection of the field of application in the **setting assistant**
- > **Operating modes of twin-head pump: Main/standby operation**
- > **Switchover** between **heating and cooling mode** (automatic, external or manual)
- > Ability to save and restore configured pump settings (**3 restoration points**)
- > **Fault and warning messages** shown in plain text with advice on resolving the issue
- > Integrated **full motor protection**
- > Only possible with differential pressure sensor:
 - > **Heat quantity measurement**
 - > **Cooling quantity measurement**
 - > Adjustable volume flow limiter using the Q-Limit function (**Q_{min.}** and **Q_{max.}**)
 - > Pump automatically deactivates when no flow is detected (**No-Flow Stop**)
 - > Efficiency-optimised **parallel operation** for dp-c and dp-v

Display in the "Home screen" of the graphic display:

- > Control mode currently set
- > Current setpoint
- > Current volume flow (only if a differential pressure sensor is connected)
- > Current fluid temperature (only if temperature sensor is connected)
- > Current power consumption
- > Cumulative electric consumption

Version:

- > **4** configurable **analogue inputs**: 0 – 10 V, 2–10 V, 0 – 20 mA, 4 – 20 mA and commercially available PT1000 (only on two analogue inputs); +24 V DC power supply
- > **2** configurable **digital inputs** (Ext. OFF, Ext. Min, Ext. Max, heating/cooling, manual override (uncoupled from building automation), operation lock (key lock and remote operation configuration protection))
- > **2** configurable **signal relays** for **run signals and fault messages**
- > **Slot for Wilo-CIF modules** with interfaces for building automation (BA) (optional accessories: CIF modules Modbus RTU, BACnet MS/TP, LON, PLR, CAN)
- > **Wilo Net** as a Wilo system bus for communication between Wilo products, e.g. Multi-Flow Adaptation; twin-head pump operation
- > **Automatic emergency operation** with definable pump speed for exceptional circumstances, e.g. bus communication or sensor value malfunction
- > **Rotatable, graphic colour display** (4.3 inches) with one button manual operation level
- > **Bluetooth interface** via Wilo-Smart Connect module BT
- > Use the Wilo-Assistant app to read and set operating data and –among other things– set up a commissioning protocol through the Bluetooth interface
- > Integrated **dual pump management** (twin-head pumps are prewired) when using 2 single pumps as twin-head pump unit (connection via Wilo Net)
- > **Cable break detection** when using an analogue signal (in connection with 2 – 10 V or 4 – 20 mA)
- > **Time stamp** for error/warnings and historical operating data
- > Continuous **operating data memory**
- > Standard **condensate drainage holes** in the motor housing (closed upon delivery)
- > **Air vent valve** on the lantern

Scope of delivery:

- > Pump
- > Wilo-Smart Connect Module BT
- > Threaded cable glands with sealing inserts
- > Installation and operating instructions and declaration of conformity

Accessories must be ordered separately:

3 mounting brackets with fixation material for installation on a base

- > Blind flanges for twin-head pump housing
- > Installation aid for mechanical seal (incl. mounting bolts)
- > For connection to building automation:
 - > CIF module PLR
 - > CIF module LON
 - > CIF module BACnet MS/TP
 - > Modbus RTU CIF module
 - > CIF module CANopen
 - > CIF module Ethernet Multi-protocol (Modbus TCP, BACnet/IP)
 - > Connection M12 RJ45 CIF Ethernet
- > Differential pressure sensor DPS 2 ... 10 V
- > Differential pressure sensor DPS 4 ... 20 mA
- > Temperature sensor PT1000 AA
- > Sensor sleeves for the installation of temperature sensors in the pipe

Operating Data

Min. fluid temperature T_{\min}	-20 °C
Max. fluid temperature T_{\max}	140 °C
Min. ambient temperature T_{\min}	0 °C
Max. ambient temperature T_{\max}	50 °C
Maximum operating pressure P_N	16 bar
Minimum efficiency index (MEI)	≥0.7

Drive

Mains connection	3~400 V, 50/60 Hz
Motor efficiency class	IE5
Power consumption $P_{1\max}$	1600 W
Rated power P_2	1.5 kW
Max current I_{\max}	2.6 A
Max. speed n_{\max}	2930 1/min
Emitted interference	EN 61800-3
Interference resistance	EN 61800-3
Insulation class	F
Protection class motor	IP55
Motor protection	PTC integrated

Materials

Pump housing	Grey cast iron
Impeller	PPS-GF40
Shaft	Stainless steel
Shaft seal	AQ1EGG
Lantern	5.1301/EN-GJL-250 KTL-coated

Installation dimensions

Pipe connection on the suction side DN_s	DN 65
Pipe connection on the discharge side DN_d	DN 65
Port-to-port length L_0	340 mm

Ordering information

Brand	Wilo
Product description	Stratos GIGA2.0-D 65/1-15/1,5-R1
Net weight, approx. m	86 kg
Article number	2205747 

Installation type

Continuous, infinitely variable control, differential pressure-sensitive CCe-HVAC system

CCe-HVAC system

CCe-HVAC system 1 x 0.75	2536658
CCe-HVAC system 2 x 0.75	2536659
CCe-HVAC system 3 x 0.75	2536660
CCe-HVAC system 4 x 0.75	2536661
CCe-HVAC system 5 x 0.75	2536662
CCe-HVAC system 6 x 0.75	2536663

Antenna GSM/GPRS

D-network dual-band antenna with 3 m cable	2533862
D-network tri-band antenna 10 m cable	2533863
D-network tri-band antenna 15 m cable	2533864

Outdoor temperature sensor Pt 100

Outdoor temperature sensor Pt 100	2533772
-----------------------------------	---------

DDG impulse selector

DDG impulse selector	2533770
----------------------	---------

BMS base module

BMS base module	2533800
-----------------	---------

CC communication module BACnet

CC-communication module BACnet IP (slave)	2537051
CC-communication module BACnet MS/TP (slave)	2537050

Communication module LON

Communication module LON	2533868
--------------------------	---------

Communication module ModBus

Communication module Modbus RTU	2533869
---------------------------------	---------

Communication module Profibus

Communication module Profibus DP	2533866
----------------------------------	---------

Communication module CC

CC communication module	2533850
-------------------------	---------

Communication module GSM

GSM module	2533861
------------	---------

Pump signalling module

Signalling module pump 1-2	2533812
----------------------------	---------

Signalling module pump 3-6	2533836
----------------------------	---------

Signal converter retrofit kit

Signal converter 0-10 V / 0-20 mA	2534992
-----------------------------------	---------

Connection cable control modules/signalling modules

Control modules connecting cable	2533790
----------------------------------	---------

Signalling modules connecting cable	2533890
-------------------------------------	---------

DDG transducer

DDG transducer	501771990
----------------	-----------

DDG power supply unit

DDG power supply unit	501865293
-----------------------	-----------

Extension kit differential pressure sensor for Y-piece application

Extension for DDG-kit	2166098
-----------------------	---------

Continuous, infinitely variable control, temperature-dependent CCe-HVAC system

CCe-HVAC system

CCe-HVAC system 1 x 0.75	2536658
--------------------------	---------

CCe-HVAC system 2 x 0.75	2536659
--------------------------	---------

CCe-HVAC system 3 x 0.75	2536660
--------------------------	---------

CCe-HVAC system 4 x 0.75	2536661
--------------------------	---------

CCe-HVAC system 5 x 0.75	2536662
--------------------------	---------

CCe-HVAC system 6 x 0.75	2536663
--------------------------	---------

Antenna GSM/GPRS

D-network dual-band antenna with 3 m cable	2533862
--	---------

D-network tri-band antenna 10 m cable	2533863
---------------------------------------	---------

D-network tri-band antenna 15 m cable	2533864
---------------------------------------	---------

Outdoor temperature sensor Pt 100

Outdoor temperature sensor Pt 100	2533772
-----------------------------------	---------

BMS base module

BMS base module	2533800
CC communication module BACnet	
CC-communication module BACnet IP (slave)	2537051
CC-communication module BACnet MS/TP (slave)	2537050
Communication module LON	
Communication module LON	2533868
Communication module ModBus	
Communication module Modbus RTU	2533869
Communication module Profibus	
Communication module Profibus DP	2533866
Communication module CC	
CC communication module	2533850
Communication module GSM	
GSM module	2533861
Pump signalling module	
Signalling module pump 1-2	2533812
Signalling module pump 3-6	2533836
Signal converter retrofit kit	
Signal converter 0-10 V / 0-20 mA	2534992
Temperature module	
Temperature module for systems with 1-3 pumps	2534991
Temperature module for systems with 4-6 pumps	2533771
Connection cable control modules/signalling modules	
Control modules connecting cable	2533790
Signalling modules connecting cable	2533890
Continuous, infinitely variable control, differential pressure-sensitive SCe-HVAC system	
SCe-HVAC system	
SCe-HVAC system 1x10A-WM	2545254
SCe-HVAC system 2x10A-WM	2545255
SCe-HVAC system 3x10A-WM	2545256

SCe-HVAC system 4x10A-WM	2545257
Antenna GSM/GPRS	
D-network dual-band antenna with 3 m cable	2533862
D-network tri-band antenna 10 m cable	2533863
D-network tri-band antenna 15 m cable	2533864
Outdoor temperature sensor Pt 100	
Outdoor temperature sensor Pt 100	2533772
DDG impulse selector	
DDG impulse selector	2533770
Communication module LON (SC)	
Communication module LON (SC)	2538243
SC communication module BACnet	
SC-communication module BACnet MS/TP (slave)	2538242
Communication module GSM (SC)	
Communication module GSM (SC)	2542216
Pump signalling module	
Signalling module pump 1-2	2533812
Signalling module pump 3-6	2533836
SC-HVAC signal board	
SC-HVAC signal board	2119646
DDG transducer	
DDG transducer	501771990
DDG power supply unit	
DDG power supply unit	501865293
Extension kit differential pressure sensor for Y-piece application	
Extension for DDG-kit	2166098