

Data sheet

Hydraulic data

Maximum inlet pressure p_{inl}	6 bar
Maximum operating pressure PN	10 bar
Discharge port	Rp 1
Min. fluid temperature T_{min}	-20 °C
Max. fluid temperature T_{max}	90 °C
Min. ambient temperature T_{min}	-15 °C
Max. ambient temperature T_{max}	50 °C

Motor data

Mains connection	1~230 V, 50/60 Hz
Rated power P_2	0.75 kW
Motor efficiency class	IE5
Rated current I_N	4.2 A
Activation type	Softstart
Motor efficiency 100% $\eta_M 100\%$	88.8 %
Insulation class	F
Protection class motor	IP55

Materials

Pump housing	Stainless steel
Impeller	Stainless steel
Shaft	Stainless steel
Mechanical seal	BQ1VGG
Gasket material	FKM

Installation dimensions

Pipe connection on the suction side DNs	Rp 1
Pipe connection on the discharge side DNd	Rp 1

Dimensions and dimensions drawings

MEDANA CH3-LE.403-2/V/1/10T

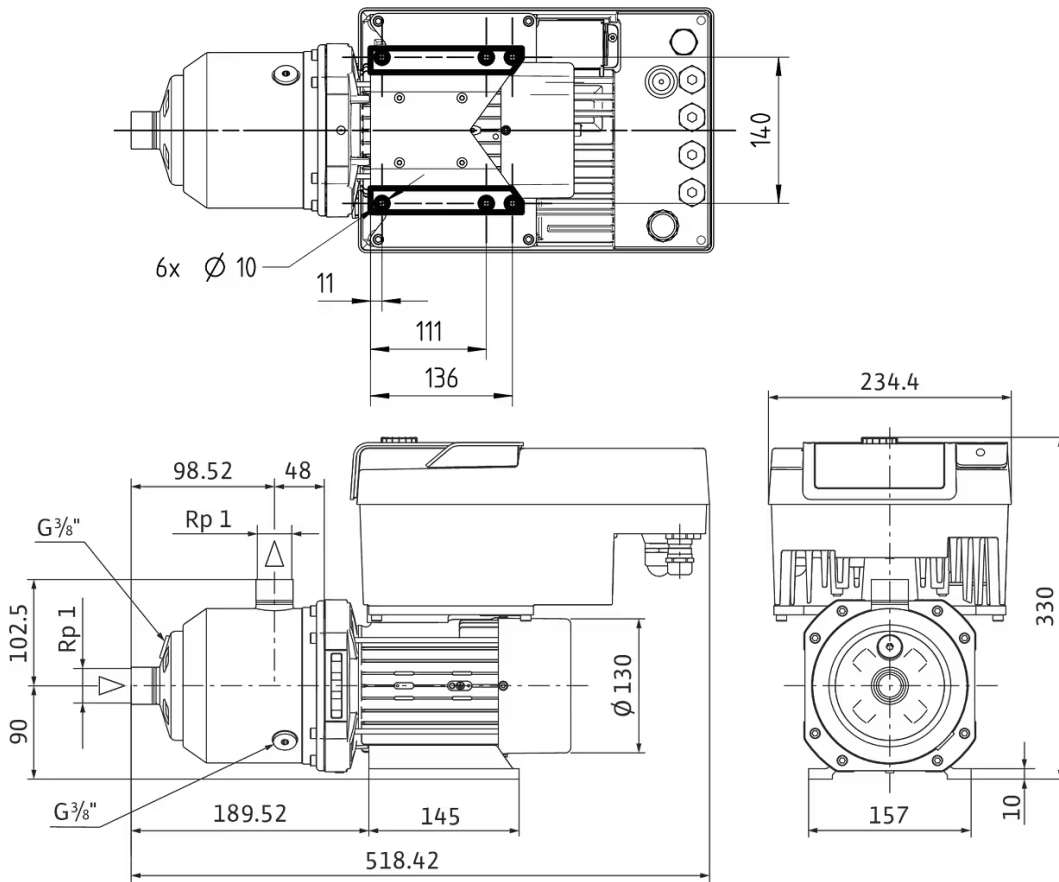

Wiring diagram

1~230V, 50/60 Hz

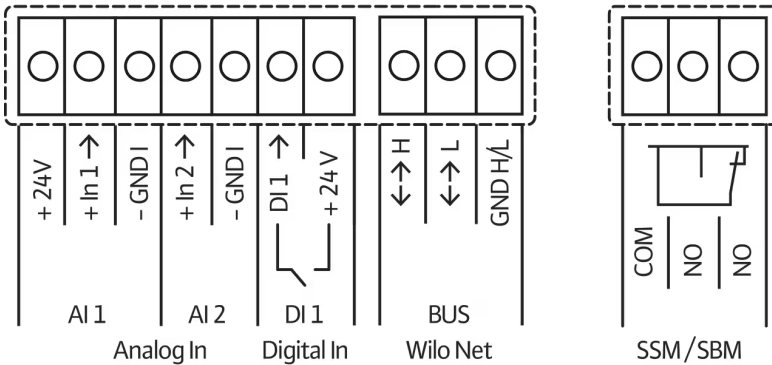
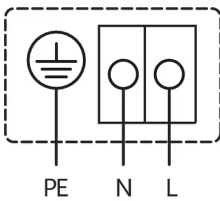

Ordering information

Product data

Brand	Wilo
Product description	MEDANA CH3-LE.403-2/V/1/10T
Article number	4250149 
EAN number	4062679209906
Colour	Green/black/silver
Minimum order quantity	1
Date of sales availability	2023-04-14

Packaging

Packaging type	Box
Packaging property	Sales packaging
Pieces per pallet	18
Number per layer	6

Dimension, weight

Length with packaging	785 mm
Length <i>L</i>	518 mm
Height with packaging	350 mm
Height <i>H</i>	330 mm
Width with packaging	385 mm
Width <i>W</i>	234 mm
Gross weight, approx. <i>m</i>	25.6 kg
Net weight, approx. <i>m</i>	21.6 kg

Tender text

Highly efficient, non-self-priming high-pressure multistage centrifugal pump in horizontal design, equipped with electronically controlled EC motor of energy efficiency class IE5 in accordance with IEC 60034-30-2.

The pump is suitable for water supply, water distribution and pressure boosting, industrial recirculation systems, process water, closed cooling circuits and heating. It can also be used in washing systems as well as for irrigation.

Control modes:

- > Constant speed n-c: manually with green button or via external signals
- > Constant pressure p-c, constant differential pressure Δp -c, variable pressure p-v, variable differential pressure Δp -v: pressure control with sensor, setpoint adjustment with green button or by means of external signals
- > PID control: other constant control variables (temperature, volume flow, pressure....) with sensor, setpoint adjustment with green button, by means of external signals

The electronic module provides various functions:

- > Max. pressure limit detection
- > Min. pressure limit detection
- > Lack of water detection by suction sensor
- > Zero-flow test (open loop)
- > No-Flow Stop (closed loop)
- > Dry-running detection
- > Volume flow calculation by using differential pressure sensor
- > Pump kick
- > Error and warning codes
- > Overload protection
- > Plug-in position for Wilo CIF modules PLR, LON, BACnet MS/TP, Modbus RTU, CANopen, Ethernet Multi-protocol (Modbus TCP, BACnet/IP) for connection to the building automation
- > Green LED indicates the pump status
- > Blue LED indicates that the pump is influenced externally via an interface

Analogue input:

- > IN (AI 1): Input sensor signal 4-20 mA, 0-10 V, 0-20 mA or 2-10 V
- > IN (AI 2): Input setpoint 0-20 mA, 0-10 V, 4-20 mA or 2-10 V

Digital input IN (DI 1):

- > Extern OFF
- > Lack of water detection by binary input

Dual pump management (2 x single pumps)

- > Main/standby operation

- > Pump cycling main/standby operation after 24 hours or automatic fault-actuated switchover
- > Wired connection via Wilo Net

Special features/product advantages

- > IE5 EC motor and integrated frequency converter in combination with Medana CH high efficiency hydraulics
- > 2" coloured LCD display, Wilo Green Button Technology and soft button with return function. The pump menu is clearly structured and enables a comfortable setting of the pump.
- > Analogue and digital interface as well as CIF module
- > Intelligent with various control modes, integrated dual pump management
- > Efficiency-optimised, laser-welded 2D/3D high-efficiency hydraulics (flow and degassing optimised)
- > Corrosion-resistant impellers, guide vanes and stage housings
- > Flow and degassing-optimised hydraulics
- > Flow and NPSH-optimised pump housing
- > Easy-maintenance design
- > Drinking water approval for pumps with parts that come in contact with the fluid made of stainless steel (EPDM version)

Scope of delivery

- > Medana CH3-LE multistage centrifugal pump
- > Installation and operating instructions

Design notes

- > Optional plug-in CIF-Modules PLR, LON, BACnet MS/TP, Modbus RTU, CANopen, Ethernet Multi-protocol (Modbus TCP, BACnet/IP) for connection to the building automation
- > Optional connection M12 RJ45 CIF Ethernet
- > Sensors are available as accessories: differential pressure kit 4 - 20mA and relative pressure kit 4 - 20mA

Operating Data

Product data

Maximum operating pressure P_N	10 bar
Min. fluid temperature T_{min}	-20 °C
Max. fluid temperature T_{max}	90 °C
Max. ambient temperature T_{max}	50 °C

Motor data

Mains connection	1~230 V, 50/60 Hz
Rated power P_2	0.75 kW
Rated current I_N	4.2 A
Insulation class	F
Protection class	IP55
Motor efficiency class	IE5

Materials

Pump housing	Stainless steel
Impeller	Stainless steel
Shaft	Stainless steel
Shaft seal	BQ1VGG
Gasket material	FKM

Installation dimensions

Pipe connection on the suction side D_Ns	Rp 1
Pipe connection on the discharge side D_Nd	Rp 1

Ordering information

Brand	Wilo
Product description	MEDANA CH3-LE.403-2/V/1/10T
Net weight, approx. m	21.6 kg
Article number	4250149 

Mechanical accessories

Fittings

Shut-off valve

Ball valve Rp 1	2663980
-----------------	---------

Valves/accessories

Screwed connection for non-return valve

Screwed connection for non-return valve DN 25	2660509
---	---------

Electrical accessories

Pump control/accessories

Low-water cut-out switchgear kit for domestic water systems

low-water cut-out switchgear kit WMS G 1¼	4204510
low-water cut-out switchgear kit WMS G2	4204512

Pump control/interface module

CIF-Modules

CIF-Module BACnet MS/TP	2190367
CIF-Module Modbus RTU	2190368
CIF-Module CANopen	2190369
CIF-Module LON	2190370
CIF-Module PLR	2190371
CIF-Module Ethernet	2211408

Pressure control

Kit for differential pressure sensor

Kit differential pressure sensor 0-16 bar (for horizontal pumps)	4194672
--	---------

Pressure sensor for systems

Pressure sensor, 0 - 6 bar	2550660
Pressure sensor, 0 - 10 bar	2550661
Pressure sensor, 0 - 16 bar	2550662
Pressure sensor, 0 - 25 bar	2550663
Pressure sensor, 0 - 40 bar	2550664

Level control

Float switch WA

Float switch WA65 with 5 m cable	503211390
Float switch WA65 with 10 m cable	503211893
Float switch WA65 with 20 m cable	2004431
Float switch WA65 with 30 m cable	2004432
Float switch WA KR1 S with 5 m cable	6082806
Float switch WA KR1 S with 10 m cable	6082807

Float switch WA-EK

--	--

Float switch WAEK 65, 5 m cable	503211698
Float switch WAEK 65, 10 m cable	2005516
Float switch WAEK 65, 20 m cable	2005517

Float switch WAO

Float switch WAO 65, 5 m cable	503211595
Float switch WAO 65, 10 m cable	2006027
Float switch WAO 65, 20 m cable	2004429
Float switch WAO 65, 30 m cable	2004430

Float switch WAO-EK

Float switch WAOEK 65, 20 m cable	2005626
-----------------------------------	---------

Immersion probe

Submersible electrode, 3 m	500183799
Submersible electrode, 4 m	2516278
Submersible electrode, 5 m	500937990
Submersible electrode, 10 m	2501937
Submersible electrode, 20 m	2516283
Submersible electrode, 25 m	2000601
Submersible electrode, 30 m	2514045
Submersible electrode, 35 m	2516284
Submersible electrode, 40 m	2516285
Submersible electrode, 50 m	2500315
Submersible electrode without cable	64873

Motor protection

PTC thermistor tripping unit

PTC thermistor tripping unit	509275993
------------------------------	-----------

Services

With Wilo as your partner, you can not only be sure of choosing high-quality product solutions, but also of benefiting from a comprehensive, worry-free package of well thought-out services. We collaborate to develop a service concept tailored to your individual needs; with our expertise and personal consultancy, we make sure that the operation of your systems is as energy-efficient, reliable and economical as possible. All the while our competent Wilo service technicians are ready to assist you with fast, reliable and on-time support.

Recommended services

Commissioning FWJ/HiMulti 3-5	2219394
Commissioning Booster Set 1-2 pumps	2216414
Maintenance BASIC FWJ/HiMulti 3-5	2219534
Maintenance BASIC Booster Set 1-2 pumps	2160453
Maintenance COMFORT FWJ/HiMulti 3-5	2219496
Maintenance COMFORT Booster Set 1-2 pumps	2160468
Maintenance PREMIUM FWJ/HiMulti 3-5	2219549
Maintenance PREMIUM Booster Set 1-2 pumps	2160483
Wilo-Live Assistant Service	2216415

More suitable services

Extended Warranty Booster Set 1-2 pumps	2216416
Supervision FWJ/HiMulti 3-5	2219328
Supervision Booster Set 1-2 pumps	2216412
Installation FWJ/HiMulti 3-5	2219363
Installation Booster Set 1-2 pumps	2216413
System Optimisation FWJ/HiMulti 3-5	2219258
System Optimisation Booster Set 1-2 pump	2216410
Energy Solutions FWJ/HiMulti 3-5	2219293
Energy Solutions Booster Set 1-2 pumps	2216411
Repair FWJ/HiMulti 3-5	2219617
Repair Booster Set 1-2 pumps	2216417