



Data sheet

Hydraulic data

Maximum operating pressure P_N	10 bar
Head max H_{max}	6.0 m
Flow max Q_{max}	3.6 m ³ /h
Minimum suction head at 50 °C m	0.5 m
Minimum suction head at 95 °C m	3 m
Minimum suction head at 110 °C	10 m
Min. fluid temperature T_{min}	-10 °C
Max. fluid temperature T_{max}	95 °C
Max. fluid temperature at max. ambient temperature of +25 °C T_{max}	95 °C
Max. fluid temperature at max. ambient temperature of +40 °C T_{max}	95 °C
Min. ambient temperature T_{min}	-10 °C
Max. ambient temperature T_{max}	40 °C

Motor data

Energy efficiency index (EEI)	≤0.20
Mains connection	1~230 V ±10%, 50/60 Hz
Rated power P_2	30 W
Min. speed n_{min}	700 1/min
Max. speed n_{max}	4200 1/min
Power consumption $P_{1 min}$	4 W
Power consumption $P_{1 max}$	40 W
Emitted interference	EN 61000-6-3
Interference resistance	EN 61000-6-2
Electromagnetic compatibility	EN 61800-3
Threaded cable connection	1 x PG11
Insulation class	F
Protection class	IPX4D

Materials

Pump housing	Grey cast iron
Impeller	PP-GF40
Shaft	Stainless steel
Bearing	Carbon, metal-impregnated

Installation dimensions

Pipe connection on the discharge side DNd	G 1½
Pipe connection on the suction side DNs	G 1½
Port-to-port length $L0$	130 mm

Equipment/function

Function

Control mode	Δp -v for variable differential pressure
	Δp -c for constant differential pressure
	Constant speed (3 speed stages)
Display	Setpoint
	Actual volume flow
	Actual power consumption
	Fault signals (error codes)
Pump venting function	Manually activated restart or pump venting function
	Manual

Equipment

Approvals and labels	CE
	VDE
	EAC
Display	LED segment display
Display information	Basic Version: LED display (small) for showing the set head or speed stage.
Pump control	Electronic-controlled pump
Quick electrical connection	Wilo Connector
Thermal insulation shell	As accessory
Blocking-current proof motor	yes
Particle filter	yes
Operating elements	Green button

Pump curves

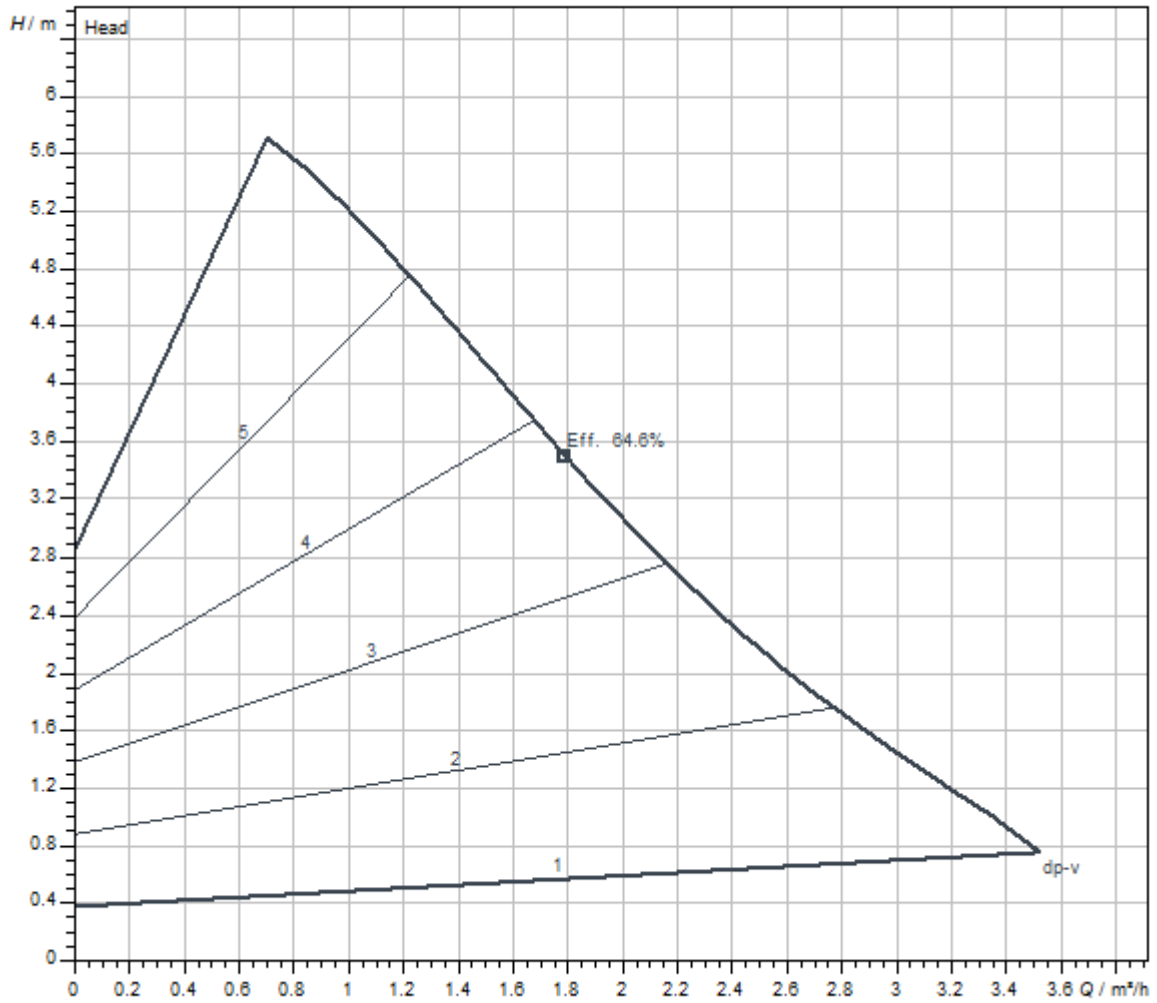

Fluid media	Water 100 %
Fluid temperature <i>T</i>	20.00 °C
speed at duty point <i>n hydr. @ OP</i>	2,900 1/min

Dimensions and dimensions drawings

Wilo-Yonos PICO 25/1-6-130 PN 10

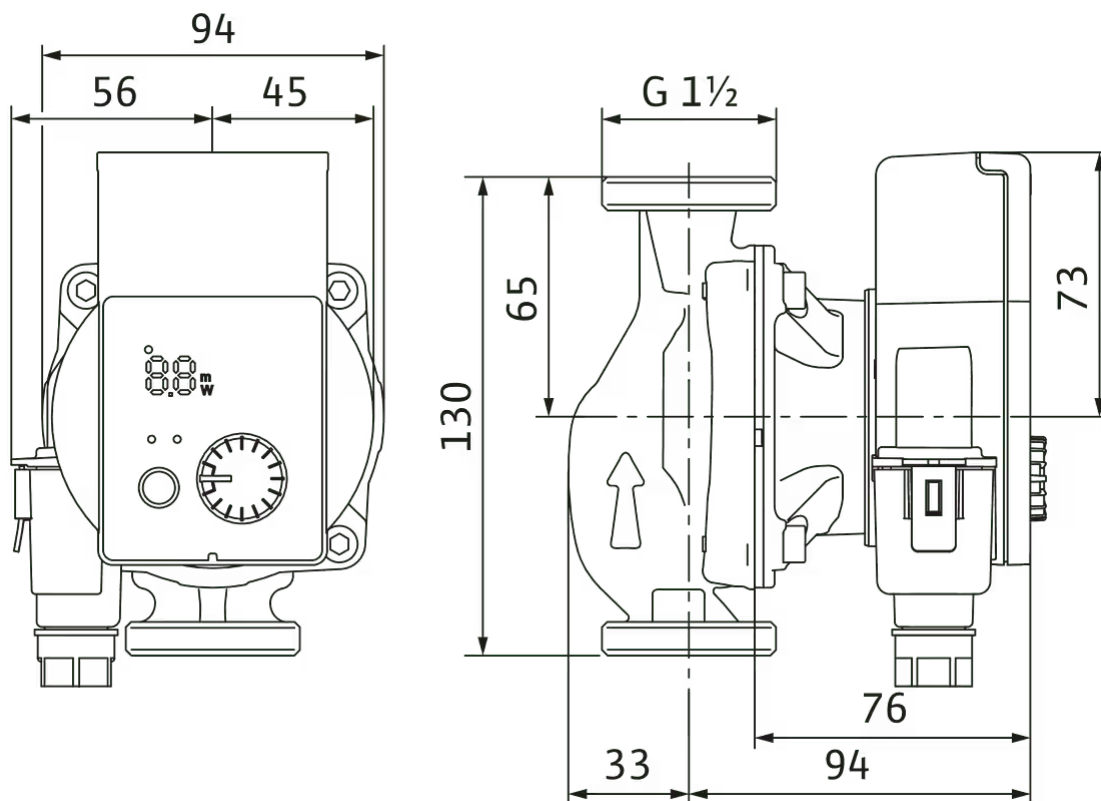

Wiring diagram

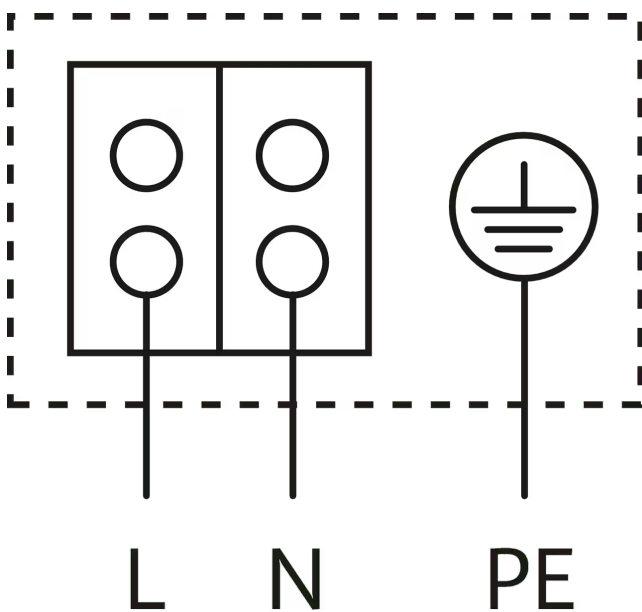

Blocking current-proof motor

Single-phase motor (EM) 2-pole - 1~230 V, 50 Hz

Tender text

High-efficiency pump Wilo-Yonos PICO, electronically controlled. Maintenance-free glandless circulator with screwed connection, blocking-current proof synchronous motor according to ECM technology and built-in electronic power control for variable differential pressure control. Can be used for all heating and air-conditioning applications. Control mode can be selected in accordance with the radiator/underfloor heating application.

Standard-equipped with:

- > Preselectable control modes for optimum load adjustment: Differential pressure constant (Δp -c), differential pressure variable (Δp -v), constant speed (3 pump curves)
- > Integrated motor protection

- > LED for setting the setpoint, displaying the current consumption in watts and the flow rate in m^3/h
- > Automatic deblocking function
- > Manual pump venting function for venting the rotor chamber
- > Manual restart

Operating Data

Min. fluid temperature T_{min}	-10 °C
Max. fluid temperature T_{max}	95 °C
Min. ambient temperature T_{min}	-10 °C
Max. ambient temperature T_{max}	40 °C
Maximum operating pressure PN	10 bar
Minimum suction head at 50 °C m	0.5 m
Minimum suction head at 95 °C m	3 m
Minimum suction head at 110 °C	10 m

Motor data

Energy efficiency index (EEI)	≤ 0.20
Emitted interference	EN 61000-6-3
Interference resistance	EN 61000-6-2
Mains connection	1~230 V, 50/60 Hz
Power consumption $P_{1\ max}$	40 W
Min. speed n_{min}	700 1/min
Max. speed n_{max}	4200 1/min
Protection class motor	IPX4D
Threaded cable connection	1 x PG11

Materials

Pump housing	Grey cast iron
Impeller	PP-GF40
Shaft	Stainless steel
Bearing	Carbon, metal-impregnated

Installation dimensions

Pipe connection on the suction side DNs	G 1½
Pipe connection on the discharge side DNd	G 1½
Port-to-port length $L0$	130 mm

Ordering information

Brand	Wilo
Product description	Yonos PICO 25/1-6-130
Net weight, approx. m	1.7 kg
Article number	4215516 

Mechanical accessories

Pipe installation

Screwed connections/adapters

Screwed connection Rp 1 x G 1½, 72 Set	112047298
Screwed connection Rp 1 x G 1½, 1 Set	4092741
Adapter G 1½/G 2	4105914

Pipe installation, adapter fitting

Flanged rings RF

Flanged ring RF 7, PN6	110628790
Flanged ring RF 9, PN6	110679395
Flanged ring RF 13, PN6	110679498
Flanged ring RF 10, PN6	110851499

Threaded adapter R

Threaded adapter R 2, GG	110626790
Threaded adapter R 6, GG	110678493
Threaded adapter R 1, GG	110786891
Threaded adapter R 7, GG	110787094
Threaded adapter R 24, GG	110880596

Thermal insulation

Thermal insulation shell

Thermal insulation shell	4206066
--------------------------	---------

Electrical accessories

Pump control

Timer switch SK 601N

Switchgear SK 601N	2120443
--------------------	---------

Plug

Angle plug

Angle plug	4150229
------------	---------

Connector

Wilo-Connector	4200870
----------------	---------

Services

With Wilo as your partner, you can not only be sure of choosing high-quality product solutions, but also of benefiting from a comprehensive, worry-free package of well thought-out services. We collaborate to develop a service concept tailored to your individual needs; with our expertise and personal consultancy, we make sure that the operation of your systems is as energy-efficient, reliable and economical as possible. All the while our competent Wilo service technicians are ready to assist you with fast, reliable and on-time support.

Recommended services

Wilo-Live Assistant Service	2216415
-----------------------------	---------

System Optimisation Glandless pumps	2219250
-------------------------------------	---------

Energy Solutions Glandless pumps	2219285
----------------------------------	---------

More suitable services

Extended Warranty Glandless pumps	2219589
-----------------------------------	---------

Supervision Glandless pumps	2219320
-----------------------------	---------

Installation Glandless pumps	2219355
------------------------------	---------

Commissioning Glandless pumps	2219390
-------------------------------	---------

Maintenance BASIC Glandless pumps	2219530
Maintenance COMFORT Glandless pumps	2219416
Maintenance PREMIUM Glandless pumps	2219545

Repair Glandless pumps	2219609
------------------------	---------