

GHV10/15SVX02F030/4/PMA

Technical data

Company name
Contact
Phone number
e-mail address

Operating data					
1	Pumpe type	Single-/Multi-pump set		Fluid	Water, pure
2	No. of pumps	1		Operating temperature t A	°C 4
3	Nominal flow	m ³ /h	0	pH-value at t A	7
4	Nominal head	m	0	Density at t A	kg/m ³ 1000
5	Static head	m	0	Vapor pressure at t A	kPa 100
6	Inlet pressure	kPa	0	Kin. viscosity at t A	mm ² /s 1.569
7	Environmental temperature	°C	20	Altitude	0
8	Available system NPSH	m	0		

Pump data					
9	Product version	[X] - Hydrovar X+			
10	Operating speed	3600 rpm			
11	Stages	2			
12	Max. working pressure	kPa	418.7		
13	Head H(Q=0)	m	43		
14	Max. shaft power	kW	3.8		
15	Shaft power	kW			
16	Power input	kW			
17	Efficiency	%			
18	Overall efficiency	%			
19	NPSH 3%	m			
20	Total weight	kg	85.0		
21					

Materials					
Pump			Options		
23	Manifolds	Stainless steel, 1.4301, AISI 304	GHV Non-return valve	Non return valve in delivery side	
24	On-off valves ball type	Nickel-plated brass	Additional Card	No card	
25	Non-return valves	Brass	N.A.		
26	Pressure switches	Galvanized steel/AISI 301	N.A.		
27	Pressure trasmitters	AISI 304L & AISI 316L	Control Devices Oversized	Standard	
28	Caps/plugs	AISI 304 or superior	N.A.		
29	Sliding/Blind flanges	Galvanized steel	N.A.		
30	Welded flanges	Stainless steel, 1.4301, AISI 304	N.A.		
31	Fittings	Stainless steel, 1.4401, AISI 316	N.A.		
32	Bracket	Galvanized steel/painted steel	N.A.		
33	Base	Painted steel	N.A.		
34			Control Panel Options	Standard	
35			N.A.		
36			Double Pressure Transmitter	Standard	
37			Electric Pump Special Seals	Standard	
38			N.A.		
39			High Pressure Protection	Without high pressure protection on delivery	
40			Non-return Valve	Standard non-return valve	
41			Operating Voltage	Standard voltage	

Motor data					
42	Manufacturer	Lowara e-XM		Pressure Transmitter	Standard
43	Specific design	IE5 Three phase motor		Protection Against Dry Running	/PMA Minimum pressure protection switch and vacuum gauge on suction side
44	Type	EXM100B5/4.030BH2		Pump Test	Set without certified pumps
45	Rated power	3 kW	Rated current	6.7 A	N.A.
46	Nominal speed	3600 rpm	Rated voltage	380 V	N.A.
47	Frame size	100	Motor efficiency	% 87.8	
48	Weight	kg 24.7	Power factor	0.86	

Remarks					
49					
50					
50					
52					

GHV10/15SVX02F030/4/PMA

Performance curve

Company name
Contact
Phone number
e-mail address

Ø	Pump capacity			Pump head		Frequency	Hz	50/60
	Operating range	η	η	H(Q=0)	η			
	Min. m³/h	Max. m³/h	Max. m³/h	m	m	Operating speed	rpm	
Max.	10.2	29.2	20.6	42.7	34.5	Nominal flow	m³/h	0
						Nominal head	m	0
						Inlet pressure	kPa	0
						Static head	m	0

Power datas referred to:

Water, pure [100%] ; 4°C; 1000kg/m³; 1.57mm²/s

hydr. Performance acceptance acc. To EN ISO 9906 Class

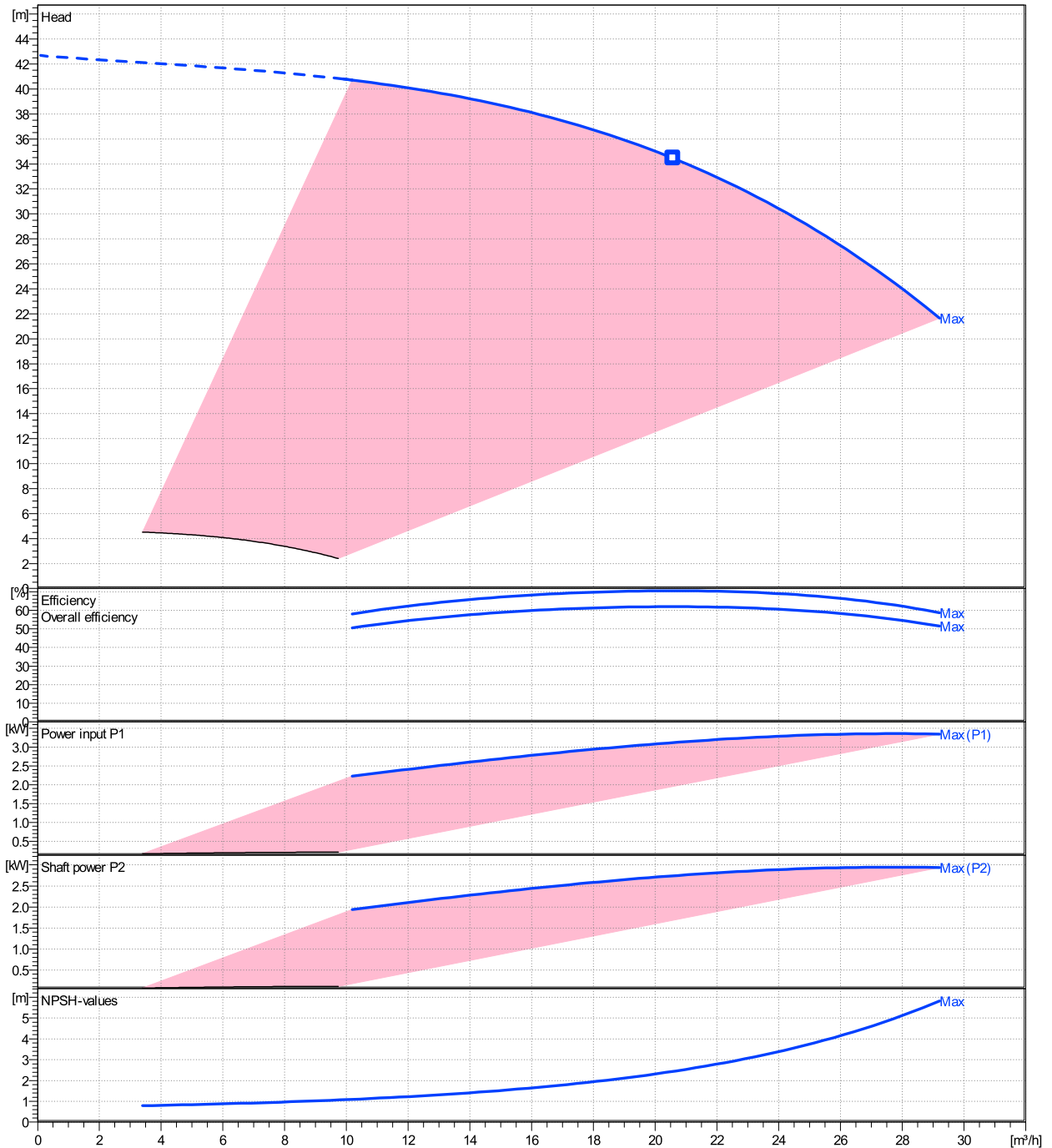

GHV10/15SVX02F030/4/PMA

Dimensions

Company name
Contact
Phone number
e-mail address

[X] - Hydrovar X+
EXM100B5/4.030BH2

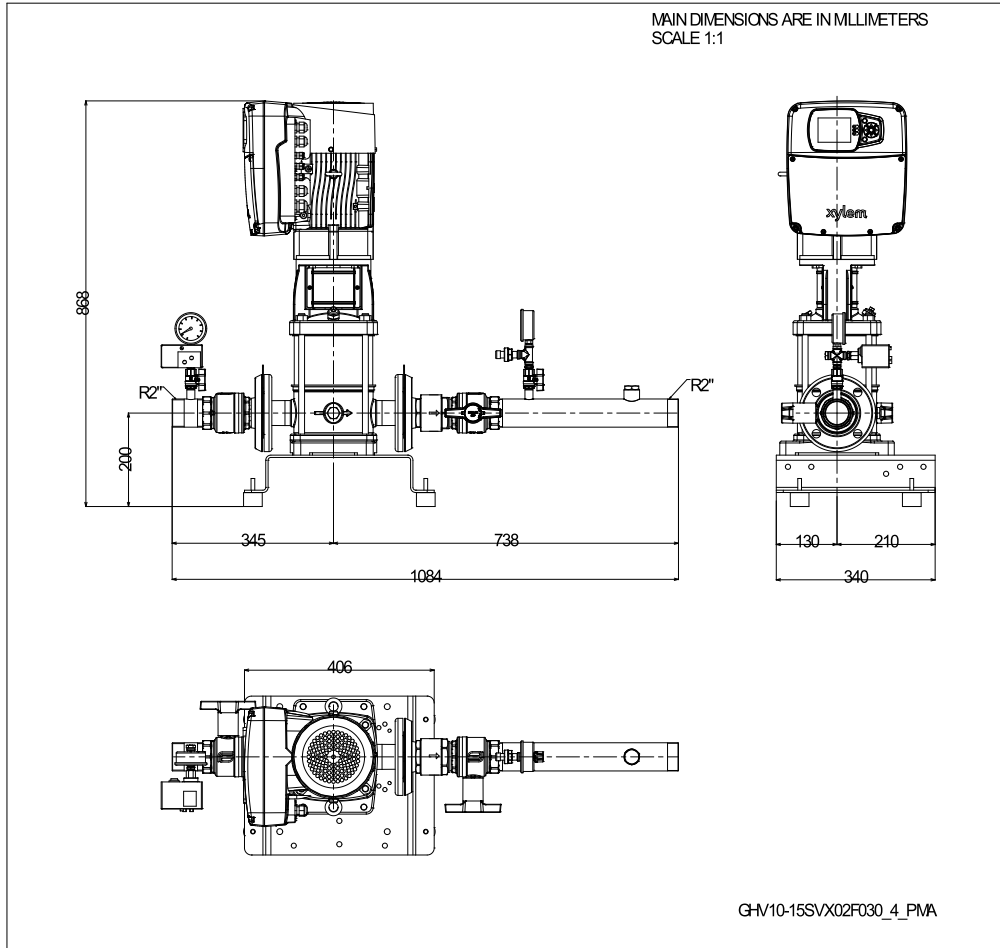

Dimensions [mm]	
A	345
B	738
C	1084
DNA	R 2"
DNM	R 2"
H	200
H2	868
Weight	
Total weight	85 kg

Dimensions and weight without obligation

Project	Xylect-22319385	Created by		Last update	5/20/2024
Block	GHV10/15SVX02F030/4/PMA	Created on	5/20/2024		

GHV10/15SVX02F030/4/PMA

Technical data

Company name
Contact
Phone number
e-mail address



REF.	ITEM	DESCRIPTION	DEFAULT
1		Power supply +24 VDC, max. 60mA (total, terminals 1 + 5)	
2	Analog Input 1	Configurable Analog Input 1	Pressure Sensor 1
3		Electronic GND	
4	Not used	Internal use - Do not connect	
5		Power supply +24 VDC, max. 60mA (total, terminals 1 + 5)	
6	Analog Input 2	Configurable Analog Input 2	Not used
7		Electronic GND	
8	External Start/Stop	Start/Stop digital input, +24 VDC internal pull-up, 6mA contact current	-
9		Electronic GND	
10	External Lack of Water	Low water digital input, +24 VDC internal pull-up, 6mA contact current	-
11		Electronic GND	
12	Digital Input 3	Configurable Digital Input 3, +24 VDC internal pull-up, 6mA contact current	Solo Run
13		Electronic GND	
14	Analog Output	Configurable Analog Output	Motor Speed
15		Electronic GND	
16		Power supply +24 VDC, max. 60mA (total, terminals 16 and 19)	
17	Analog Input 3	Configurable Analog Input 3	Not used
18		Electronic GND	
19		Power supply +24 VDC, max. 60mA (total, terminals 16 and 19)	
20	Analog Input 4	Configurable Analog Input 4	Not used
21		Electronic GND	
22	Digital Input 4	Configurable Digital Input 4, +24 VDC internal pull-up, 6mA contact current	Not used
23		Electronic GND	
24	Digital Input 5	Configurable Digital Input 5, +24 VDC internal pull-up, 6mA contact current	Not used
25		Electronic GND	
26	10 VDC supply	Power supply +10 VDC, max. 3mA	-
27		Electronic GND	
28		RS485 port 1 : RS485-1B N (-)	
29	Communication bus 1	RS485 port 1 : RS485-1A P (+)	Multipump
30		RS485 port 1 : RS485-COM	
31		RS485 port 2 : RS485-2B N (-)	
32	Communication bus 2	RS485 port 2 : RS485-2A P (+)	Modbus
33		RS485 port 2 : RS485-COM	
34		RS485 port 1 : RS485-1B N (-)	
35	Communication bus 1	RS485 port 1 : RS485-1A P (+)	Multipump
36		RS485 port 1 : RS485-COM	
37		RS485 port 2 : RS485-2B N (-)	
38	Communication bus 2	RS485 port 2 : RS485-2A P (+)	Modbus
39		RS485 port 2 : RS485-COM	
40		Configurable relay 1: Normally Open	
41	Relay 1	Configurable relay 1: Normally Closed	Running
42		Configurable relay 1: Common Contact	
43		Configurable relay 2: Normally Open	
44	Relay 2	Configurable relay 2: Normally Closed	Error
45		Configurable relay 2: Common Contact	