

Qty. Description

1 **SSP-3.0 B**



Note! Product picture may differ from actual product

Product No.: [96787464](#)

Grundfos SSP-3.0 B is a premium brass shower pump with positive head and 1 impeller, designed and manufactured to the highest standards.

The shower pump is continuously rated as a regenerative pump making it equipped to overcome air pockets and ideal where the plumbing route includes multiple bends and elbows.

This shower pump ensures high performance, long durability and is suitable for domestic, commercial or light industrial use to boost shower pressure up to 4 bar.

The shower pump is used for boosting either hot or cold water to single showers, multiple showers or whole house boosting where the outlets are below the cold-water tank.

The shower pump is characterized as heavy-duty and it relies upon brass impellers and machined brass stampings for improved durability and high performance.

The pump is supplied with a stainless steel, flexible and braided connection hose making it resistant to corrosion.

Anti-vibration feet and long-life silicon carbide seals ensure that the operating noise is held at a minimum.

The shower pump has built-in thermal protection, which immediately stops the pump motor if it overheats.

The shower pump is a WRAS approved product and as such the whole product has undergone and passed extensive mechanical and water quality testing. Additionally, this pump is a regenerative pump making it equipped to overcome air pockets.

- Brass impellers and housing for high performance and improved durability.
- Integrated thermal protection
- Regenerative impeller design to overcome air pockets
- Low speed and quiet induction motor for longer durability
- Continuously rated regenerative pump (in UK is used)
- Long life carbide seals
- Stainless steel flexible connection hose
- Anti-vibration feet for minimum operating noise
- WRAS approved product

Controls:

Flow switch (Yes/No): Y

Pressure switch Yes/No: Y

Liquid:

Pumped liquid: Water

Liquid temperature range: 5 .. 60 °C

Selected liquid temperature: 20 °C

Density: 998.2 kg/m³

Technical:

Rated flow: 0.6 m³/h

Rated head: 20.1 m

Code for shaft seal: GBQP

Approvals: CE,WRAS

Qty. Description

1	<p>Approvals for drinking water: WRAS Curve tolerance: ISO9906:2012 3B</p> <p>Materials: Pump housing: Brass Impeller: Brass</p> <p>Installation: Range of ambient temperature: 0 .. 40 °C Maximum operating pressure: 6 bar Type of inlet connection: Push fit Type of outlet connection: Push fit Size of inlet connection: 22 Size of outlet connection: 22 Pressure rating for connection: PN 6</p> <p>Electrical data: Motor type: INDUCTION P1 max.: 410 W Mains frequency: 50 Hz Rated voltage: 1 x 230 V Rated current: 1.8 A Capacitor size - run: 10 µF/450 V Enclosure class (IEC 34-5): X2 Insulation class (IEC 85): F Built-in motor protection: YES Length of cable: 1.5 m Type of cable plug: NO</p> <p>Others: Net weight: 6.1 kg Gross weight: 6.9 kg Shipping volume: 0.02 m³ Country of origin: GB Custom tariff no.: 84137081</p>
---	---

Description	Value
General information:	
Product name:	SSP-3.0 B
Product No:	96787464
EAN number:	5700310312514
Technical:	
Rated flow:	0.6 m ³ /h
Rated head:	20.1 m
Maximum head:	30 m
Code for shaft seal:	GBQP
Approvals:	CE,WRAS
Approvals for drinking water:	WRAS
Curve tolerance:	ISO9906:2012 3B
Model:	A
Materials:	
Pump housing:	Brass
Impeller:	Brass
Installation:	
Range of ambient temperature:	0 .. 40 °C
Maximum operating pressure:	6 bar
Type of inlet connection:	Push fit
Type of outlet connection:	Push fit
Size of inlet connection:	22
Size of outlet connection:	22
Pressure rating for connection:	PN 6
Liquid:	
Pumped liquid:	Water
Liquid temperature range:	5 .. 60 °C
Selected liquid temperature:	20 °C
Density:	998.2 kg/m ³
Electrical data:	
Motor type:	INDUCTION
P1 max.:	410 W
Mains frequency:	50 Hz
Rated voltage:	1 x 230 V
Rated current:	1.8 A
Capacitor size - run:	10 µF/450 V
Enclosure class (IEC 34-5):	X2
Insulation class (IEC 85):	F
Built-in motor protection:	YES
Length of cable:	1.5 m
Type of cable plug:	NO
Controls:	
Flow switch (Yes/No):	Y
Pressure switch Yes/No:	Y
Others:	
Net weight:	6.1 kg
Gross weight:	6.9 kg
Shipping volume:	0.02 m ³
Country of origin:	GB
Custom tariff no.:	84137081

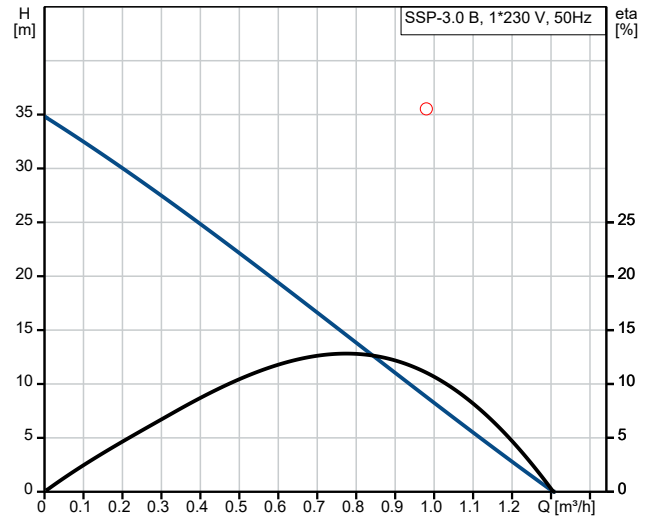

Pumped liquid = Water
 Liquid temperature during operation = 20 °C
 Density = 998.2 kg/m³

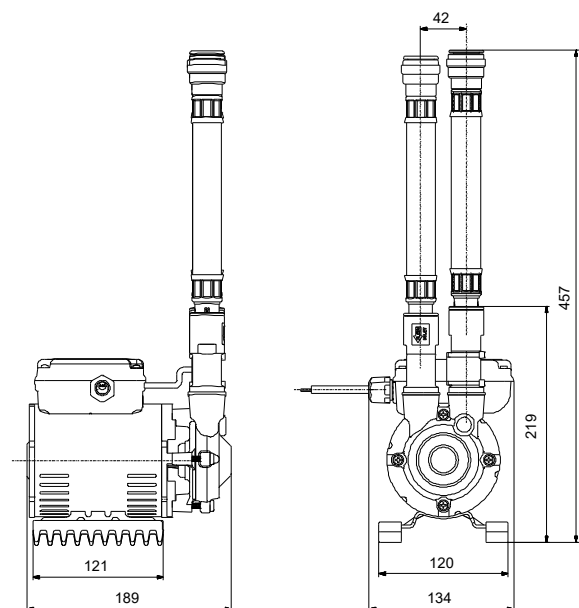
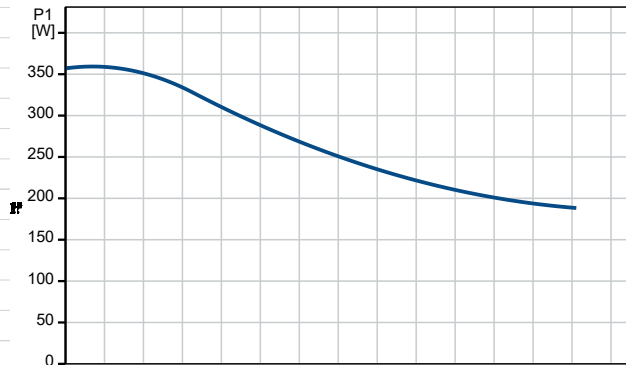

96787464 SSP-3.0 B 50 Hz

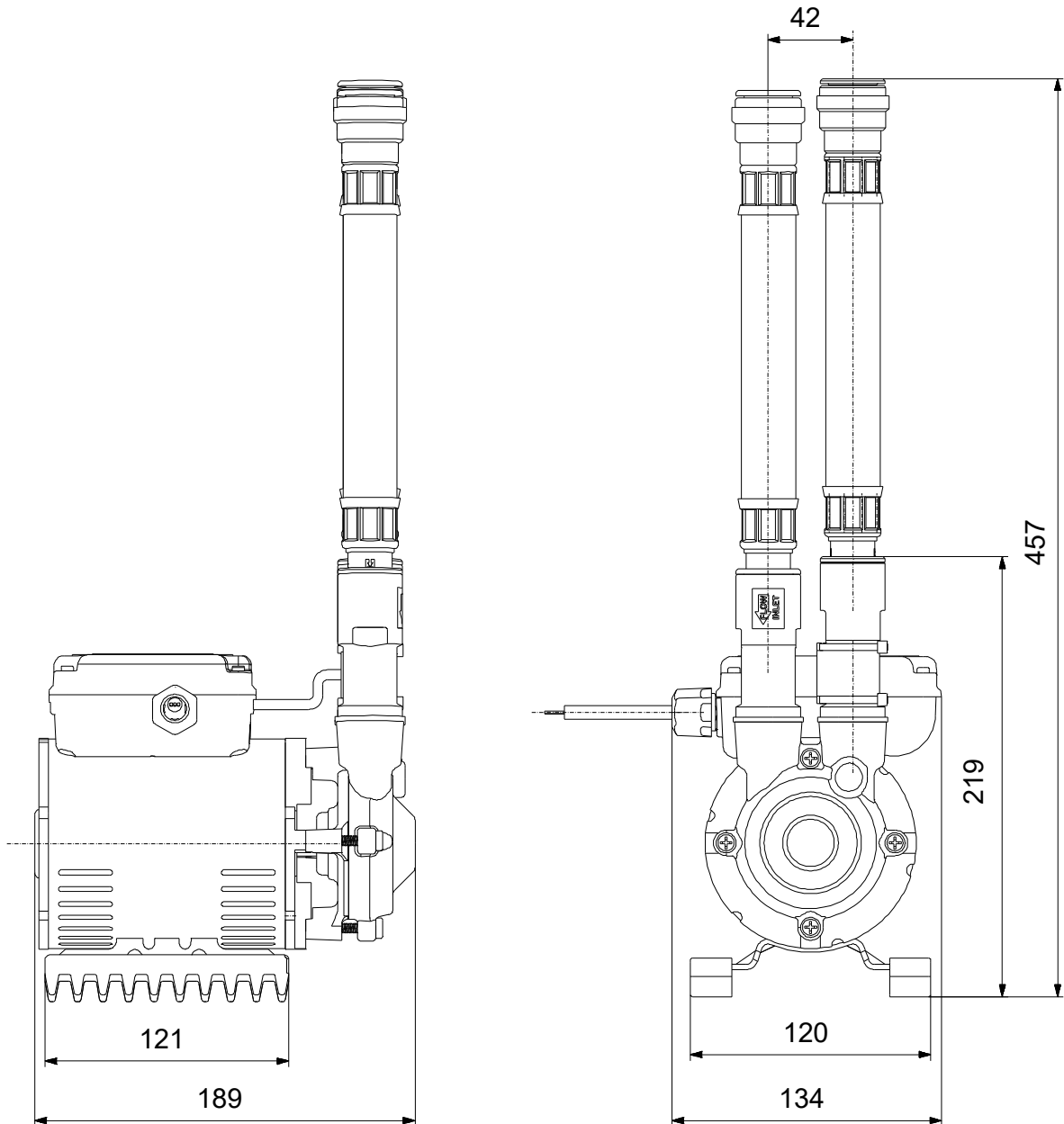

Note! All units are in [mm] unless others are stated.
Disclaimer: This simplified dimensional drawing does not show all details.