

SMB10/15SVE01F011/T4

Technical data

Company name
Contact
Phone number
e-mail address

Operating data							
1	Nominal flow	m ³ /h	0	Fluid	Water, pure		
2	Nominal head	m	0	Operating temperature t A	°C 4		
3	Static head	m	0	pH-value at t A	7		
4	Inlet pressure	kPa	0	Density at t A	kg/m ³ 1000		
5	Environmental temperature	°C	20	Kin. viscosity at t A	mm ² /s 1.569		
6	Available system NPSH	m	0	Vapor pressure at t A	kPa 100		
7	Solids		0	Altitude	m 0		
8							
Pump data							
9	Pump designation			Impeller Ø	Max.	mm	
10	SMB10/15SVE01F011/T4				designed	mm	
11	Design	Variable speed			Min.	mm	
12	Make				Flow	Nominal	m ³ /h ()
13				Max-		m ³ /h 29	
14	Speed	rpm	2900	Min-		m ³ /h 10.2	
15					Head	Nominal	m
16	Max. working pressure	kPa	202.3	at Qmax		m 3.2	
17	Head H(Q=0)	m	21	at Qmin		m 19.4	
18	Weight	kg	On demand	Shaft power	kW ()		
19	Weight data include external package			Max. shaft power	kW	1.2	
20				Efficiency	%		
21				NPSH 3%	m		
Materials							
22	Booster			Motor data			
23	Non-return valves	Brass		Manufacturer	Lowara	Electric voltage	240 V
24	Pressure switches	Galvanized steel/AISI 301		Specific design	Three phase e-SM motor		
25	Pressure transmitters	Stainless steel, 1.4301, AISI 304		Type	ESM90R/311 SVE	Electric current	4.69 A
26	Caps/plugs/flanges	AISI 304 / 316		Rated power	1.1 kW	Degree of protection	IP 55
27	Fittings	AISI 304 / 316		Speed	3600 rpm	Insulation class	F
28				Frame size	90R		RAL 5010
29				Weight	0 kg		
30							
31							
32							
Standard options							
33	Non return valve position	Non return valve in delivery side					
34	Set certificate						
35	Material Combination	SMB10 - Standard materials combination					
36	Pump Test	Set without certified pumps					
37	High pressure protection	Without high pressure protection on delivery					
38	Turned Delivery Manifold						
39	Oversize Piping						
40	Control Panel option						
41	Protection Against Dry Running	Without protection against dry running					
42	Control Devices Oversized	Standard					
43	Delivery Side						
44	Suction side						
45	Pressure Transmitter						
46	Control Panel Position						
47	Electric Pump Special Seals						
48	Non-return Valve	Standard non-return valve					

SMB10/15SVE01F011/T4

Performance curve

Company name
Contact
Phone number
e-mail address

Operating Data Specification

Flow 0 m³/h
Head 0 m
Static head 0 m

Hydraulic data (duty point)

Flow
Head

Impeller design

Impeller R 0 mm
Frequency 50 Hz
Speed 2900 rpm

Power datas referred to:

Water, pure [100%]; 4°C; 1000kg/m³; 1.57mm²/s
Performance according to ISO 9906:2012 – Grade 3B

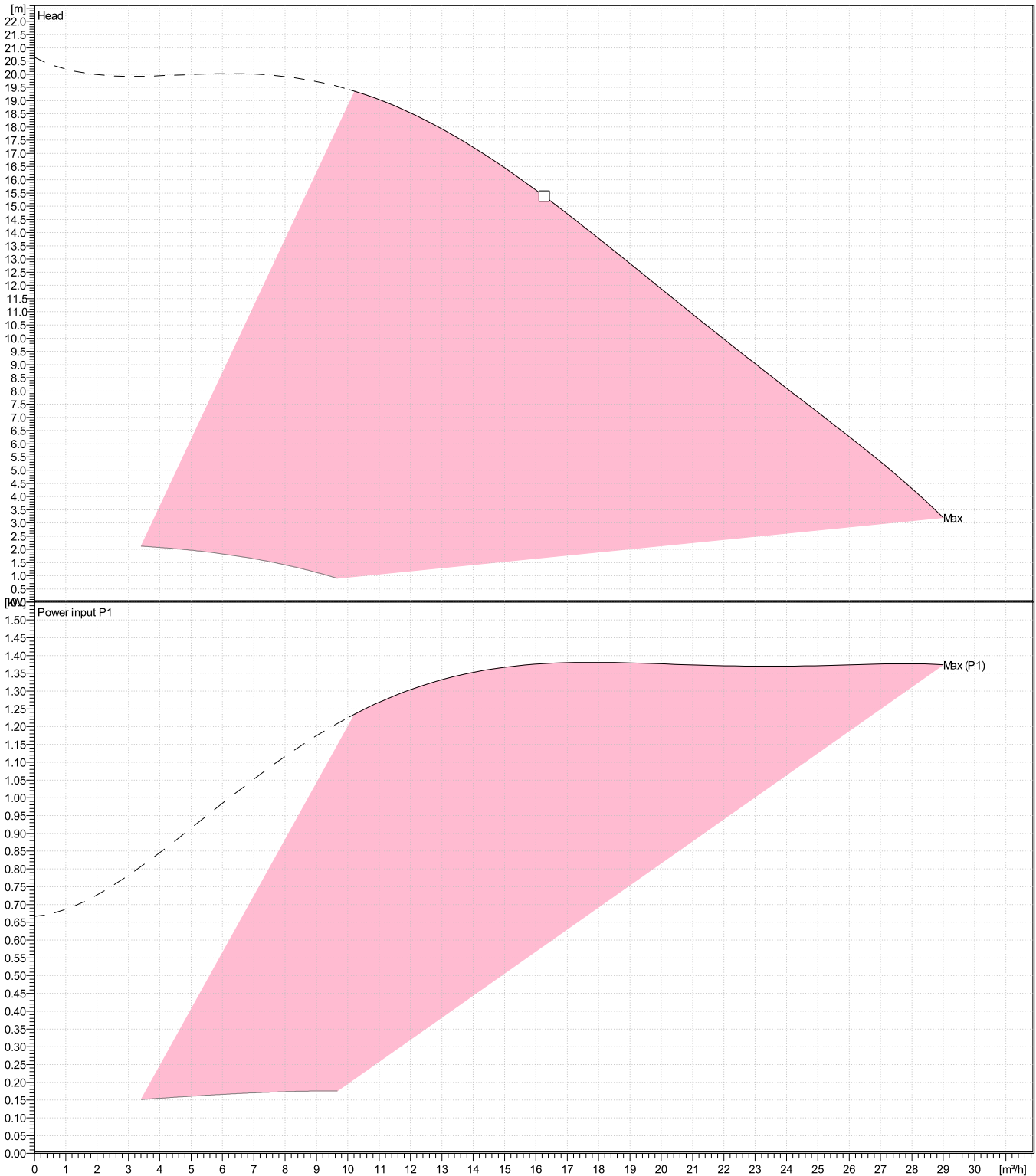

SMB10/15SVE01F011/T4

Dimensions

Company name
Contact
Phone number
e-mail address

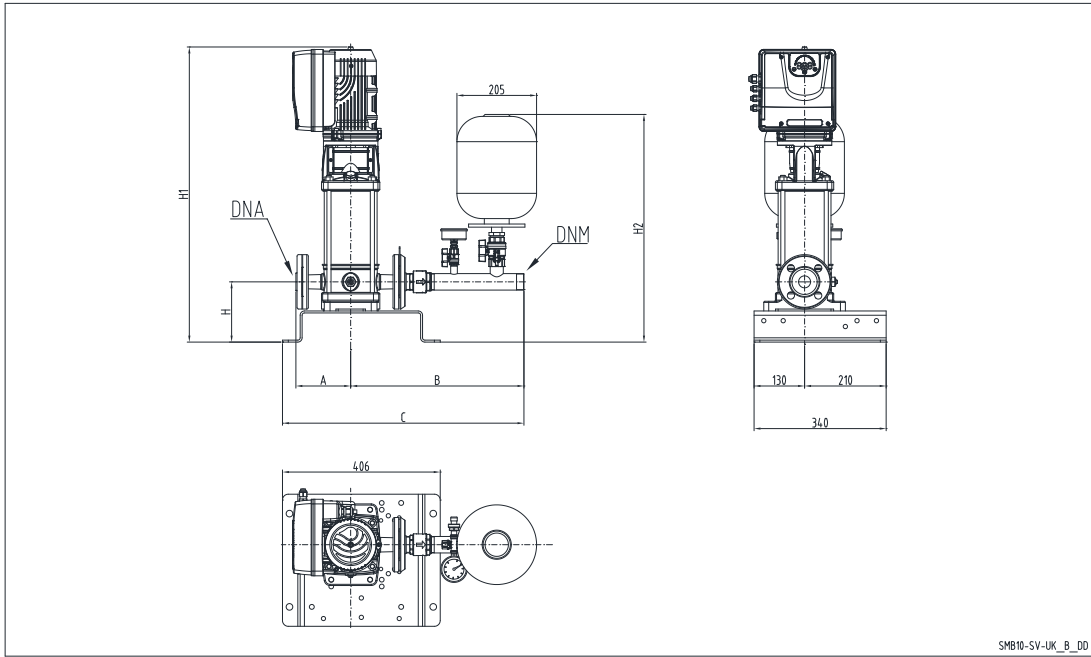

PLEASE NOTE:

Dimensions

mm

A	177					Weight (Include external package) On demand
B	534					
C	709					
DNA	Rp2"					
DNM	R2"					
H	170					
H1	741					
H2	743					

Project	Xylect-20943244	Created by		Last update	8/2/2023
Block	SMB10/15SVE01F011/T4	Created on	8/2/2023		