

SMB10/10SVE02F007/M2

Technical data

Company name
Contact
Phone number
e-mail address

Operating data					
1	Nominal flow	m ³ /h	0	Fluid	Water, pure
2	Nominal head	m	0	Operating temperature t A	°C 4
3	Static head	m	0	pH-value at t A	7
4	Inlet pressure	kPa	0	Density at t A	kg/m ³ 1000
5	Environmental temperature	°C	20	Kin. viscosity at t A	mm ² /s 1.569
6	Available system NPSH	m	0	Vapor pressure at t A	kPa 100
7	Solids		0	Altitude	m 0
8					
Pump data					
9	Pump designation			Impeller Ø	Max. mm 96
10	SMB10/10SVE02F007/M2			designed	mm 96
11	Design	Variable speed		Min.	mm 96
12	Make			Flow	Nominal m ³ /h ()
13				Max-	m ³ /h 17
14	Speed	rpm	2900	Min-	m ³ /h 5.1
15				Head	Nominal m
16	Max. working pressure	kPa	238.8	at Qmax	m 3.8
17	Head H(Q=0)	m	24	at Qmin	m 23.1
18	Weight	kg	On demand	Shaft power	kW ()
19	Weight data include external package			Max. shaft power	kW .8
20				Efficiency	%
21				NPSH 3%	m
Materials					
22		Booster		Motor data	
23	Non-return valves	Brass		Manufacturer	Lowara Electric voltage 208 V
24	Pressure switches	Galvanized steel/AISI 301		Specific design	Single phase e-SM motor
25	Pressure transmitters	Stainless steel, 1.4301, AISI 304		Type	ESM90R/107 SVE Electric current 6.2 A
26	Caps/plugs/flanges	AISI 304 / 316		Rated power	0.75 kW Degree of protection IP 55
27	Fittings	AISI 304 / 316		Speed	3600 rpm Insulation class F
28				Frame size	90R RAL 5010
29				Weight	0 kg
30					
31					
32					
Standard options					
33	Non return valve position			Non return valve in delivery side	
34	Set certificate				
35	Material Combination			SMB10 - Standard materials combination	
36	Pump Test			Set without certified pumps	
37	High pressure protection			Without high pressure protection on delivery	
38	Turned Delivery Manifold				
39	Oversize Piping				
40	Control Panel option				
41	Protection Against Dry Running			Without protection against dry running	
42	Control Devices Oversized			Standard	
43	Delivery Side				
44	Suction side				
45	Pressure Transmitter				
46	Control Panel Position				
47	Electric Pump Special Seals				
48	Non-return Valve			Standard non-return valve	

SMB10/10SVE02F007/M2

Performance curve

Company name
Contact
Phone number
e-mail address

Operating Data Specification

Flow 0 m³/h
Head 0 m
Static head 0 m

Hydraulic data (duty point)

Flow
Head

Impeller design

Impeller R 96 mm
Frequency 50 Hz
Speed 2900 rpm

Power datas referred to:

Water, pure [100%]; 4°C; 1000kg/m³; 1.57mm²/s
Performance according to ISO 9906:2012 – Grade 3B

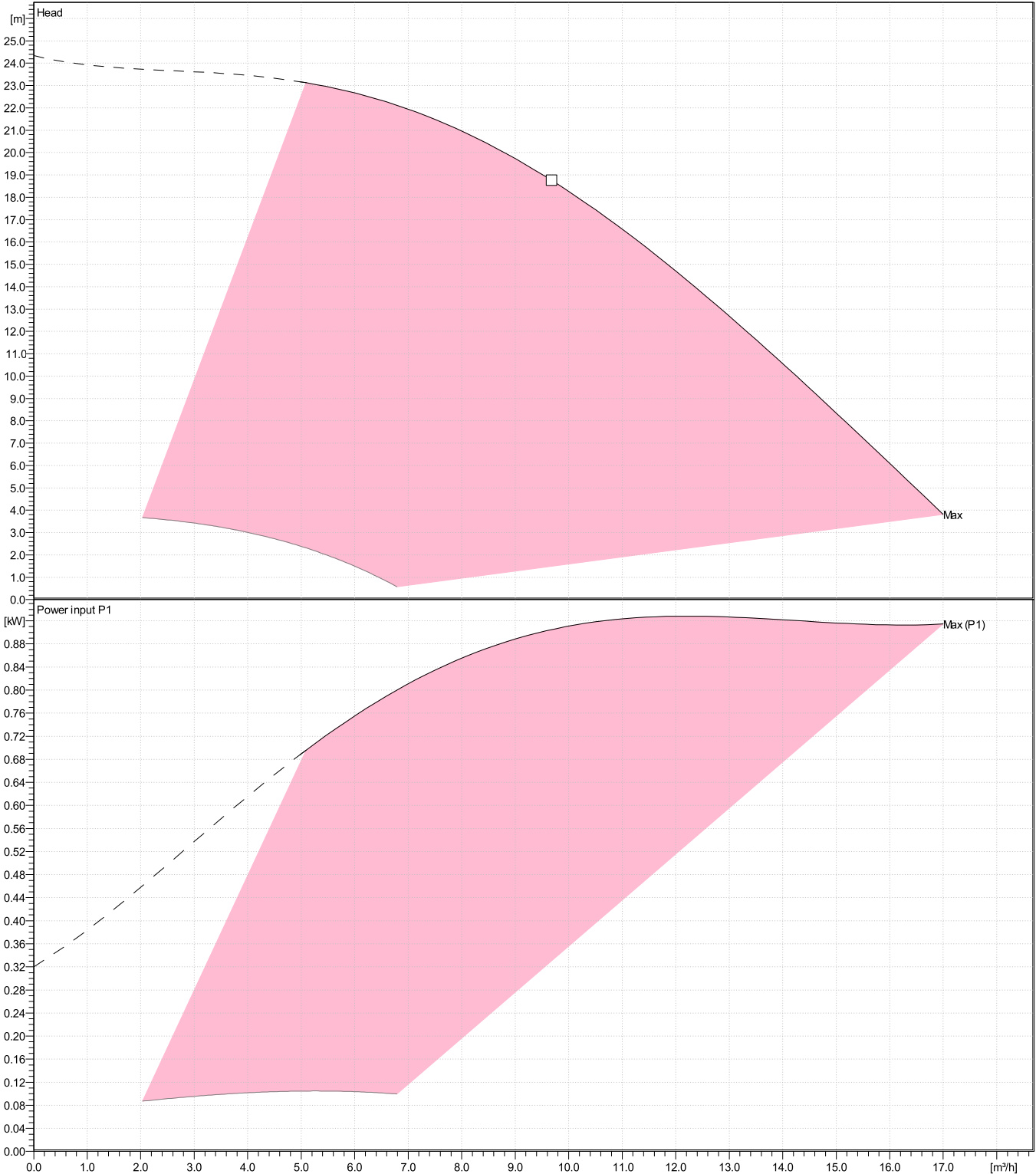

SMB10/10SVE02F007/M2

Dimensions

Company name
Contact
Phone number
e-mail address

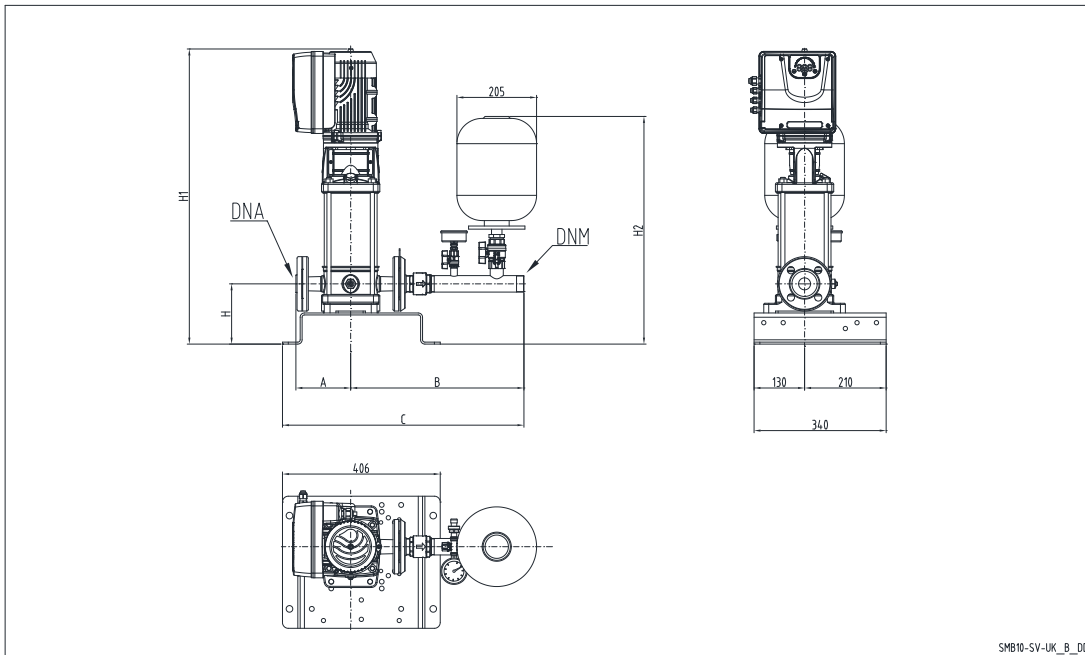

SMB10-SV-UK_B_DD

PLEASE NOTE:

Dimensions

mm

A	162					Weight (Include external package) On demand
B	455					
C	630					
DNA	Rp1"1/2					
DNM	R1"1/2					
H	160					
H1	689					
H2	594					

Project	Xylect-20943622	Created by		Last update	8/2/2023
Block	SMB10/10SVE02F007/M2	Created on	8/2/2023		