



**SMB20/15SVE02F015/T4/UK**

**Performance curve**

Company name  
Contact  
Phone number  
e-mail address

**Operating Data Specification**

Flow 0 m<sup>3</sup>/h  
Head 0 m  
Static head 0 m

**Hydraulic data (duty point)**

Flow  
Head

**Impeller design**

Impeller R 0 mm  
Frequency 50 Hz  
Speed 2900 rpm

**Power datas referred to:**

Water, pure [100%]; 4°C; 1000kg/m<sup>3</sup>; 1.57mm<sup>2</sup>/s  
Performance according to ISO 9906:2012 – Grade 3B

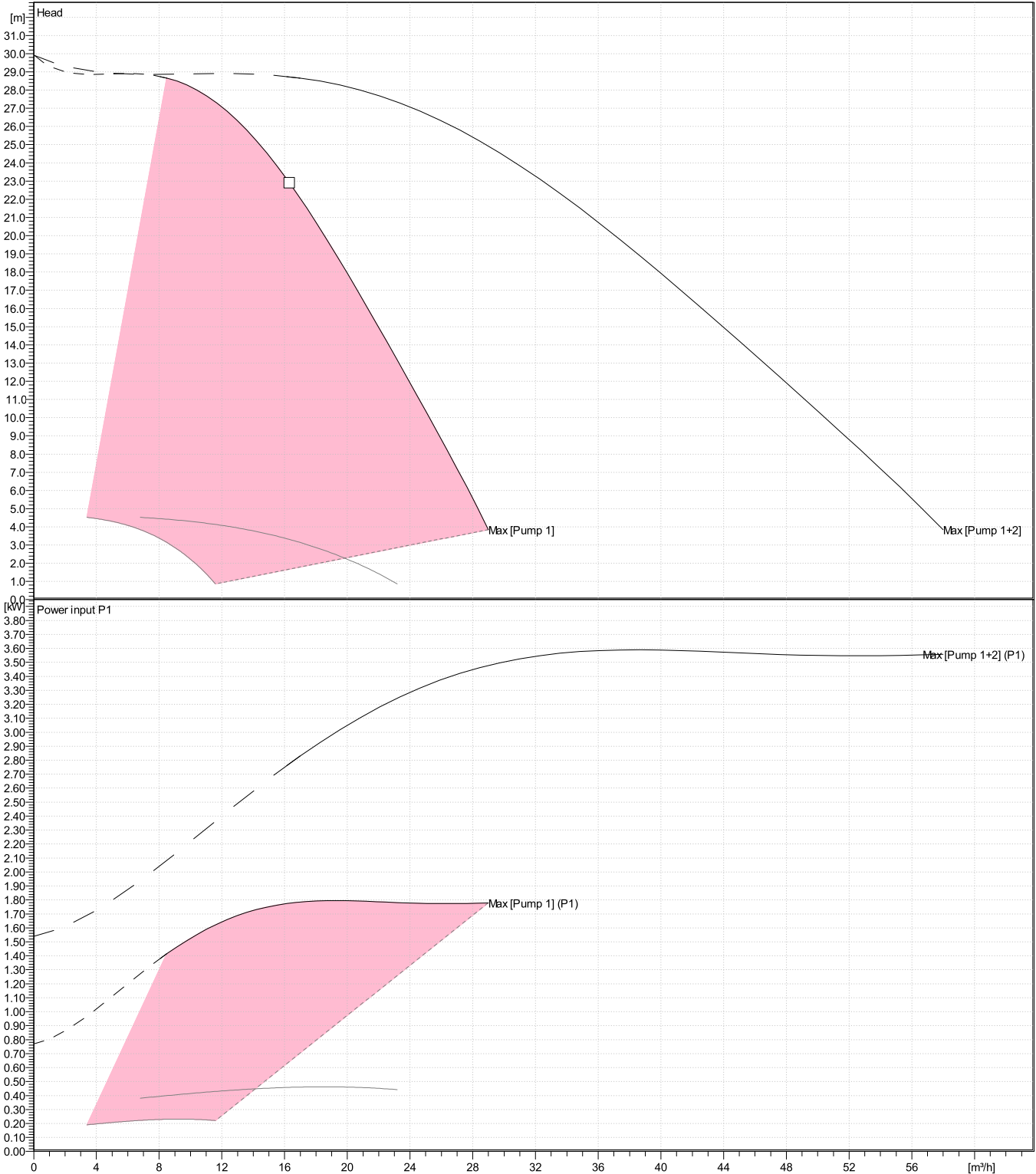

**Dimensions**

Company name  
Contact  
Phone number  
e-mail address

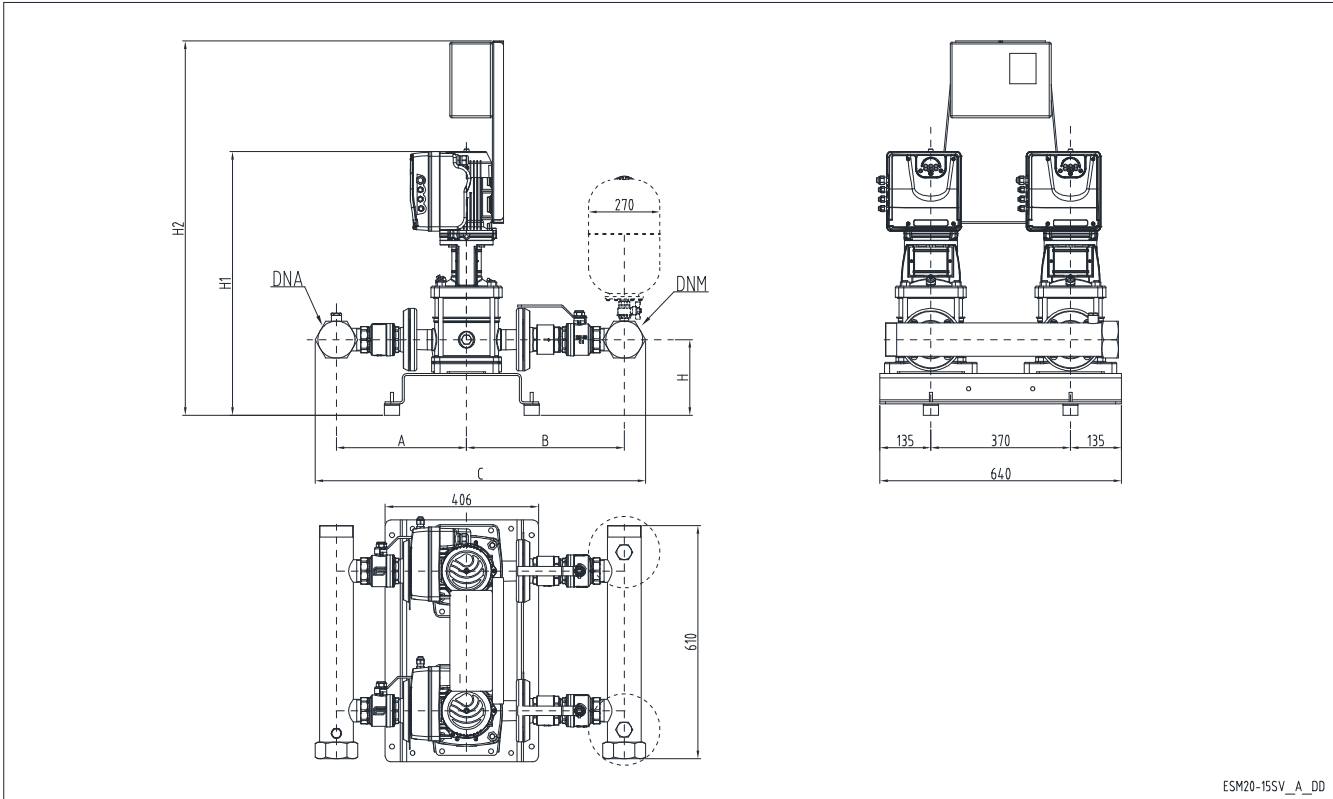

ESM20-15SV\_A\_DD

**PLEASE NOTE:**

**Dimensions**

mm

A	345					Weight (Include external package) On demand
B	418					
C	851					
DNA	R3"					
DNM	R3"					
H	200					
H1	771					
H2	1145					

<b>Project</b>	Xylect-20864219	<b>Created by</b>		<b>Last update</b>	7/17/2023
<b>Block</b>	SMB20/15SVE02F015/T4/UK	<b>Created on</b>	7/17/2023		