

SMB20/3SVE09F011/M2/UK

Performance curve

Company name
Contact
Phone number
e-mail address

Operating Data Specification

Flow 0 m³/h
Head 0 m
Static head 0 m

Hydraulic data (duty point)

Flow
Head

Impeller design

Impeller R 79 mm
Frequency 50 Hz
Speed 2900 rpm

Power datas referred to:

Water, pure [100%] ; 4°C; 1000kg/m³; 1.57mm²/s
Performance according to ISO 9906:2012 – Grade 3B

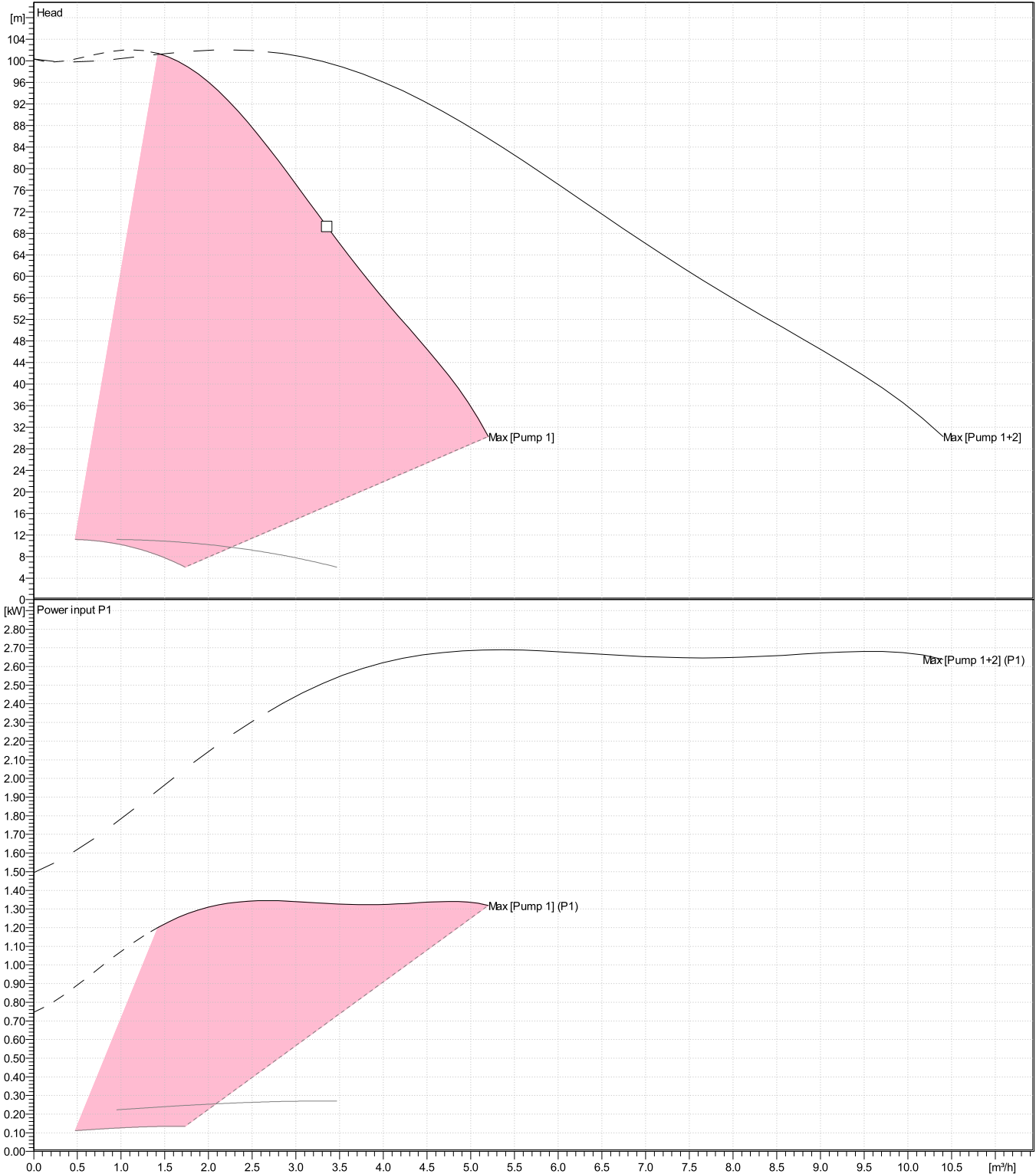

Dimensions

Company name
Contact
Phone number
e-mail address

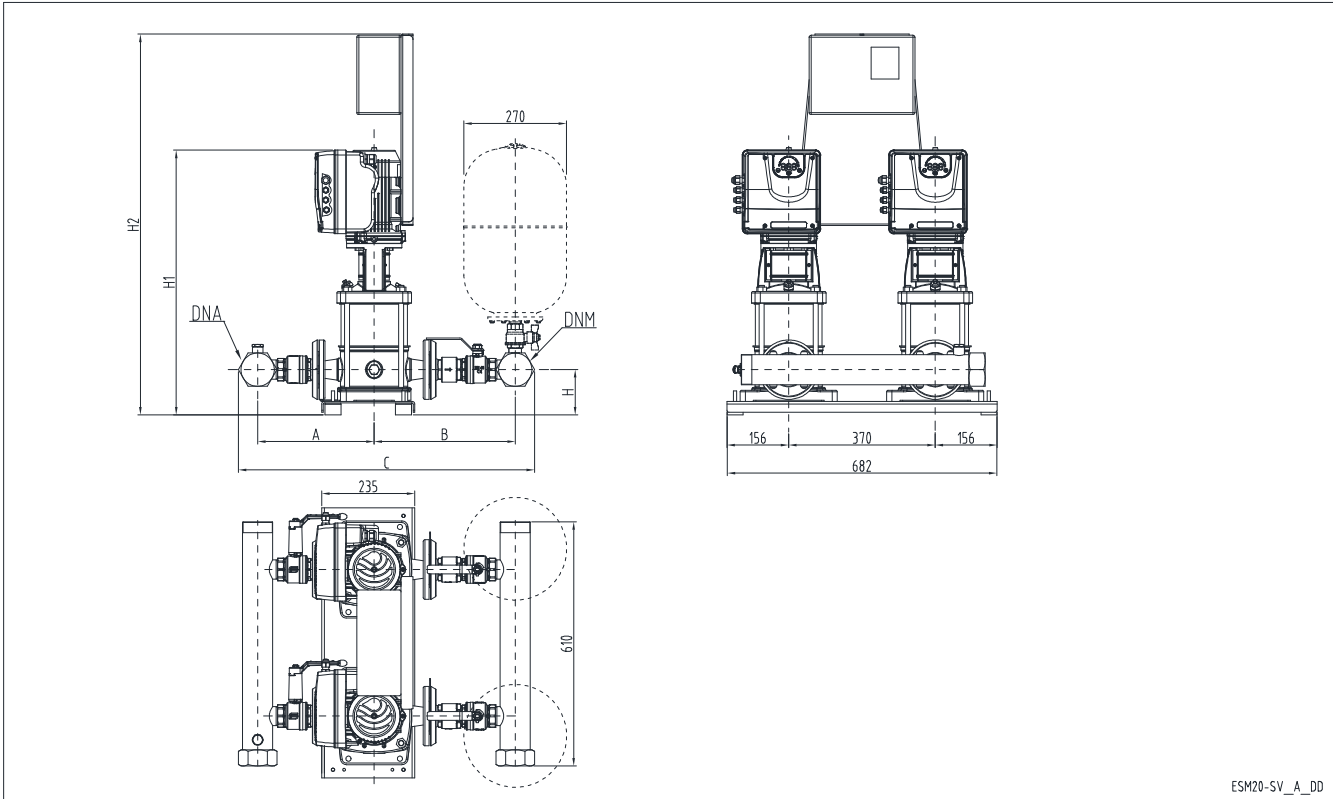

ESM20-SV_A_DD

PLEASE NOTE:

Dimensions

mm

A	256					Weight (Include external package) On demand
B	311					
C	627					
DNA	R2"					
DNM	R2"					
H	109					
H1	694					
H2	1068					

Project	Xylect-20864013	Created by		Last update	7/17/2023
Block	SMB20/3SVE09F011/M2/UK	Created on	7/17/2023		