

SMB20/5SVE06F011/M2/UK

Technical data

Company name
Contact
Phone number
e-mail address

Operating data					
1	Nominal flow	m ³ /h	0	Fluid	Water, pure
2	Nominal head	m	0	Operating temperature t A	°C 4
3	Static head	m	0	pH-value at t A	7
4	Inlet pressure	kPa	0	Density at t A	kg/m ³ 1000
5	Env ironmental temperature	°C	20	Kin. viscosity at t A	mm ² /s 1.569
6	Av ailable system NPSH	m	0	Vapor pressure at t A	kPa 100
7	Solids		0	Altitude	m 0
8					
Pump data					
9	Pump designation			Impeller Ø	Max. mm 76
10	SMB20/5SVE06F011/M2/UK				designed mm 76
11	Design	Variable speed			Min. mm 76
12	Make			Flow	Nominal m ³ /h ()
13					Max- m ³ /h 10
14	Speed	rpm	2900		Min- m ³ /h 3.1
15				Head	Nominal m
16	Max. working pressure	kPa	657.8		at Qmax m 18.4
17	Head H(Q=0)	m	67		at Qmin m 64.9
18	Weight	kg	On demand	Shaft power	kW ()
19	Weight data include external package			Max. shaft power	kW 2.3
20				Efficiency	%
21				NPSH 3%	m
Materials					
22		Booster		Motor data	
23	Manifolds	Stainless steel, 1.4301, AISI 304		Manufacturer	Lowara Electric voltage 208 V
24	On-off valves	Nickel-plated brass		Specific design	Single phase e-SM motor
25	Non-return valves	Brass		Type	ESM90R/111 SVE Electric current 8.57 A
26	Pressure switches	Galvanized steel/AISI 301		Rated power	1.1 kW Degree of protection IP 55
27	Pressure transmitters	Stainless steel, 1.4301, AISI 304		Speed	3600 rpm Insulation class F
28	Caps/plugs/flanges	AISI 304 / 316		Frame size	90R RAL 5010
29	Fittings	AISI 304 / 316		Weight	0 kg
30	Bracket	Galvanized/painted steel			
31	Base	Painted steel			
32					
Standard options					
33	Non return valve position			Non return valve in delivery side	
34	Set certificate				
35	Material Combination			Standard materials combination	
36	Pump Test			Set without certified pumps	
37	High pressure protection			Without high pressure protection on delivery	
38	Turned Delivery Manifold			Standard	
39	Oversize Piping			Standard manifold	
40	Control Panel			Standard	
41	Protection Against Dry Running			Without protection against dry running	
42	Control Devices Oversized			Standard	
43	Delivery Side			Standard delivery	
44	Suction side			Standard suction	
45	Pressure Transmitter			Standard	
46	Control Panel Position			Standard position	
47	Electric Pump Special Seals			Standard	
48	Non-return Valve			Standard non-return valve	

SMB20/5SVE06F011/M2/UK

Performance curve

Company name
Contact
Phone number
e-mail address

Operating Data Specification

Flow 0 m³/h
Head 0 m
Static head 0 m

Hydraulic data (duty point)

Flow
Head

Impeller design

Impeller R 76 mm
Frequency 50 Hz
Speed 2900 rpm

Power datas referred to:

Water, pure [100%]; 4°C; 1000kg/m³; 1.57mm²/s
Performance according to ISO 9906:2012 – Grade 3B

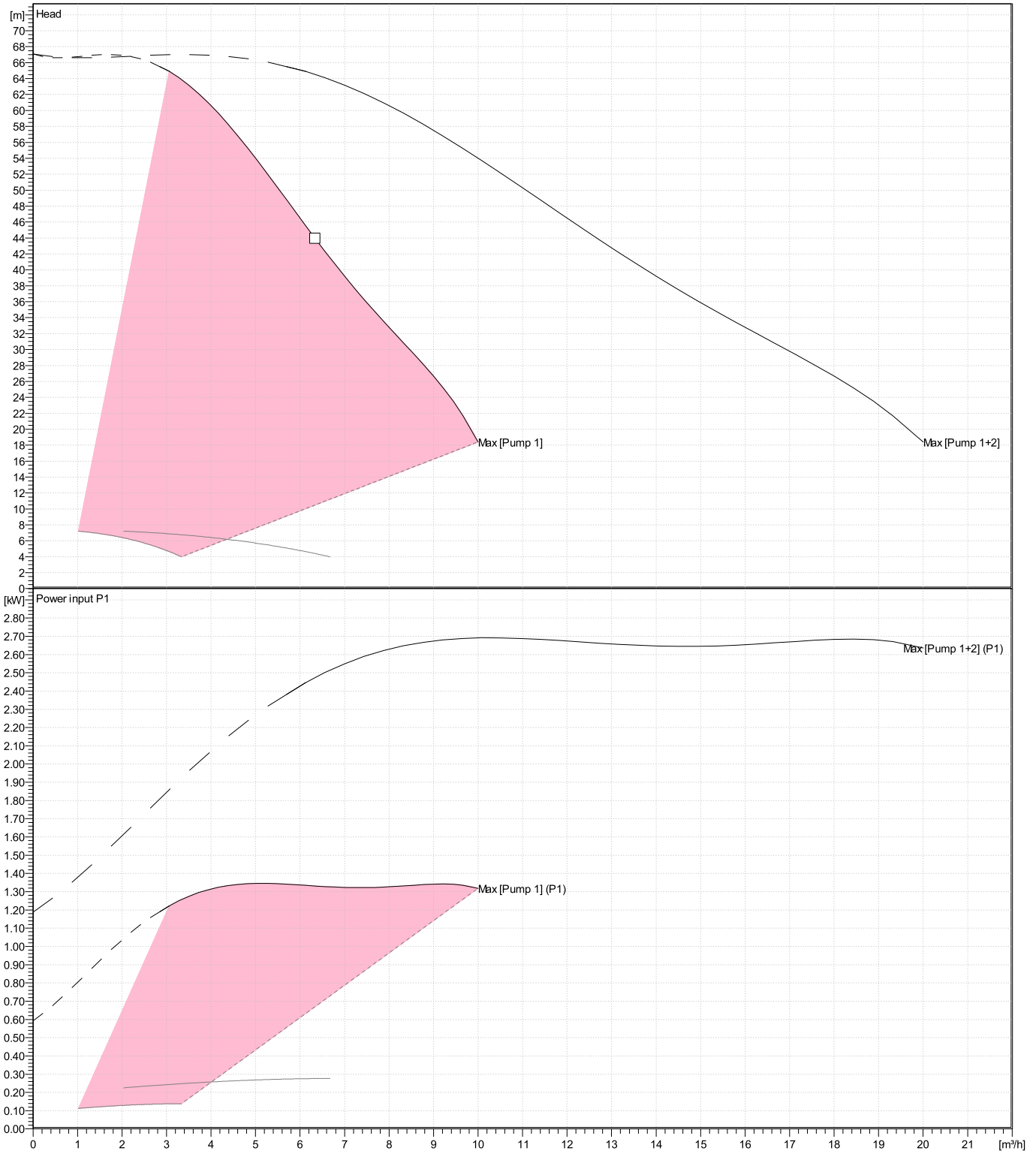

Dimensions

Company name
Contact
Phone number
e-mail address

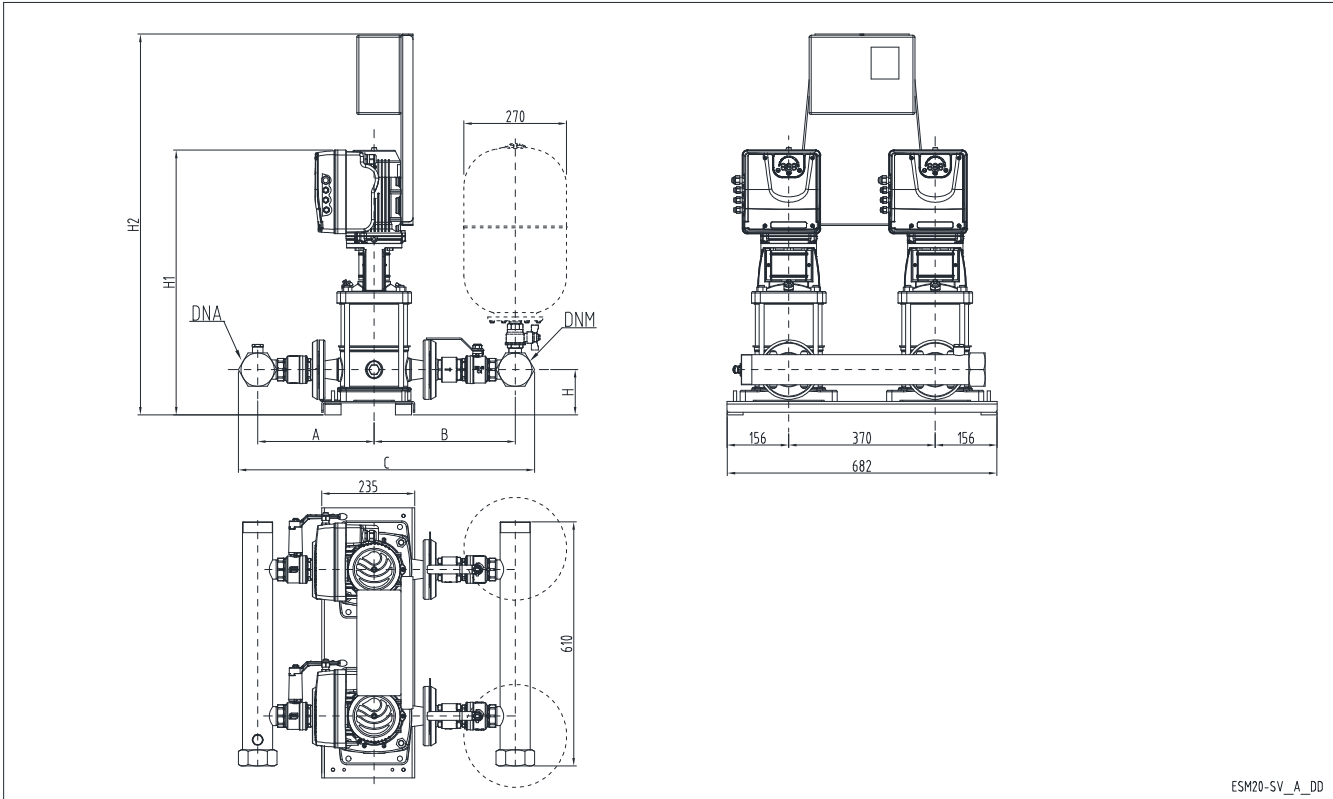

ESM20-SV_A_DD

PLEASE NOTE:

Dimensions

mm

A	260					Weight (Include external package) On demand
B	329					
C	649					
DNA	R2"					
DNM	R2"					
H	109					
H1	664					
H2	1038					

Project	Xylect-20866598	Created by		Last update	7/17/2023
Block	SMB20/5SVE06F011/M2/UK	Created on	7/17/2023		