

Position	Qty.	Description
	1	<p data-bbox="320 338 655 365">HYDRO MULTI-E 3 CRIE20-2</p> <div data-bbox="363 414 657 600" style="text-align: center;">  </div> <p data-bbox="711 611 1193 633" style="text-align: center;">Note! Product picture may differ from actual product</p> <p data-bbox="320 642 584 665">Product No.: 99133253</p> <p data-bbox="320 701 1449 754">GRUNDFOS Hydro Multi-E booster sets are designed for the transfer and pressure boosting of clean water in waterworks, blocks of flats, hotels, industry, hospitals, schools, etc.</p> <p data-bbox="320 759 1449 813">GRUNDFOS Hydro Multi-E booster set consists of 2 to 4 CRIE pumps coupled in parallel and mounted on a common base frame provided with all the necessary fittings.</p> <p data-bbox="320 848 1449 1001">Hydro Multi-E is mounted on a common base frame made of stainless steel (DIN W.-Nr. 1.4301). On the suction side are fitted a suction manifold (DIN W.-Nr. 1.4401 or DIN W.-Nr. 1.4571) , a pressure switch mounted on a drainable valve and an isolating valve. On the discharge side of the pumps are fitted a non-return valve, an isolating valve, a pressure gauge, two pressure transmitters mounted on a drainable valve a diaphragm tank and a stainless steel discharge manifold (DIN W.-Nr. 1.4401 or DIN W.-Nr. 1.4571).</p> <p data-bbox="320 1016 1086 1043">The Hydro Multi-E is fitted with an on/off-switch for the supply voltage.</p> <p data-bbox="320 1079 1398 1126">The Hydro Multi-E is designed for maintaining a constant pressure regardless of flow changes and fluctuation.</p> <p data-bbox="320 1164 1345 1216">The internal PI-controller regulates the number of running pumps and the speed of the pumps according to the required flow.</p> <p data-bbox="320 1252 1457 1303">The system can be operated directly on the panel of any of the pumps or via Grundfos GO (available as accessory)</p> <p data-bbox="320 1339 979 1606">Besides the system features: 2 Digital outputs 2 Digital inputs (one used for dry run protection) 2 Analogue inputs (one used for discharge pressure sensor) Multi-Master functionality 2 Limit functions Set-point influence function Pipe filling function High efficient PM motors</p> <p data-bbox="320 1637 708 1664">Available communication protocols:</p> <ul data-bbox="320 1668 523 1935" style="list-style-type: none"> •LON •Profibus •Modbus •SMS/GSM/GPRS •GRM •BACnet •BACnet IP •Modbus TCP •PROFINET <p data-bbox="320 1971 1426 1998">When delivered, the GRUNDFOS Hydro Multi-E booster set is factory tested and ready for operation.</p> <p data-bbox="320 2056 403 2083">Liquid:</p>

Position	Qty.	Description
		<p>Pumped liquid: Water Liquid temperature range: 5 .. 60 °C Liquid temperature during operation: 20 °C Density: 998.2 kg/m³</p> <p>Materials: Pump housing: Stainless steel</p> <p>Installation: Maximum operating pressure: 10 bar Maximum inlet pressure: PN 10 bar Flange standard: DIN2642 Manifold inlet: DN 100 Manifold outlet: DN 100</p> <p>Electrical data: IE Efficiency class: IE5 Power (P2) main pump: 4 kW Mains frequency: 50 Hz Rated voltage: 3 x 380-415 V Rated current: 22 A Start. method: electronically Enclosure class (IEC 34-5): IP54</p> <p>Tank: Volume of pressure tank: 33 l Diaphragm tank: Yes</p> <p>Others: Net weight: 276 kg Gross weight: 294 kg Shipping volume: 1.2 m³ Language: GB Country of origin: GB Custom tariff no.: 84137075</p>

99133253 HYDRO MULTI-E 3 CRIE20-2 50 Hz

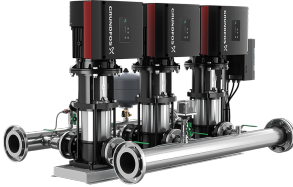
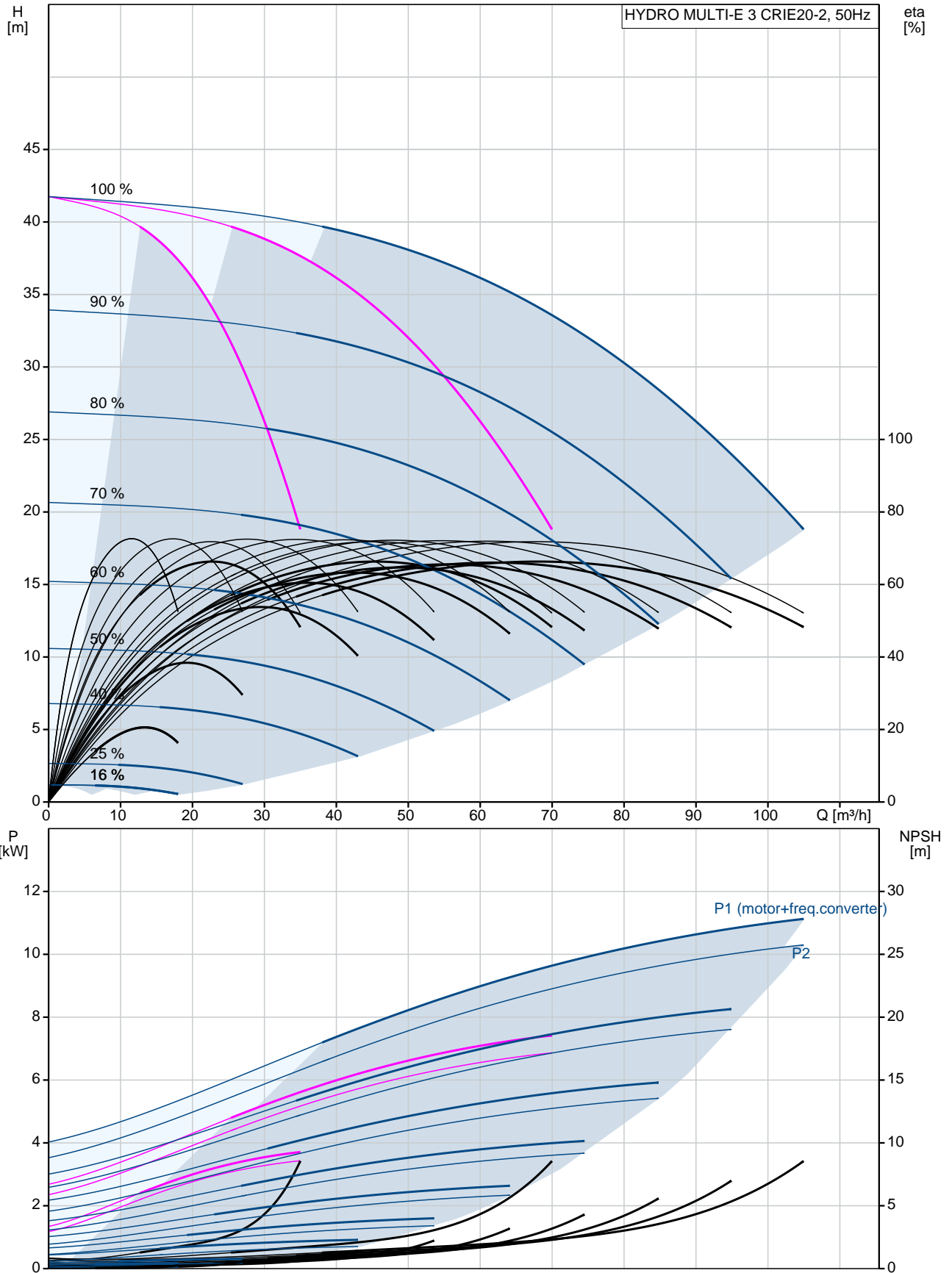

Description	Value
General information:	
Product name:	HYDRO MULTI-E 3 CRIE20-2
Product No:	99133253
EAN number:	5712607362065
Technical:	
Min flow system:	8.4 m ³ /h
Max flow:	109 m ³ /h
Head max:	42 m
Pump name:	CRIE20-2
Number of pumps:	3
Materials:	
Pump housing:	Stainless steel
Manifolds:	Stainless steel
Installation:	
Maximum operating pressure:	10 bar
Maximum inlet pressure:	PN 10 bar
Flange standard:	DIN2642
Manifold inlet:	DN 100
Manifold outlet:	DN 100
Liquid:	
Pumped liquid:	Water
Liquid temperature range:	5 .. 60 °C
Liquid temperature during operation:	20 °C
Density:	998.2 kg/m ³
Electrical data:	
IE Efficiency class:	IE5
Power (P2) main pump:	4 kW
Mains frequency:	50 Hz
Rated voltage:	3 x 380-415 V
Rated current:	22 A
Start. method:	electronically
Enclosure class (IEC 34-5):	IP54
Tank:	
Volume of pressure tank:	33 l
Diaphragm tank:	Yes
Others:	
Net weight:	276 kg
Gross weight:	294 kg
Shipping volume:	1.2 m ³
Language:	GB
Product range:	International
Country of origin:	GB
Custom tariff no.:	84137075

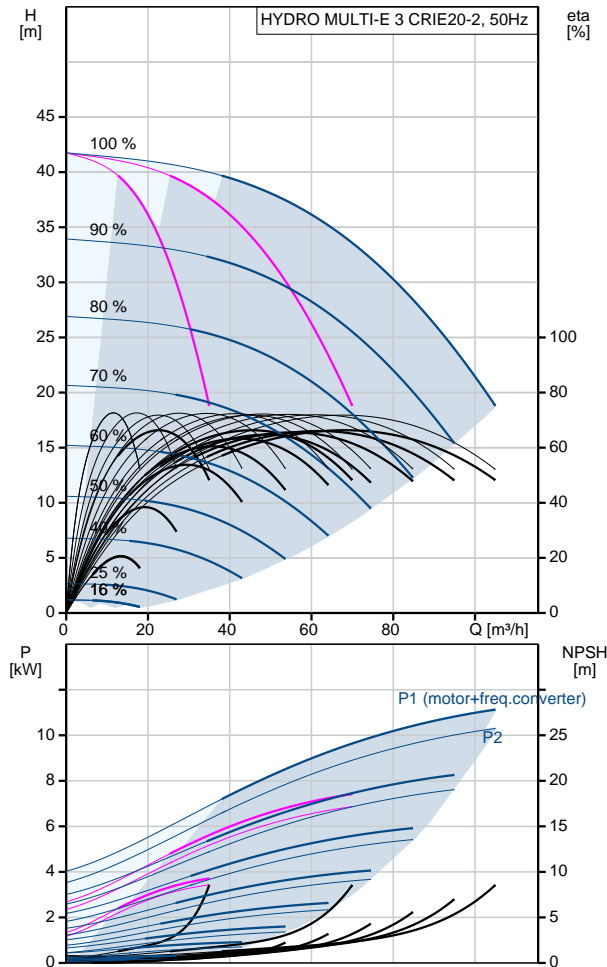

99133253 HYDRO MULTI-E 3 CRIE20-2 50 Hz

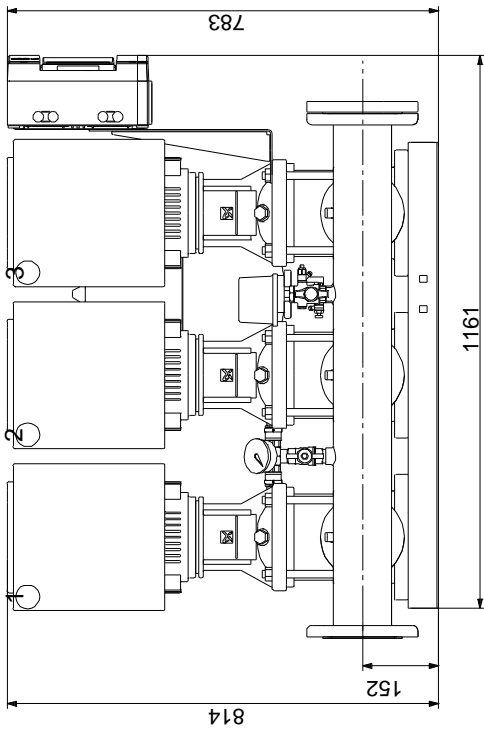
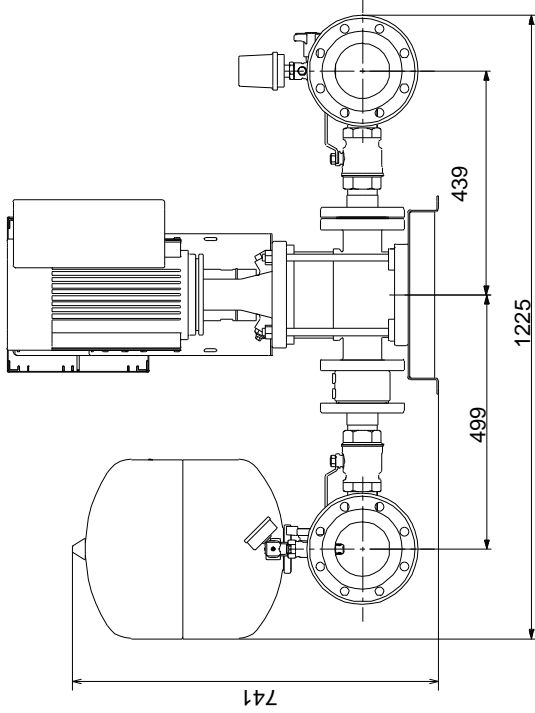

Note! All units are in [mm] unless others are stated.
Disclaimer: This simplified dimensional drawing does not show all details.

99133253 HYDRO MULTI-E 3 CRIE20-2 50 Hz

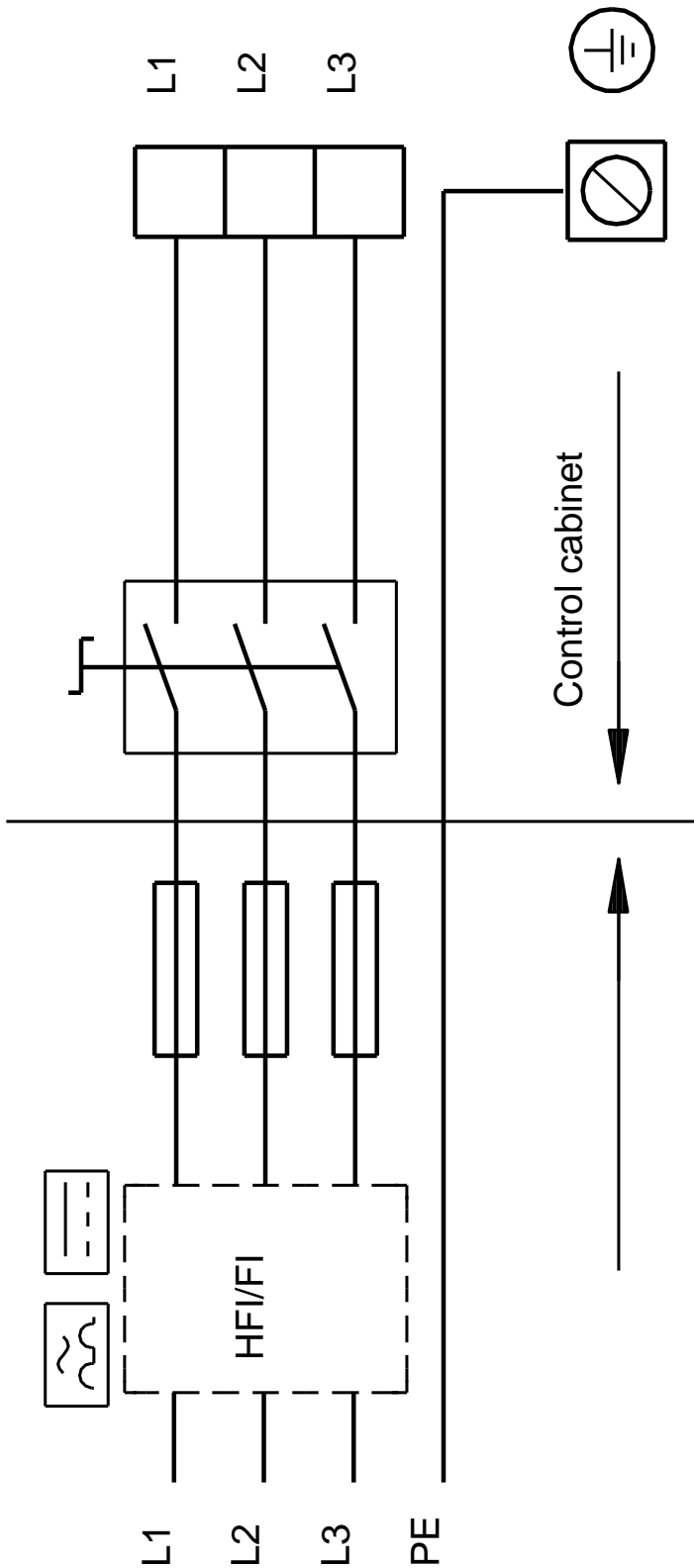

Note! All units are in [mm] unless others are stated.