

Qty. Description

1 TPE 32-580/2-S A-F-A-BQQE



Product No.: [99114657](#)

Single-stage, close-coupled, volute pump with in-line suction and discharge ports of identical diameter. The pump is of the top-pull-out design, i.e. the power head (motor, pump head and impeller) can be removed for maintenance or service while the pump housing remains in the pipework.

TPE 32-580/2-S A-F-A-BQQE The pump is fitted with an unbalanced rubber bellows seal. TPE 32-580/2-S A-F-A-BQQE The shaft seal is according to EN 12756. Pipework connection is via PN 16 DIN flanges (EN 1092-2 and ISO 7005-2).

Pipework connection is via PN 16 DIN flanges (EN 1092-2 and ISO 7005-2).

The pump is fitted with a fan-cooled, permanent-magnet synchronous motor. The motor efficiency is classified as IE5 in accordance with IEC 60034-30-2.

The motor includes a frequency converter and PI controller in the motor terminal box. This enables continuously variable control of the motor speed, which again enables adaptation of the performance to a given requirement.

The pump is fitted with a differential-pressure sensor.

Further product details

The pump is suitable for applications requiring pressure control. The pump is fitted with a differential-pressure transmitter registering the differential pressure across the pump and enabling constant pressure or proportional-pressure control of the pump.

A control panel enables setting of required setpoint as well as setting of pump to "Min." or "Max." operation or to "Stop". The control panel has indicator lights for "Operation" and "Fault".

Communication with the pump is possible by means of the Grundfos GO Remote (accessory). The remote control enables further settings as well as reading out of a number of parameters such as "Actual value", "Speed", "Power input" and total "Power consumption".

Pump

Pump housing and pump head are electrocoated to improve the corrosion resistance.

Electrocoating includes:

- 1) Alkaline-based cleaning.
- 2) Pretreatment with zinc phosphate coating.
- 3) Cathodic electrocoating (epoxy).
- 4) Curing of paint film at 200-250 °C.

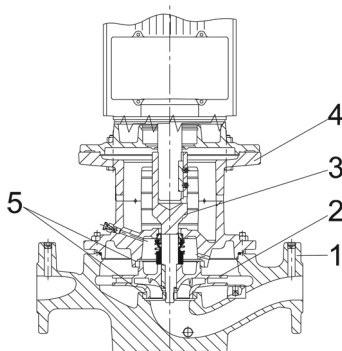

1: Pump housing

Qty.	Description
	<p>2: Impeller 3: Stub shaft 4: Pump head/motor stool 5: Wear rings</p> <p>The pump housing is provided with a replaceable brass neck ring to reduce the amount of liquid running from the outlet side of the impeller to the inlet side. The impeller is secured to the shaft with a nut.</p> <p>The pump is fitted with an unbalanced rubber bellows seal with torque transmission across the spring and around the bellows. Due to the bellows, the seal does not wear the shaft, and the axial movement is not prevented by deposits on the shaft.</p> <p>Primary seal:</p> <ul style="list-style-type: none"> • Rotating seal ring material: silicon carbide (SiC) • Stationary seat material: silicon carbide (SiC) <p>This material pairing is used where higher corrosion resistance is required. The high hardness of this material pairing offers good resistance against abrasive particles.</p> <p>Secondary seal material: EPDM (ethylene-propylene rubber) EPDM has excellent resistance to hot water. EPDM is not suitable for mineral oils.</p> <p>A circulation of liquid through the duct of the air vent screw ensures lubrication and cooling of the shaft seal. The flanges have tapings for mounting of pressure gauges.</p> <p>The motor stool forms connection between the pump housing and the motor, and is equipped with a manual air vent screw for venting of the pump housing and the shaft seal chamber. The sealing between motor stool and pump housing is an O-ring.</p> <p>The central part of the motor stool is provided with guards for protection against the shaft and coupling. The pump shaft is fastened directly on the motor shaft with key and set screws.</p> <p>Motor</p> <p>The motor is a totally enclosed, fan-cooled motor with principal dimensions to IEC and DIN standards. Electrical tolerances comply with IEC 60034.</p> <p>The motor is flange-mounted with free-hole flange (FF). Motor-mounting designation in accordance with IEC 60034-7: IM B 5, IM V 1 (Code I) / IM 3001, IM 3011 (Code II).</p> <p>The motor efficiency is classified as IE5 in accordance with IEC 60034-30-2. The motor requires no external motor protection. The motor control unit incorporates protection against slow- and quick-rising temperatures, e.g. constant overload and stalled conditions.</p> <p>TPE 32-580/2-S A-F-A-BQQE The terminal box holds terminals for these connections:</p> <ul style="list-style-type: none"> - one dedicated digital input - two analog inputs, 0(4)-20 mA, 0-5 V, 0-10 V, 0.5 - 3.5 V; the factory-fitted pressure sensor is connected to one of these inputs - 5 V voltage supply to potentiometer and sensor - one configurable digital input or open-collector output - Grundfos Digital Sensor input and output - 24 V voltage supply for sensors - two signal relay outputs (potential-free contacts) - GENibus connection - interface for Grundfos CIM fieldbus module. <p>TPE 32-580/2-S A-F-A-BQQE The terminal box holds terminals for these connections:</p> <ul style="list-style-type: none"> - one dedicated digital input - two analog inputs, 0(4)-20 mA, 0-5 V, 0-10 V, 0.5 - 3.5 V; the factory-fitted pressure sensor is connected to one of these inputs - 5 V voltage supply to potentiometer and sensor - one configurable digital input or open-collector output - Grundfos Digital Sensor input and output - 24 V voltage supply for sensors



Company name:

Created by:

Phone:

Date:

29/08/2019

Qty.	Description
------	-------------

	Gross weight: 103 kg
	Shipping volume: 0.383 m ³
	Danish VVS No.: 381941580

99114657 TPE 32-580/2-S A-F-A-BQQE 50 Hz

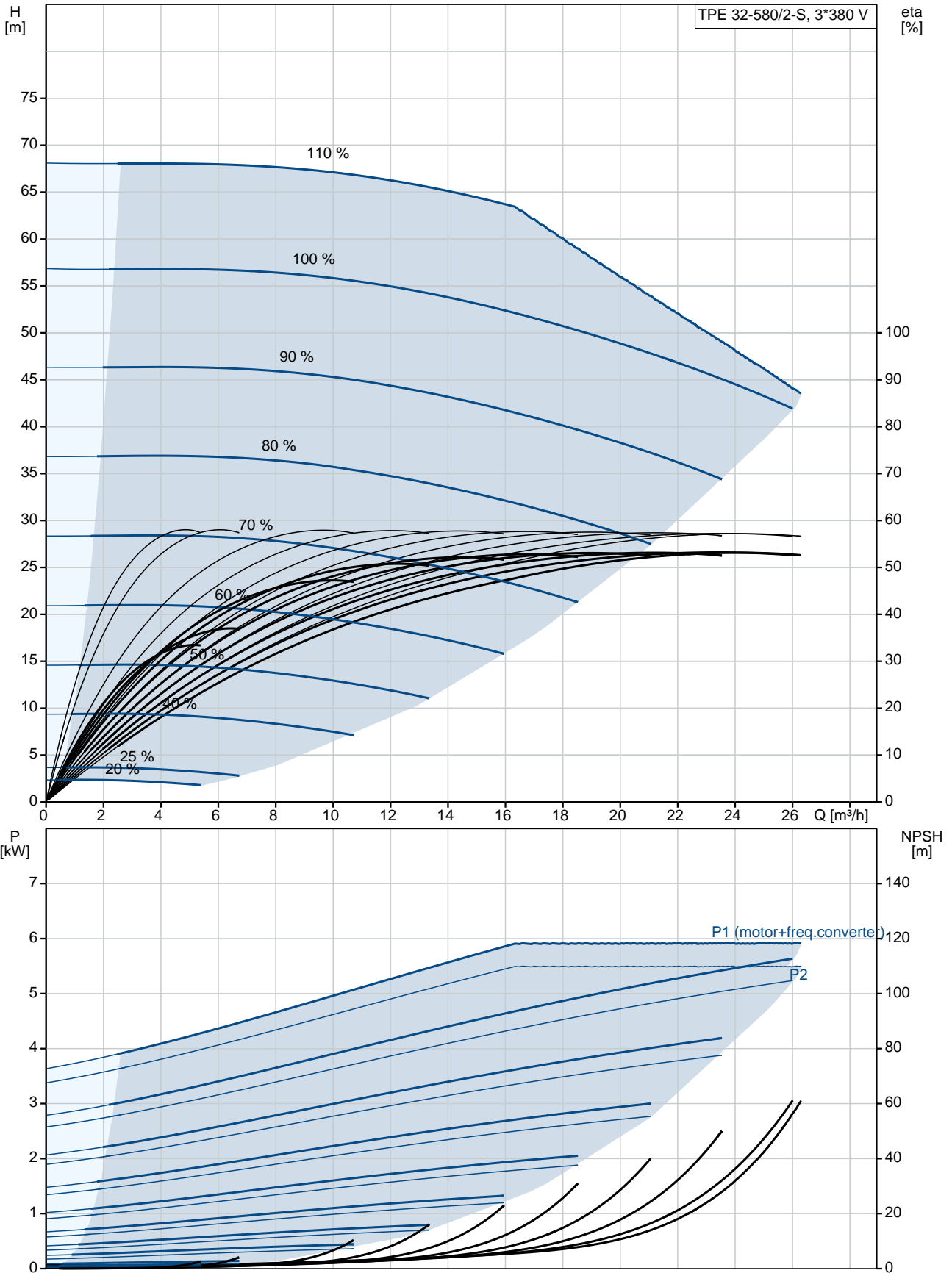



Company name:

Created by:

Phone:

Date:

29/08/2019

Description	Value
Others:	
Minimum efficiency index, MEI :	0.50
ErP status:	EuP Standalone/Prod.
Net weight:	84 kg
Gross weight:	103 kg
Shipping volume:	0.383 m ³
Config. file no:	99135879
Danish VVS No.:	381941580

99114657 TPE 32-580/2-S A-F-A-BQQE 50 Hz

