

Qty. Description

1 NBE 40-250/260 AF2ABQQE



Note! Product picture may differ from actual product

Product No.: [99105414](#)

Non-self-priming, single-stage, centrifugal volute pump designed according to ISO 5199 with dimensions and rated performance according to EN 733 (10 bar).

Flanges are PN 16 with dimensions according to EN 1092-2. The pump has an axial suction port, radial discharge port, horizontal shaft and a back pull-out design enabling removal of the motor, motor stool, cover and impeller without disturbing the pump housing or pipework.

The unbalanced rubber bellows seal is according to DIN EN 12756.

The pump is close-coupled to a fan-cooled, permanent-magnet synchronous motor.

The motor includes a frequency converter and PI controller in the motor terminal box. This enables continuously variable control of the motor speed, which again enables adaptation of the performance to a given requirement.

The product's minimum efficiency index (MEI) is greater or equal to 0.70. This is by the Commission Regulation (EU) considered as an indicative benchmark for best-performing water pump available on the market as from 1 January 2013.

An external sensor can be connected if controlled pump operation is required for flow, differential pressure or temperature control.

An operating panel on the motor terminal box enables setting of required setpoint as well as setting of pump to "Min." or "Max." operation or to "Stop". The Grundfos Eye indicator on the operating panel provides visual indication of pump status:

- "Power on": Motor is running (rotating green indicator lights) or not running (permanently green indicator lights)
- "Warning": Motor is still running (rotating yellow indicator lights) or has stopped (permanently yellow indicator lights)
- "Alarm": Motor has stopped (flashing red indicator lights).

Communication with the pump is possible by means of Grundfos GO Remote (accessory). The remote control enables further settings as well as reading out of a number of parameters such as "Actual value", "Speed", "Power input" and total "Power consumption".

The back pull-out design means that the pump can be serviced by a single person without disturbing the pump housing or pipes.

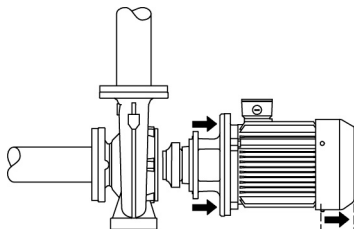

Cast-iron parts have an epoxy-based coating made in a cathodic electro-deposition (CED) process. CED is a high-quality dip-painting process where an electrical field around the products ensures deposition of paint particles as a thin, well-controlled layer on the surface.

Pump

The pump housing has both a priming and a drain hole closed by plugs. The impeller is a closed impeller with double-curved blades with smooth surfaces. The impeller is statically balanced according to ISO 1940-1 class G6.3 and hydraulically balanced to compensate for axial thrust.

Wear rings used in pump housing and for impeller are made of bronze/brass or cast iron.

Qty.	Description
	<p>Motor stool and pump cover are made of cast iron (EN-GJL-250). Coupling guards are fitted to the motor stool. The pump cover is provided with a manual air vent screw for venting of the pump housing and the shaft seal chamber.</p> <p>The pump is fitted with an unbalanced rubber bellows seal with torque transmission across the spring and around the bellows. Due to the bellows, the seal does not wear the shaft, and the axial movement is not prevented by deposits on the shaft.</p> <p>Primary seal:</p> <ul style="list-style-type: none"> • Rotating seal ring material: silicon carbide (SiC) • Stationary seat material: silicon carbide (SiC) <p>This material pairing is used where higher corrosion resistance is required. The high hardness of this material pairing offers good resistance against abrasive particles.</p> <p>Secondary seal material: EPDM (ethylene-propylene rubber) EPDM has excellent resistance to hot water. EPDM is not suitable for mineral oils. The pump housing has feet.</p> <p>Motor</p> <p>The motor is a totally enclosed, fan-cooled motor with principal dimensions to IEC and DIN standards. Electrical tolerances comply with IEC 60034.</p> <p>The motor efficiency is classified as IE5 in accordance with IEC 60034-30-2.</p> <p>The motor requires no external motor protection. The motor control unit incorporates protection against slow- and quick-rising temperatures, e.g. constant overload and stalled conditions.</p> <p>The terminal box holds terminals for these connections:</p> <ul style="list-style-type: none"> - one dedicated digital input - two analog inputs, 0(4)-20 mA, 0-5 V, 0-10 V, 0.5 - 3.5 V - 5 V voltage supply to potentiometer and sensor - one configurable digital input or open-collector output - Grundfos Digital Sensor input and output - 24 V voltage supply for sensors - two signal-relay outputs (potential-free contacts) - GENibus connection - interface for Grundfos CIM fieldbus module. <p>Further product details</p> <p>Technical data</p> <p>Controls:</p> <p>Frequency converter: Built-in</p> <p>Liquid:</p> <p>Pumped liquid: Water</p> <p>Liquid temperature range: -25 .. 120 °C</p> <p>Selected liquid temperature: 20 °C</p> <p>Density: 998.2 kg/m³</p> <p>Technical:</p> <p>Pump speed on which pump data are based: 1450 rpm</p> <p>Rated flow: 32.3 m³/h</p> <p>Rated head: 19.8 m</p> <p>Actual impeller diameter: 260 mm</p> <p>Nominal impeller diameter: 250</p> <p>Shaft seal arrangement: Single</p> <p>Code for shaft seal: BQQE</p> <p>Curve tolerance: ISO9906:2012 3B2</p> <p>Bearing design: Standard</p> <p>Materials:</p> <p>Pump housing: Cast iron EN-GJL-250 ASTM class 35</p>

Qty.	Description
	<p>Wear ring: Brass</p> <p>Impeller: Cast iron EN-GJL-200 ASTM class 30</p> <p>Shaft: Stainless steel EN 1.4301 AISI 304</p> <p>Installation:</p> <p>Maximum ambient temperature: 50 °C</p> <p>Maximum operating pressure: 16 bar</p> <p>Pipe connection standard: EN 1092-2</p> <p>Size of inlet connection: DN 65</p> <p>Size of outlet connection: DN 40</p> <p>Pipe connection standard: EN 1092-2</p> <p>Pressure rating for connection: PN 16</p> <p>Pump housing with feet: Yes</p> <p>Support block: N</p> <p>Electrical data:</p> <p>IE Efficiency class: IE5</p> <p>Rated power - P2: 3 kW</p> <p>Mains frequency: 50 Hz</p> <p>Rated voltage: 3 x 380-500 V</p> <p>Rated current: 5.80-4.60 A</p> <p>Cos phi - power factor: 0.91-0.86</p> <p>Rated speed: 180-2200 rpm</p> <p>Efficiency: 90.1%</p> <p>Motor efficiency at full load: 90.1 %</p> <p>Number of poles: 4</p> <p>Enclosure class (IEC 34-5): IP55</p> <p>Insulation class (IEC 85): F</p> <p>Motor No: 98971265</p> <p>Others:</p> <p>Minimum efficiency index, MEI η_{me}: 0.70</p> <p>Net weight: 72 kg</p> <p>Gross weight: 89 kg</p> <p>Shipping volume: 0.315 m³</p> <p>Country of origin: HU</p> <p>Custom tariff no.: 84137051</p>

99105414 NBE 40-250/260 AF2ABQQE 50 Hz

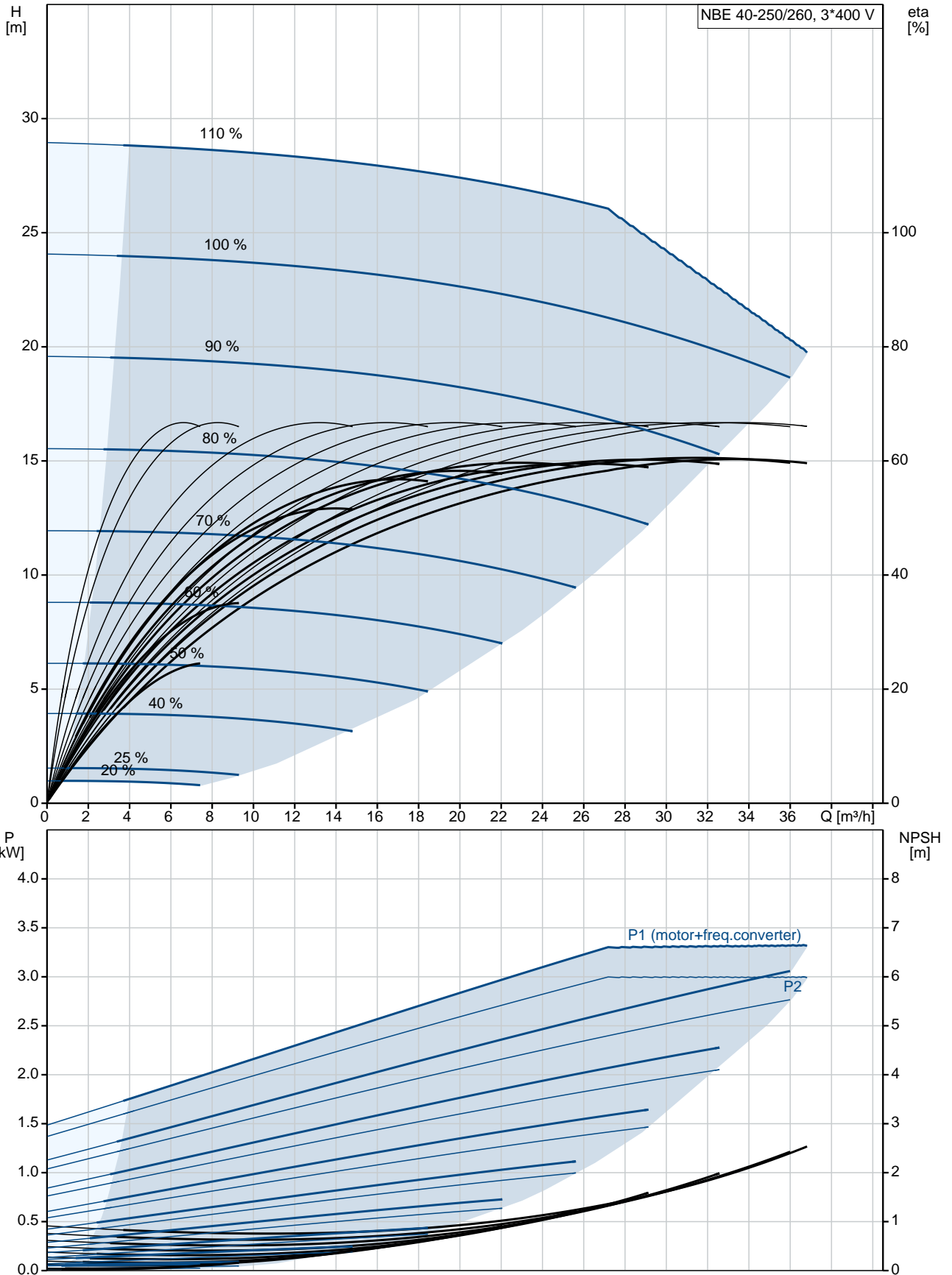

Description	Value
General information:	
Product name:	NBE 40-250/260 AF2ABQQE
Product No:	99105414
EAN number:	5712606854516
Price:	GBP 3527
Technical:	
Pump speed on which pump data are based:	1450 rpm
Rated flow:	32.3 m³/h
Rated head:	19.8 m
Actual impeller diameter:	260 mm
Nominal impeller diameter:	250
Shaft seal arrangement:	Single
Shaft diameter:	24 mm
Code for shaft seal:	BQQE
Curve tolerance:	ISO9906:2012 3B2
Pump version:	A
Bearing design:	Standard
Materials:	
Pump housing:	Cast iron
Pump housing:	EN-GJL-250
Pump housing:	ASTM class 35
Wear ring:	Brass
Impeller:	Cast iron
Impeller:	EN-GJL-200
Impeller:	ASTM class 30
Shaft:	Stainless steel
Shaft:	EN 1.4301
Shaft:	AISI 304
Material code:	A
Code for rubber:	E
Installation:	
Maximum ambient temperature:	50 °C
Maximum operating pressure:	16 bar
Pipe connection standard:	EN 1092-2
Size of inlet connection:	DN 65
Size of outlet connection:	DN 40
Pipe connection standard:	EN 1092-2
Pressure rating for connection:	PN 16
Pump housing with feet:	Yes
Support block:	N
Connect code:	F2
Liquid:	
Pumped liquid:	Water
Liquid temperature range:	-25 .. 120 °C
Selected liquid temperature:	20 °C
Density:	998.2 kg/m³
Electrical data:	
IE Efficiency class:	IE5
Rated power - P2:	3 kW
Mains frequency:	50 Hz
Rated voltage:	3 x 380-500 V
Rated current:	5.80-4.60 A
Cos phi - power factor:	0.91-0.86
Rated speed:	180-2200 rpm
Efficiency:	90.1 %
Motor efficiency at full load:	90.1 %
Number of poles:	4

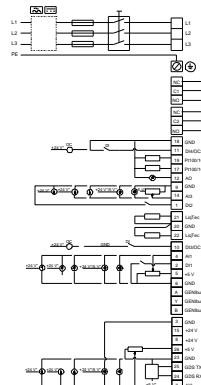
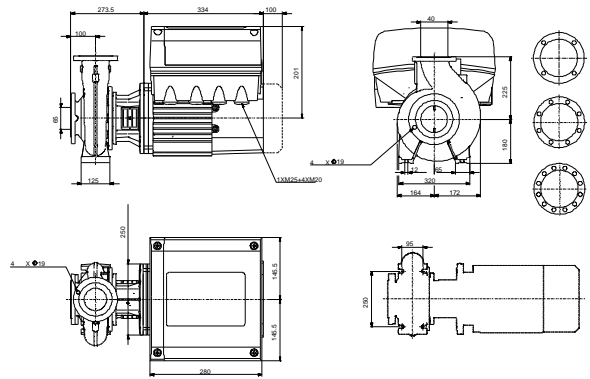
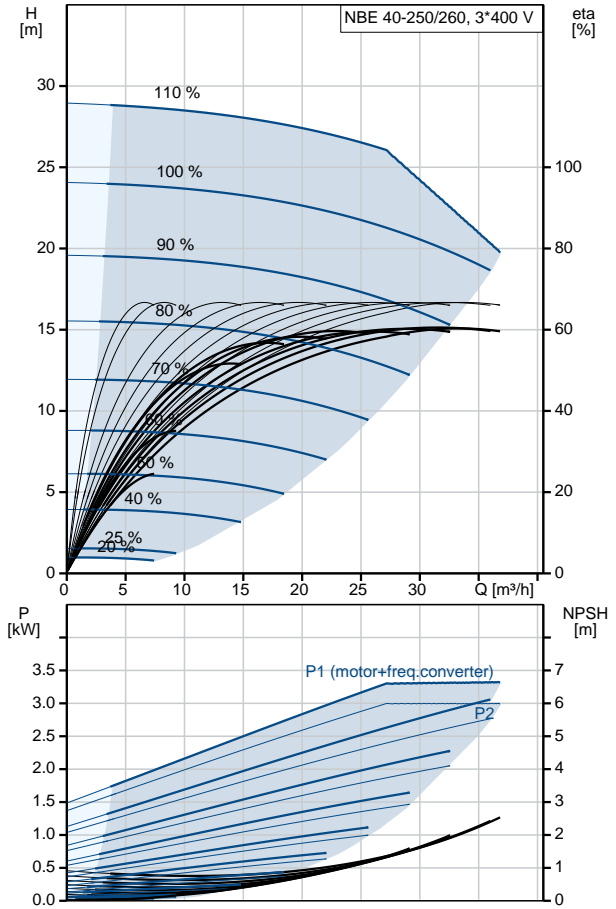



Company name:

Created by:

Phone:

Date:

29/10/2020

Description	Value
Enclosure class (IEC 34-5):	IP55
Insulation class (IEC 85):	F
Motor protec:	ELEC
Motor No:	98971265
Mount. design. acc. IEC 34-7:	IM V1/B5
Controls:	
Control panel:	HMI300 - Advanced
Function Module:	FM300 - Advanced
Frequency converter:	Built-in
Others:	
Minimum efficiency index, MEI %:	0.70
Net weight:	72 kg
Gross weight:	89 kg
Shipping volume:	0.315 m ³
Country of origin:	HU
Custom tariff no.:	84137051

99105414 NBE 40-250/260 AF2ABQQE 50 Hz

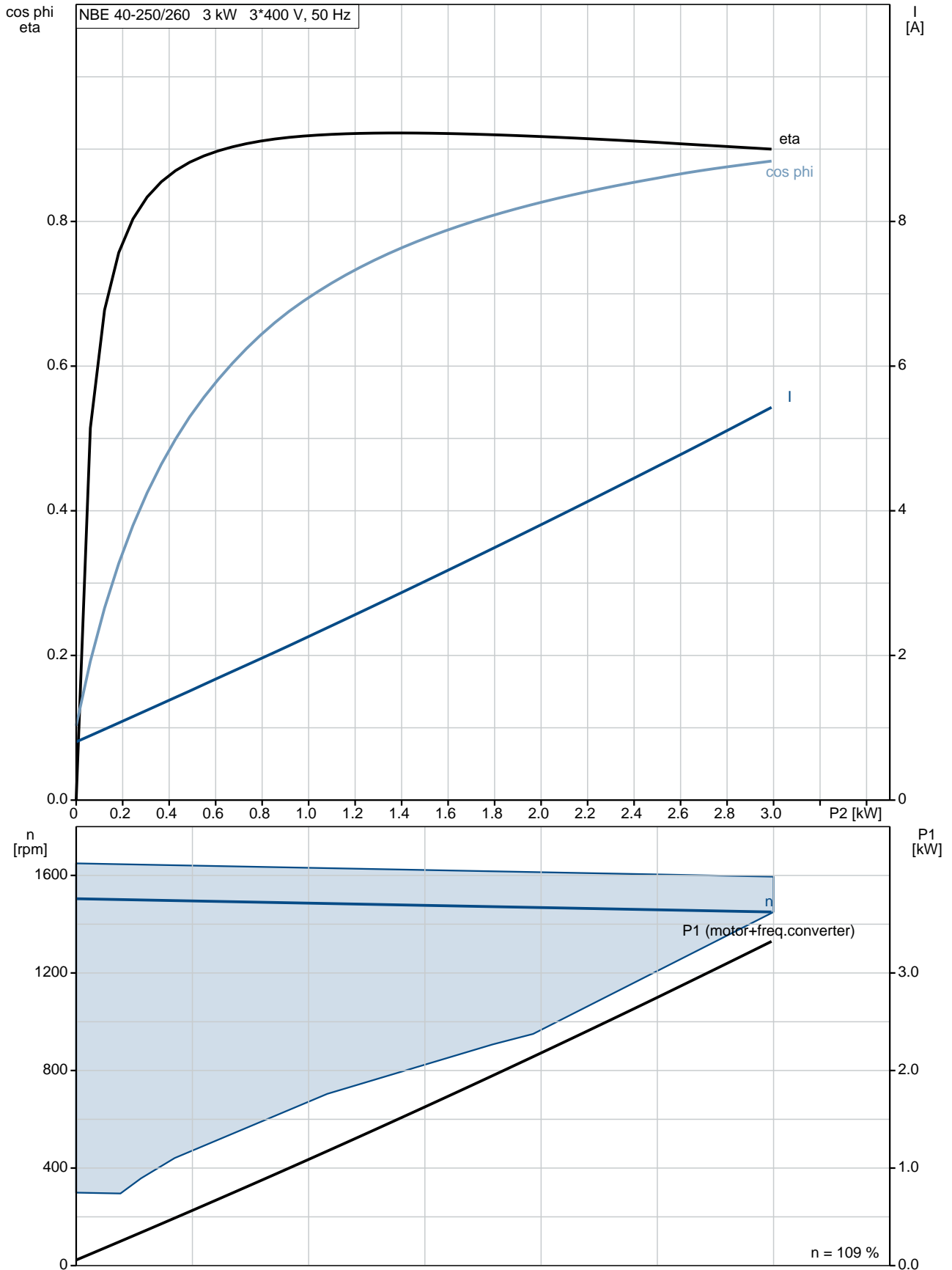

99105414 NBE 40-250/260 AF2ABQQE 50 Hz

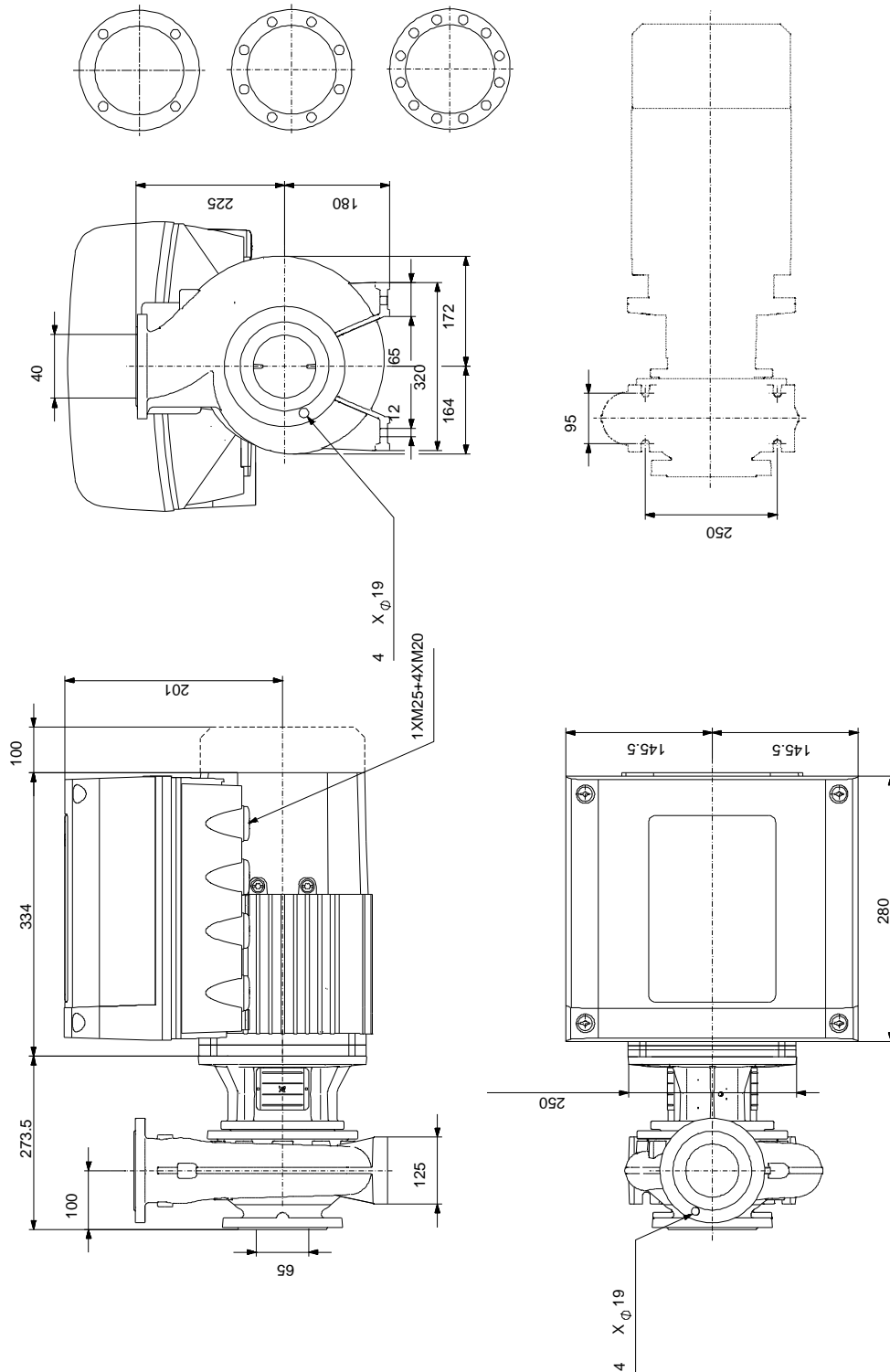

Note! All units are in [mm] unless others are stated.
 Disclaimer: This simplified dimensional drawing does not show all details.

99105414 NBE 40-250/260 AF2ABQQE 50 Hz

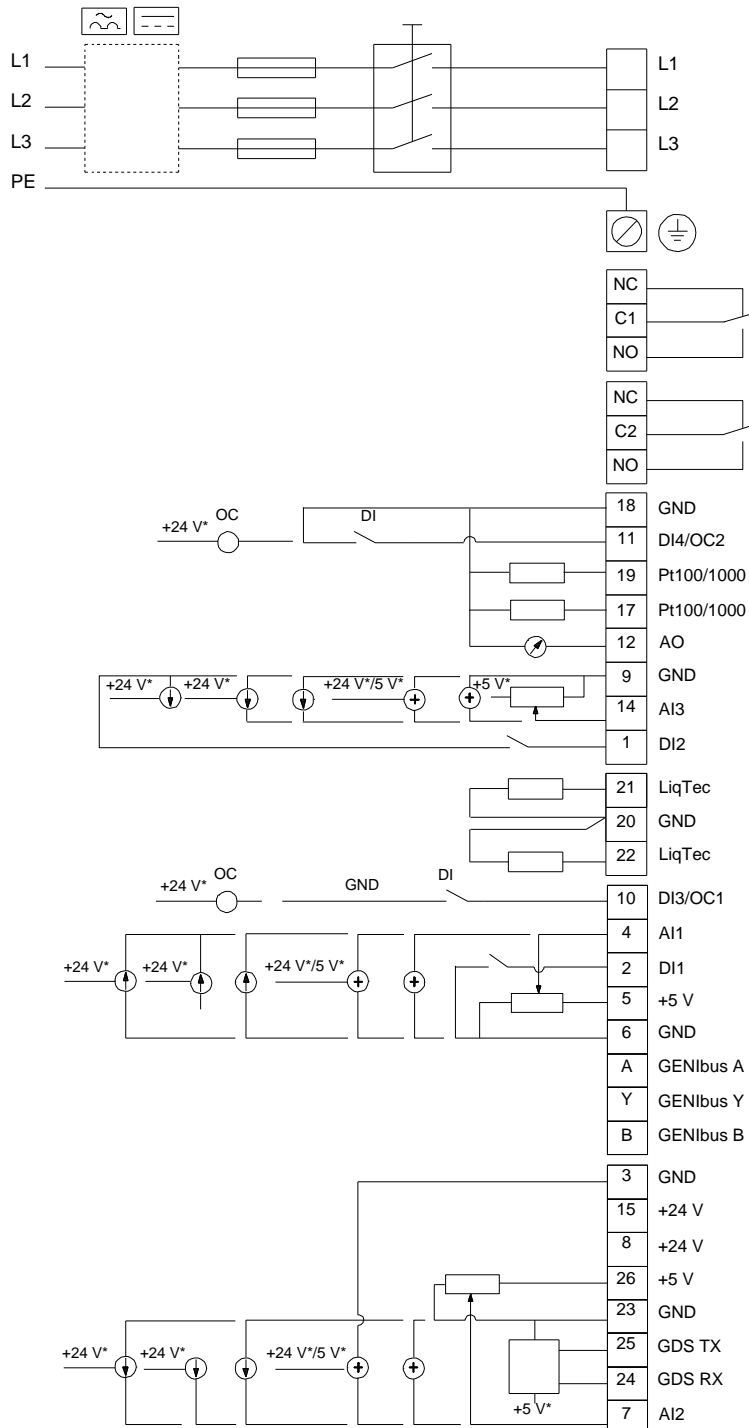

Note! All units are in [mm] unless others are stated.