

Qty. Description

1 **NBE 40-160/144AF2ABQQE**



Note! Product picture may differ from actual product

Product No.: [99101966](#)

Non-self-priming, single-stage, centrifugal volute pump designed according to ISO 5199 with dimensions and rated performance according to EN 733 (10 bar).

Flanges are PN 16 with dimensions according to EN 1092-2. The pump has an axial suction port, radial discharge port, horizontal shaft and a back pull-out design enabling removal of the motor, motor stool, cover and impeller without disturbing the pump housing or pipework.

The unbalanced rubber bellows seal is according to DIN EN 12756.

The pump is close-coupled to a fan-cooled, permanent-magnet synchronous motor.

The motor includes a frequency converter and PI controller in the motor terminal box. This enables continuously variable control of the motor speed, which again enables adaptation of the performance to a given requirement.

Controls:

Frequency converter: Built-in

Liquid:

Pumped liquid: Water
 Liquid temperature range: -25 .. 120 °C
 Selected liquid temperature: 20 °C
 Density at selected liquid temperature: 998.2 kg/m³

Technical:

Pump speed on which pump data are based: 2901 rpm
 Rated flow: 39 m³/h
 Rated head: 23.42 m
 Actual impeller diameter: 144 mm
 Nominal impeller diameter: 160 mm
 Shaft seal arrangement: Single
 Code for shaft seal: BQQE
 Curve tolerance: ISO9906:2012 3B

Materials:

Pump housing: Cast iron
 EN-GJL-250
 ASTM class 35
 Wear ring: Brass
 Impeller: Cast iron
 EN-GJL-200
 ASTM class 30
 Shaft: Stainless steel
 EN 1.4301
 AISI 304

Installation:

Maximum ambient temperature: 50 °C
 Maximum operating pressure: 16 bar
 Pipe connection standard: EN 1092-2
 Size of inlet connection: DN 65

Qty.	Description
	<p>Size of outlet connection: DN 40 Pressure rating for pipe connection: PN 16 Pump housing with feet: Y Support block: N</p> <p>Electrical data: IE Efficiency class: IE5 P2: 4 kW Mains frequency: 50 Hz Rated voltage: 3 x 380-500 V Rated current: 7.60-6.20 A Cos phi - power factor: 0.92-0.87 Rated speed: 360-4000 rpm Efficiency: 92.2% Motor efficiency at full load: 92.2 % Enclosure class (IEC 34-5): IP55 Insulation class (IEC 85): F Motor No: 98971270</p> <p>Others: Minimum efficiency index, MEI $\hat{\alpha}\%$: 0.70 Net weight: 57 kg Gross weight: 67 kg Shipping volume: 0.178 m³ Country of origin: HU Custom tariff no.: 84137051</p>

99101966 NBE 40-160/144AF2ABQQE 50 Hz

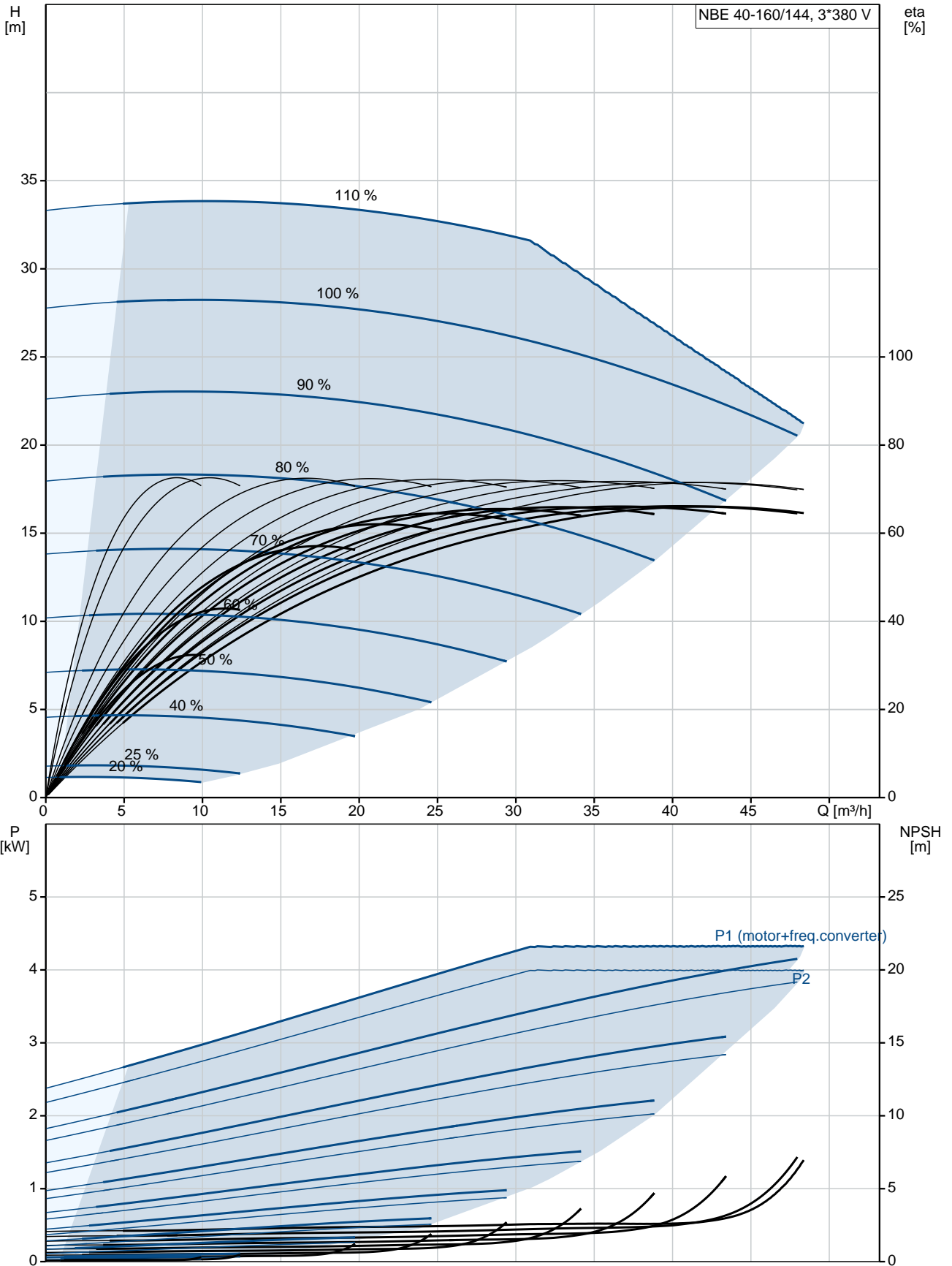

Description	Value
General information:	
Product name:	NBE 40-160/144AF2ABQQE
Product No:	99101966
EAN number:	5712606792238
Price:	3.703,00 GBP
Technical:	
Pump speed on which pump data are based:	2901 rpm
Rated flow:	39 m ³ /h
Rated head:	23.42 m
Actual impeller diameter:	144 mm
Nominal impeller diameter:	160 mm
Shaft seal arrangement:	Single
Shaft diameter:	24 mm
Code for shaft seal:	BQQE
Curve tolerance:	ISO9906:2012 3B
Pump version:	A
Materials:	
Pump housing:	Cast iron EN-GJL-250 ASTM class 35
Wear ring:	Brass
Impeller:	Cast iron EN-GJL-200 ASTM class 30
Shaft:	Stainless steel EN 1.4301 AISI 304
Material code:	A
Code for rubber:	E
Installation:	
Maximum ambient temperature:	50 °C
Maximum operating pressure:	16 bar
Pipe connection standard:	EN 1092-2
Size of inlet connection:	DN 65
Size of outlet connection:	DN 40
Pressure rating for pipe connection:	PN 16
Pump housing with feet:	Y
Support block:	N
Connect code:	F2
Liquid:	
Pumped liquid:	Water
Liquid temperature range:	-25 .. 120 °C
Selected liquid temperature:	20 °C
Density at selected liquid temperature:	998.2 kg/m ³
Electrical data:	
IE Efficiency class:	IE5
P2:	4 kW
Mains frequency:	50 Hz
Rated voltage:	3 x 380-500 V
Rated current:	7.60-6.20 A
Cos phi - power factor:	0.92-0.87
Rated speed:	360-4000 rpm
Efficiency:	92.2%
Motor efficiency at full load:	92.2 %
Enclosure class (IEC 34-5):	IP55
Insulation class (IEC 85):	F
Motor protec:	YES

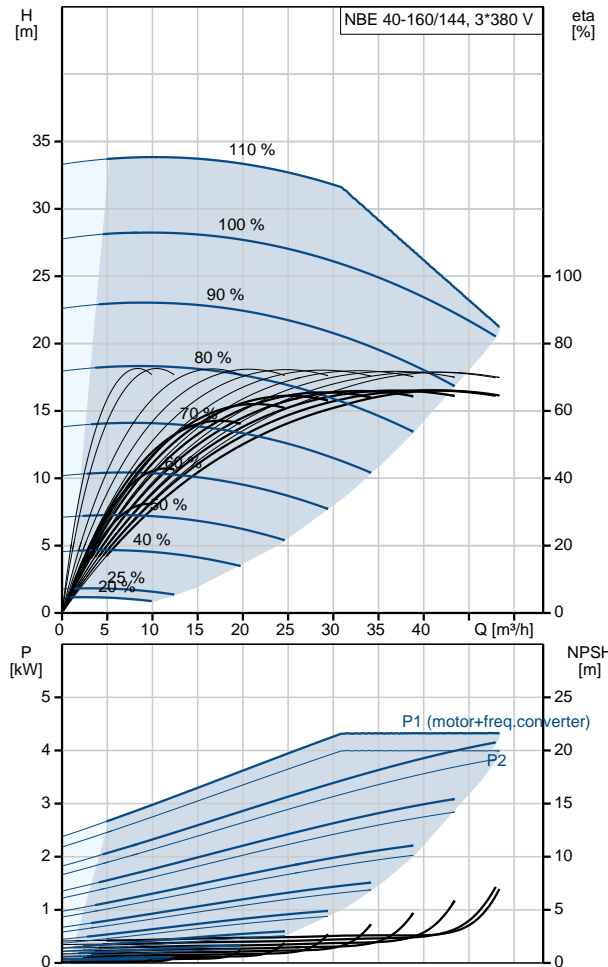



Company name:

Created by:

Phone:

Date:

16/05/2019

Description	Value
Motor No:	98971270
Mount. design. acc. IEC 34-7:	IM V1/B5
Controls:	
Control panel:	HMI300 - Advanced
Function Module:	FM300 - Advanced
Frequency converter:	Built-in
Others:	
Minimum efficiency index, MEI $\eta_{\%}$:	0.70
Net weight:	57 kg
Gross weight:	67 kg
Shipping volume:	0.178 m ³
Country of origin:	HU
Custom tariff no.:	84137051

99101966 NBE 40-160/144AF2ABQQE 50 Hz

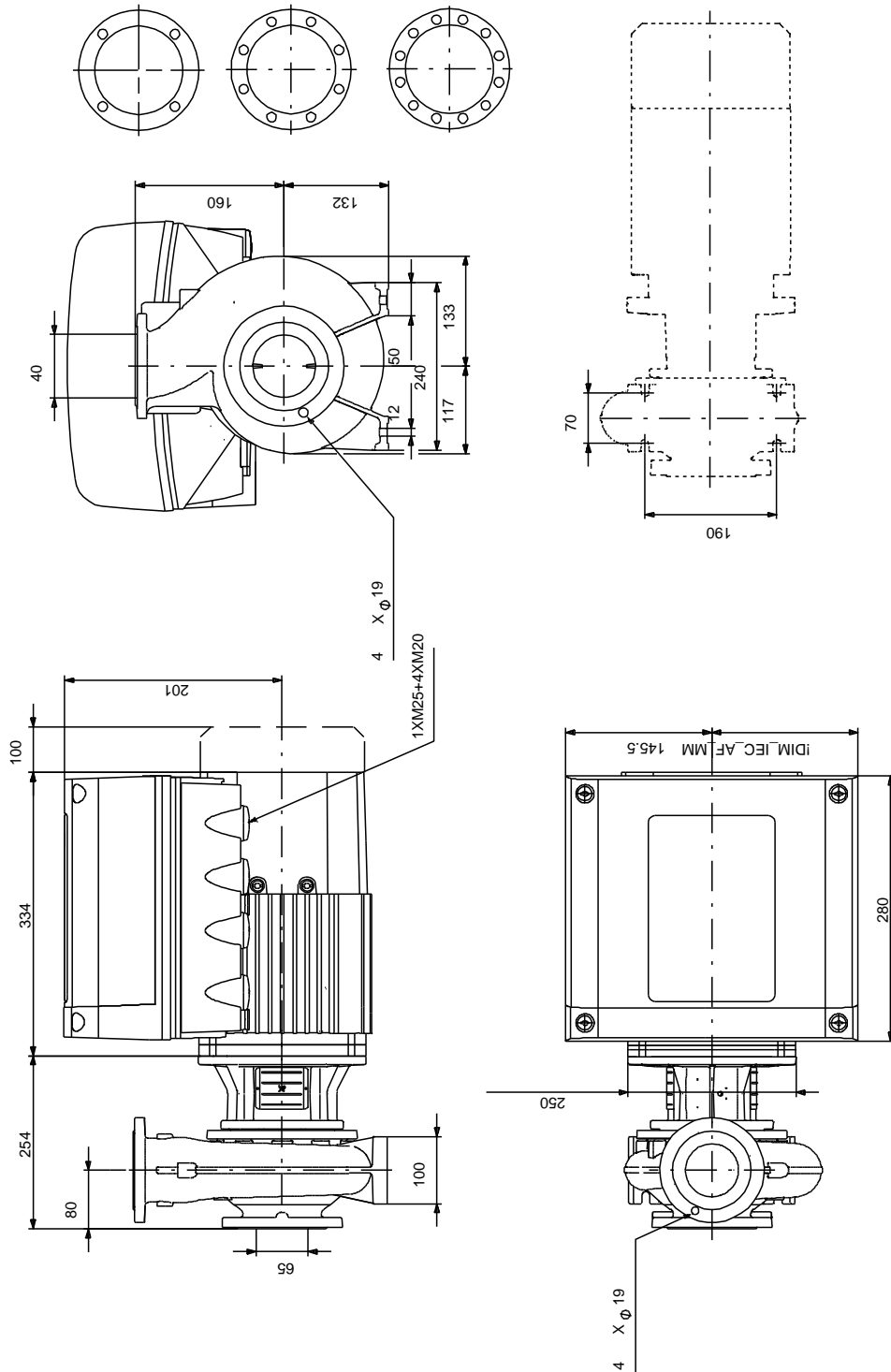

Note! All units are in [mm] unless others are stated.
 Disclaimer: This simplified dimensional drawing does not show all details.

99101966 NBE 40-160/144AF2ABQQE 50 Hz

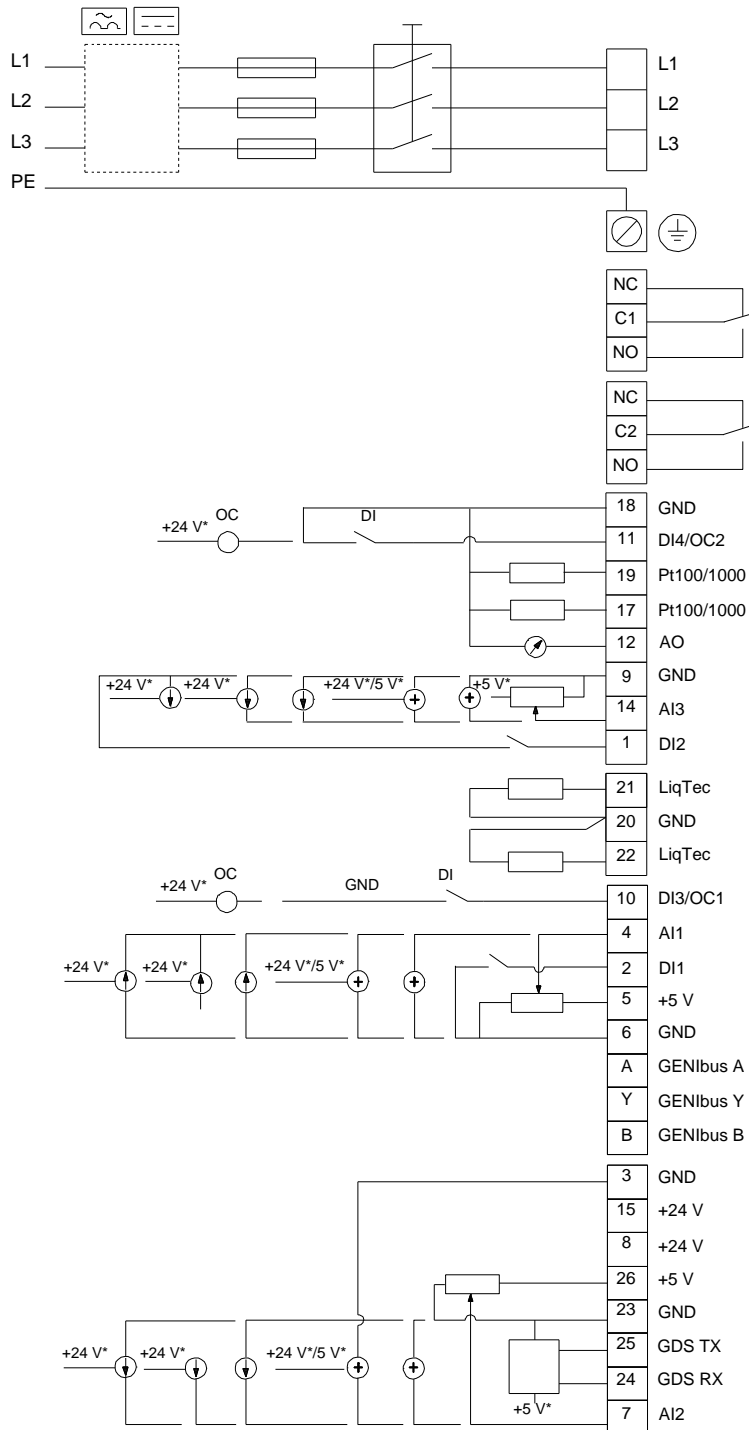

Note! All units are in [mm] unless others are stated.