

Qty. Description

1 CRNE 64-1-1 A-F-A-E-HQQE



Note! Product picture may differ from actual product

Product No.: [99072078](#)

Vertical, multistage centrifugal pump with inlet and outlet ports on same the level (inline). Pump materials in contact with the liquid are in high-grade stainless steel. A cartridge shaft seal ensures high reliability, safe handling, and easy access and service. Power transmission is via a rigid split coupling. Pipe connection is via DIN flanges.

The pump is fitted with a 3-phase, fan-cooled, permanent-magnet, synchronous motor.

The motor efficiency is classified as IE5 in accordance with IEC 60034-30-2.

The motor includes a frequency converter and PI controller in the motor terminal box. This enables continuously variable control of the motor speed, which again enables adaptation of the performance to a given requirement.

An operating panel on the motor terminal box enables setting of required setpoint as well as setting of pump to "Min." or "Max." operation or to "Stop". The Grundfos Eye indicator on the operating panel provides visual indication of pump status:

- "Power on": Motor is running (rotating green indicator lights) or not running (permanently green indicator lights)
- "Warning": Motor is still running (rotating yellow indicator lights) or has stopped (permanently yellow indicator lights)
- "Alarm": Motor has stopped (flashing red indicator lights).

Communication with the pump is possible by means of Grundfos GO Remote (accessory). The remote control enables further settings as well as reading out of a number of parameters such as "Actual value", "Speed", "Power input" and total "Power consumption".

The terminal box has a number of inputs and outputs enabling the motor to be used in advanced applications where many inputs and outputs are required:

- two dedicated digital inputs
- three analog inputs, 0(4)-20 mA, 0-5 V, 0-10 V, 0.5 - 3.5 V
- 5 V voltage supply to potentiometer and sensor
- one analog output, 0-10 V, 0(4)-20 mA
- two configurable digital inputs or open-collector outputs
- two Pt100/Pt1000 inputs
- LiqTec, dry-running protection sensor input
- Grundfos Digital Sensor input and output
- 24 V voltage supply for sensors
- two signal-relay outputs (potential-free contacts)
- GENibus connection
- interface for Grundfos CIM fieldbus module.

Further product details

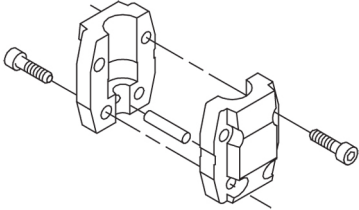
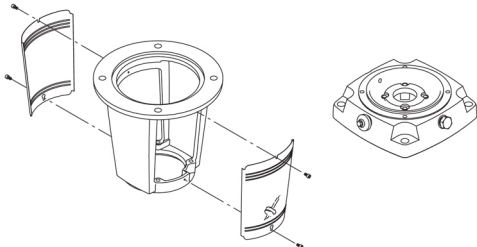
Qty.	Description
	<p>An external sensor can be connected if controlled pump operation based on for example flow, differential pressure or temperature is required.</p> <p>An operating panel on the motor terminal box enables setting of required setpoint as well as setting of pump to "Min." or "Max." operation or to "Stop". The Grundfos Eye indicator on the operating panel provides visual indication of pump status:</p> <ul style="list-style-type: none"> • "Power on": Motor is running (rotating green indicator lights) or not running (permanently green indicator lights) • "Warning": Motor is still running (rotating yellow indicator lights) or has stopped (permanently yellow indicator lights) • "Alarm": Motor has stopped (flashing red indicator lights). <p>Communication with the pump is possible by means of Grundfos GO Remote (accessory). The remote control enables further settings as well as reading out of a number of parameters such as "Actual value", "Speed", "Power input" and total "Power consumption".</p> <p>Steel, cast iron and aluminium components have an epoxy-based coating made in a cathodic electro-deposition (CED) process. CED is a high-quality dip-painting process where an electrical field around the products ensures deposition of paint particles as a thin, well-controlled layer on the surface. An integral part of the process is a pretreatment. The entire process consists of these elements:</p> <ol style="list-style-type: none"> 1) Alkaline-based cleaning. 2) Zinc phosphating. 3) Cathodic electro-deposition. 4) Curing to a dry film thickness 18-22 my m. <p>The colour code for the finished product is NCS 9000/RAL 9005.</p> <p>Pump</p> <p>A standard split coupling connects the pump and motor shaft. It is enclosed in the pump head/motor stool by means of two coupling guards.</p>  <p>The motor stool connects the pump head and motor. The pump head has a combined 1/2" priming plug and vent screw.</p>  <p>The pump is fitted with a balanced O-ring seal unit with a rigid torque-transmission system. This seal type is assembled in a cartridge unit which makes replacement safe and easy. Due to the balancing, this seal type is suitable for high-pressure applications. The cartridge construction also protects the pump shaft from possible wear from a dynamic O-ring between pump shaft and shaft seal.</p> <p>Primary seal:</p> <ul style="list-style-type: none"> • Rotating seal ring material: silicon carbide (SiC) • Stationary seat material: silicon carbide (SiC) <p>This material pairing is used where higher corrosion resistance is required. The high hardness of this material pairing offers good resistance against abrasive particles.</p> <p>Secondary seal material: EPDM (ethylene-propylene rubber)</p> <p>EPDM has excellent resistance to hot water. EPDM is not suitable for mineral oils.</p>

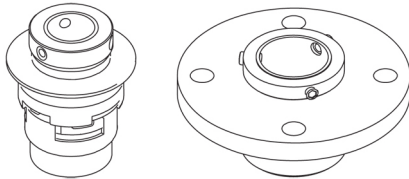

The shaft seal is retained in the pump head by a cover and screws. It can be replaced without removing the motor.

The pump has a special air-cooled shaft-seal chamber generating the same insulation effect as that of a vacuum flask. No external cooling is necessary; the ambient temperature is sufficient. An automatic vent vents the pump seal chamber.

The chambers and impellers are made of stainless-steel sheet. The chambers are provided with a PTFE neck ring offering improved sealing and high efficiency. The impellers have smooth surfaces, and the shape of the blades ensure a high efficiency.

The pump has a stainless-steel base mounted on a separate base plate. The base and base plate are kept in position by the tension of the staybolts which hold the pump together. Both the inlet and the outlet side of the base have two pressure gauge tapings. The pump is secured to the foundation by four bolts through the base plate. The flanges are fastened to the base by means of locking rings.

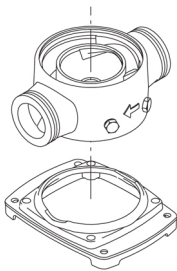

Motor

The motor is a totally enclosed, fan-cooled motor with principal dimensions to IEC and DIN standards. Electrical tolerances comply with IEC 60034.

The motor efficiency is classified as IE5 in accordance with IEC 60034-30-2.

The motor requires no external motor protection. The motor control unit incorporates protection against slow- and quick-rising temperatures, e.g. constant overload and stalled conditions.

The terminal box has a number of inputs and outputs enabling the motor to be used in advanced applications where many inputs and outputs are required:

- two dedicated digital inputs
- three analog inputs, 0(4)-20 mA, 0-5 V, 0-10 V, 0.5 - 3.5 V
- 5 V voltage supply to potentiometer and sensor
- one analog output, 0-10 V, 0(4)-20 mA
- two configurable digital inputs or open-collector outputs
- two Pt100/Pt1000 inputs
- LiqTec, dry-running protection sensor input
- Grundfos Digital Sensor input and output
- 24 V voltage supply for sensors
- two signal-relay outputs (potential-free contacts)
- GENibus connection
- interface for Grundfos CIM fieldbus module.

Technical data

Controls:

Frequency converter:	Built-in
Pressure sensor:	No

Qty.	Description
	<p>Liquid: Pumped liquid: Water Liquid temperature range: -40 .. 120 °C Selected liquid temperature: 20 °C Density at selected liquid temperature: 998.2 kg/m³</p> <p>Technical: Pump speed on which pump data are based: 3525 rpm Rated flow: 77 m³/h Rated head: 20.8 m Pump orientation: Vertical Shaft seal arrangement: Single Code for shaft seal: HQQE Approvals on nameplate: CE, EAC, ACS Curve tolerance: ISO9906:2012 3B</p> <p>Materials: Base: Stainless steel EN 1.4408 AISI 316 Impeller: Stainless steel EN 1.4401 AISI 316 Bearing: SIC Support bearing: Graflon</p> <p>Installation: Maximum ambient temperature: 50 °C Maximum operating pressure: 16 bar Max pressure at stated temp: 16 bar / 120 °C 16 bar / -40 °C Type of connection: DIN Size of inlet connection: DN 100 Size of outlet connection: DN 100 Pressure rating for pipe connection: PN 16 Flange size for motor: FF265</p> <p>Electrical data: Motor standard: IEC Motor type: 132SF IE Efficiency class: IE5 Rated power - P2: 7.5 kW Power (P2) required by pump: 7.5 kW Mains frequency: 50 Hz Rated voltage: 3 x 380-500 V Rated current: 14.1-11.2 A Cos phi - power factor: 0.93-0.89 Rated speed: 360-4000 rpm Efficiency: 92.5% Motor efficiency at full load: 92.5 % Enclosure class (IEC 34-5): IP55 Insulation class (IEC 85): F Motor No: 98971052</p> <p>Others: Minimum efficiency index, MEI : 0.70 Net weight: 107 kg Gross weight: 140 kg Shipping volume: 0.495 m³</p>



Company name:

Created by:

Phone:

Date:

26/11/2019

Qty.	Description
------	-------------

	Danish VVS No.: 386022061
	Country of origin: GB
	Custom tariff no.: 84137075

99072078 CRNE 64-1-1 A-F-A-E-HQQE 50 Hz

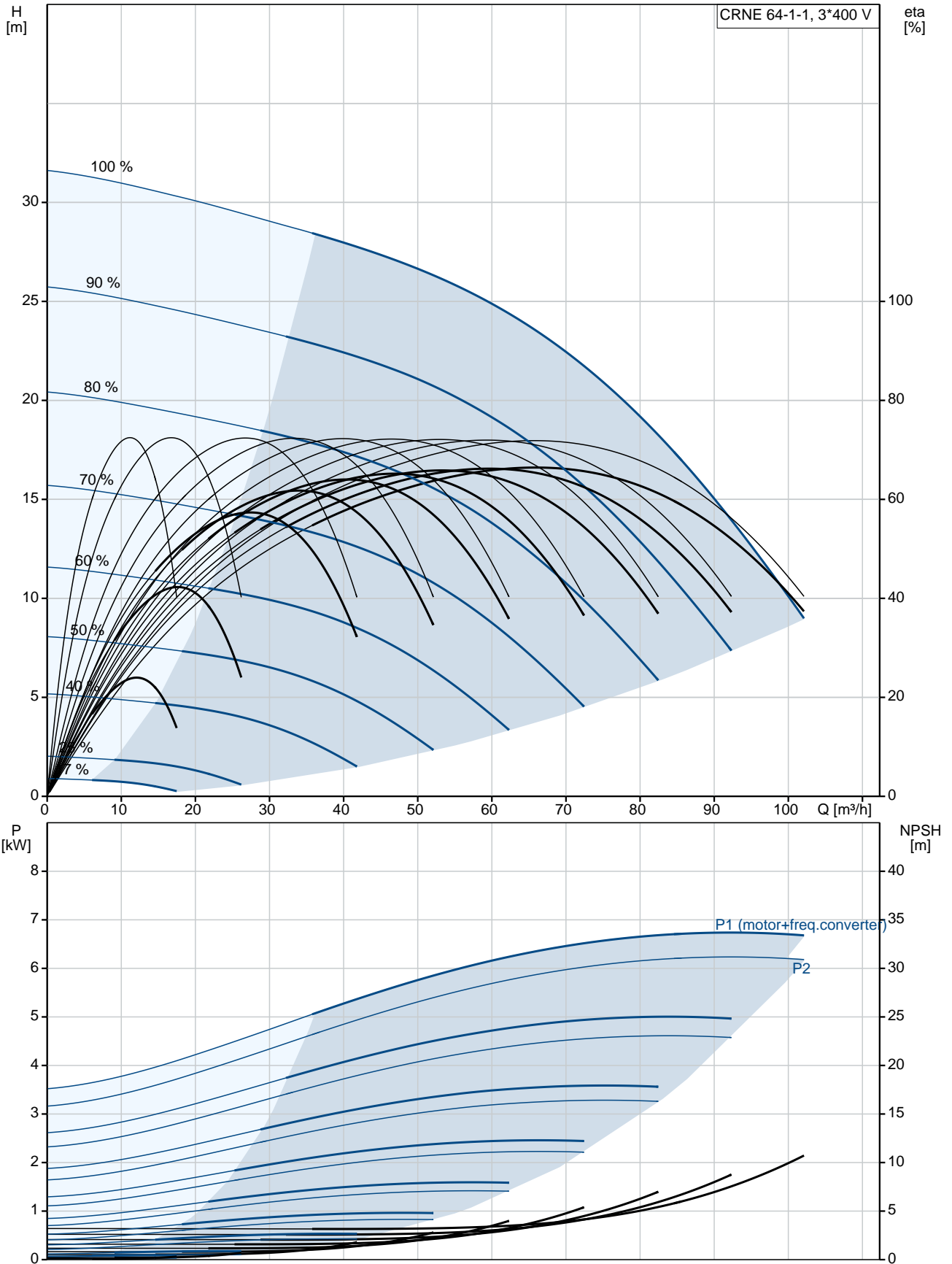

Description	Value
General information:	
Product name:	CRNE 64-1-1 A-F-A-E-HQQE
Product No:	99072078
EAN number:	5712606204045 5712606204045
Price:	6.565,00 GBP
Technical:	
Pump speed on which pump data are based:	3525 rpm
Rated flow:	77 m ³ /h
Rated head:	20.8 m
Head max:	32 m
Stages:	1
Impellers:	1
Number of reduced-diameter impellers:	1
Low NPSH:	No
Pump orientation:	Vertical
Shaft seal arrangement:	Single
Code for shaft seal:	HQQE
Approvals on nameplate:	CE, EAC, ACS
Curve tolerance:	ISO9906:2012 3B
Pump version:	A
Model:	B
Materials:	
Base:	Stainless steel EN 1.4408 AISI 316
Impeller:	Stainless steel EN 1.4401 AISI 316
Material code:	A
Code for rubber:	E
Bearing:	SIC
Support bearing:	Graflon
Installation:	
Maximum ambient temperature:	50 °C
Maximum operating pressure:	16 bar
Max pressure at stated temp:	16 bar / 120 °C 16 bar / -40 °C
Type of connection:	DIN
Size of inlet connection:	DN 100
Size of outlet connection:	DN 100
Pressure rating for pipe connection:	PN 16
Flange size for motor:	FF265
Connect code:	F
Liquid:	
Pumped liquid:	Water
Liquid temperature range:	-40 .. 120 °C
Selected liquid temperature:	20 °C
Density at selected liquid temperature:	998.2 kg/m ³
Electrical data:	
Motor standard:	IEC
Motor type:	132SF
IE Efficiency class:	IE5
Rated power - P2:	7.5 kW
Power (P2) required by pump:	7.5 kW
Mains frequency:	50 Hz
Rated voltage:	3 x 380-500 V

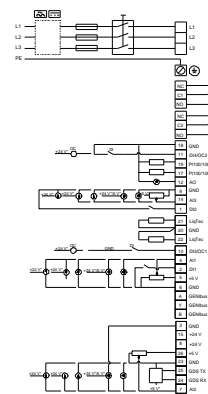
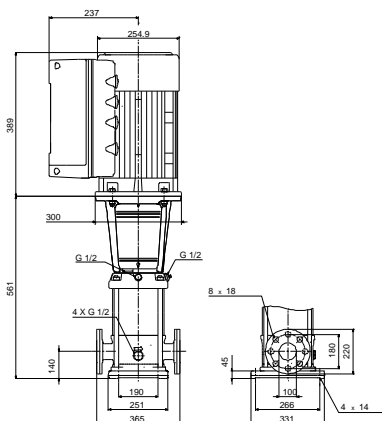
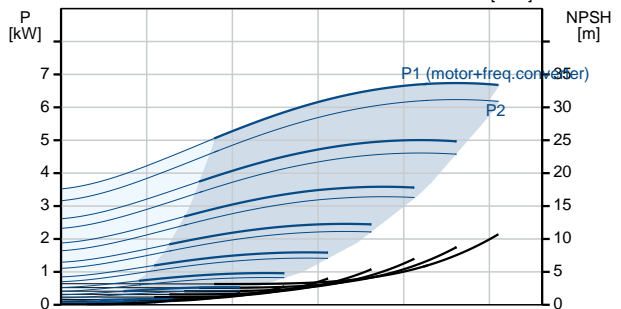
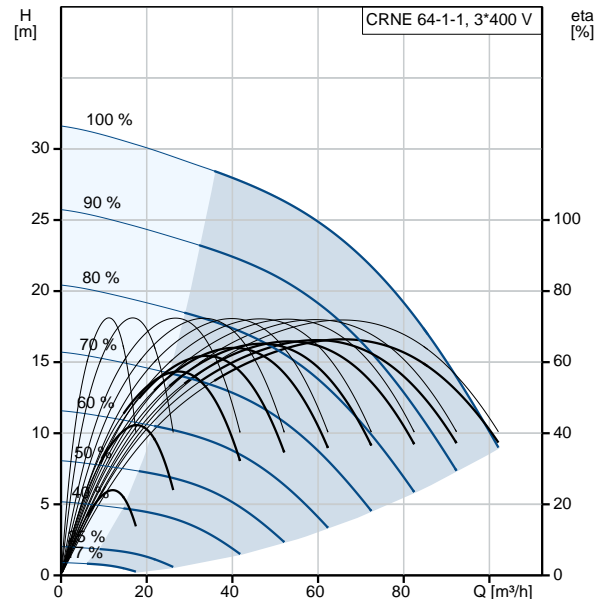



Company name:

Created by:

Phone:

Date:

26/11/2019

Description	Value
Rated current:	14.1-11.2 A
Cos phi - power factor:	0.93-0.89
Rated speed:	360-4000 rpm
Efficiency:	92.5%
Motor efficiency at full load:	92.5 %
Enclosure class (IEC 34-5):	IP55
Insulation class (IEC 85):	F
Motor protec:	YES
Motor No:	98971052
Controls:	
Control panel:	Standard
Function Module:	FM300 - Advanced
Frequency converter:	Built-in
Pressure sensor:	No
Others:	
Minimum efficiency index, MEI :	0.70
Net weight:	107 kg
Gross weight:	140 kg
Shipping volume:	0.495 m ³
Danish VVS No.:	386022061
Country of origin:	GB
Custom tariff no.:	84137075

99072078 CRNE 64-1-1 A-F-A-E-HQQE 50 Hz

