

Qty. Description

1 NB 125-500/526 ASF2ABQQE

Product No.: [98975799](#)

Non-self-priming, single-stage, centrifugal volute pump designed according to ISO 5199 with dimensions and rated performance according to EN 733 (10 bar).

Flanges are PN 16 with dimensions according to EN 1092-2. The pump has an axial suction port, radial discharge port, horizontal shaft and a back pull-out design enabling removal of the motor, motor stool, cover and impeller without disturbing the pump housing or pipework.

The unbalanced rubber bellows seal is according to DIN EN 12756.

The pump is close-coupled to a fan-cooled asynchronous motor.

The back pull-out design means that the pump can be serviced by a single person without disturbing the pump housing or pipes.

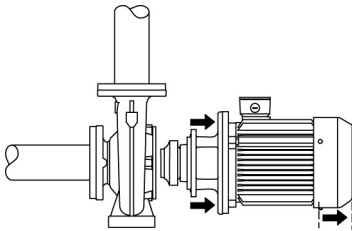

Cast-iron parts have an epoxy-based coating made in a cathodic electro-deposition (CED) process. CED is a high-quality dip-painting process where an electrical field around the products ensures deposition of paint particles as a thin, well-controlled layer on the surface.

Pump

The pump housing has both a priming and a drain hole closed by plugs. The impeller is a closed impeller with double-curved blades with smooth surfaces. The impeller is statically balanced according to ISO 1940-1 class G6.3 and hydraulically balanced to compensate for axial thrust.

Wear rings used in pump housing and for impeller are made of bronze/brass.

Motor stool and pump cover are made of cast iron (EN-GJL-250). Coupling guards are fitted to the motor stool. The pump cover is provided with a manual air vent screw for venting of the pump housing and the shaft seal chamber.

The pump is fitted with an unbalanced rubber bellows seal with torque transmission across the spring and around the bellows. Due to the bellows, the seal does not wear the shaft, and the axial movement is not prevented by deposits on the shaft.

Primary seal:

- Rotating seal ring material: silicon carbide (SiC)
- Stationary seat material: silicon carbide (SiC)

This material pairing is used where higher corrosion resistance is required. The high hardness of this material pairing offers good resistance against abrasive particles.

Secondary seal material: EPDM (ethylene-propylene rubber)

EPDM has excellent resistance to hot water. EPDM is not suitable for mineral oils.

The pump housing has feet.

The pump is to be secured to the foundation with bolts through the pump housing feet and motor feet. The pump is delivered with steel support blocks. The support blocks provide horizontal alignment of the pump and ensure clearance between the motor stool/motor flange and the foundation.

Motor

Qty. Description

The motor is a totally enclosed, fan-cooled motor with principal dimensions to IEC and DIN standards. Electrical tolerances comply with IEC 60034.

The motor efficiency is classified as IE3 in accordance with IEC 60034-30-1.

The motor has thermistors (PTC sensors) in the windings in accordance with DIN 44081/DIN 44082. The protection reacts to both slow- and quick-rising temperatures, e.g. constant overload and stalled conditions.

Thermal switches must be connected to an external control circuit in a way which ensures that the automatic reset cannot cause accidents. The motors must be connected to a motor-protective circuit breaker according to local regulations.

A variable speed drive makes adjustment of pump performance to any duty point possible. If the motor is to be connected to a variable speed drive, the pump must be ordered with an electrically insulated motor bearing.

Further product details
Technical data
Controls:

Frequency converter: NONE

Pressure sensor: N

Liquid:

Pumped liquid: Water

Liquid temperature range: -25 .. 120 °C

Selected liquid temperature: 20 °C

Density: 998.2 kg/m³

Technical:

Pump speed on which pump data are based: 1490 rpm

Rated flow: 325.2 m³/h

Rated head: 88.49 m

Actual impeller diameter: 526 mm

Nominal impeller diameter: 500

Shaft seal arrangement: Single

Code for shaft seal: BQQE

Curve tolerance: ISO9906:2012 3B

Bearing design: Standard

Materials:

Pump housing: Cast iron
EN-GJL-250
ASTM class 35

Wear ring: Brass

Impeller: Cast iron
EN-GJL-200
ASTM class 30

Shaft: Stainless steel
EN 1.4301
AISI 304

Internal pump house coating: CED

Installation:

Maximum ambient temperature: 55 °C

Maximum operating pressure: 16 bar

Pipe connection standard: EN 1092-2

Size of inlet connection: DN 150

Qty.	Description
	<p>Size of outlet connection: DN 125 Pressure rating for connection: PN 16 Bearing lubrication: Grease Pump housing with feet: Yes Support block: Y</p> <p>Electrical data: Motor type: SIEMENS IE Efficiency class: IE3 Rated power - P2: 132 kW Mains frequency: 50 Hz Rated voltage: 3 x 380-420D/660-725Y V Rated current: 240-220/140-128 A Starting current: 730-730 % Cos phi - power factor: 0.9 Rated speed: 1490 rpm Efficiency: IE3 95,6% Motor efficiency at full load: 95.6-95.6 % Motor efficiency at 3/4 load: 95.9-95.9 % Motor efficiency at 1/2 load: 95.9-95.9 % Number of poles: 4 Enclosure class (IEC 34-5): IP55 Insulation class (IEC 85): F Motor No: 83V15446</p> <p>Others: Minimum efficiency index, MEI ≥: 0.50 Net weight: 1520 kg Gross weight: 1610 kg Shipping volume: 1.82 m³ Country of origin: HU Custom tariff no.: 84137051</p>



Company name:

Created by:

Phone:

Date:

12/08/2021

98975799 NB 125-500/526 ASF2ABQQE 50 Hz

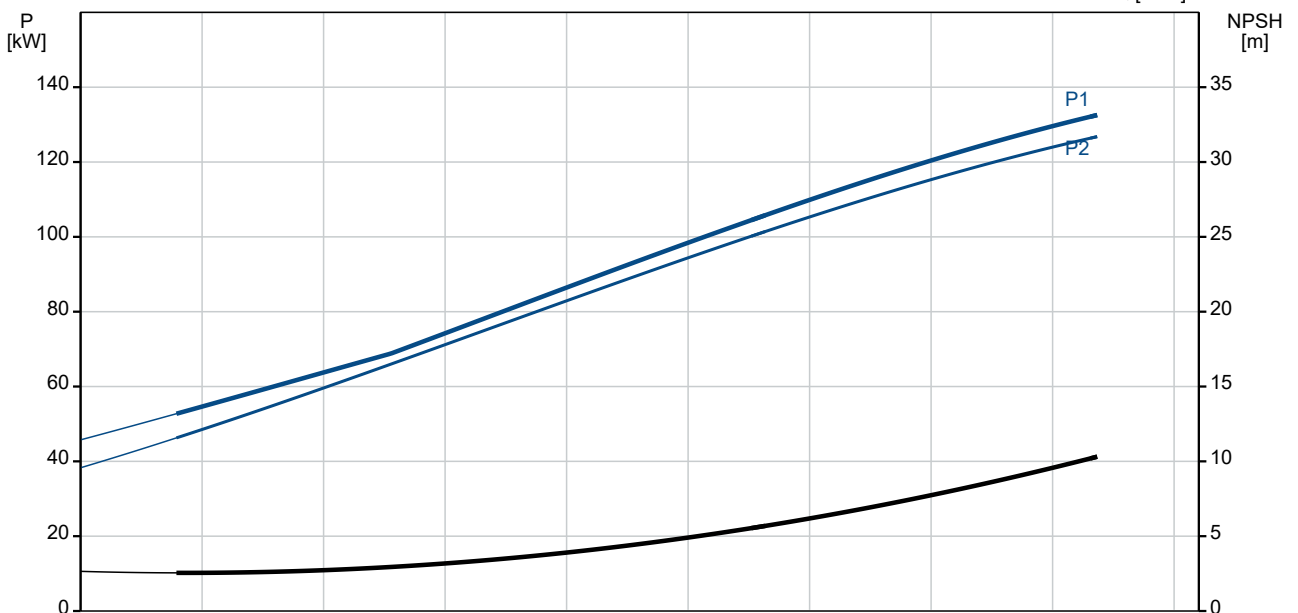
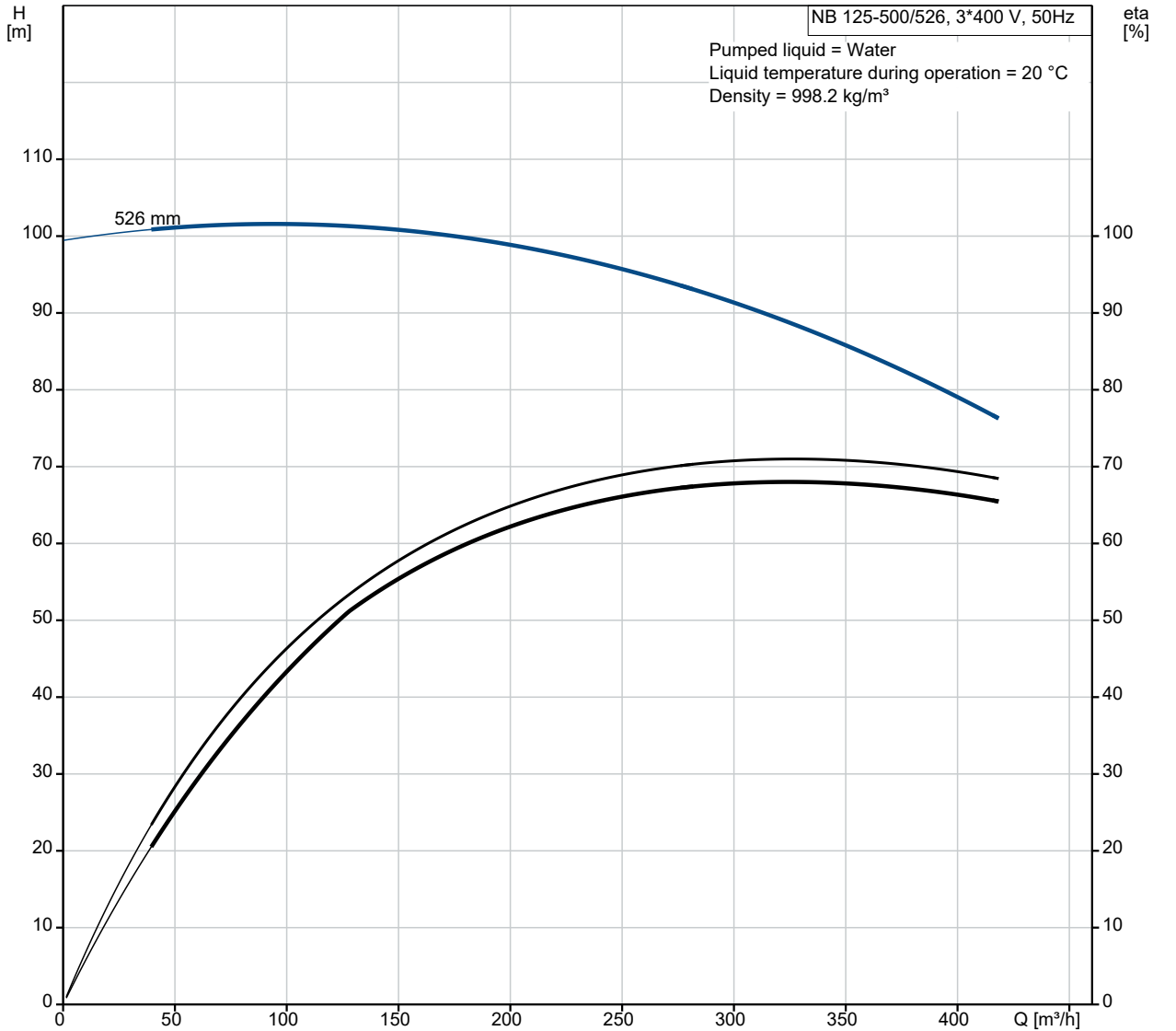

Description	Value
General information:	
Product name:	NB 125-500/526 ASF2ABQQE
Product No:	98975799
EAN number:	5712604549766
Technical:	
Pump speed on which pump data are based:	1490 rpm
Rated flow:	325.2 m ³ /h
Rated head:	88.49 m
Actual impeller diameter:	526 mm
Nominal impeller diameter:	500
Shaft seal arrangement:	Single
Shaft diameter:	60 mm
Code for shaft seal:	BQQE
Curve tolerance:	ISO9906:2012 3B
Pump version:	AS
Bearing design:	Standard
Materials:	
Pump housing:	Cast iron
Pump housing:	EN-GJL-250
Pump housing:	ASTM class 35
Wear ring:	Brass
Impeller:	Cast iron
Impeller:	EN-GJL-200
Impeller:	ASTM class 30
Shaft:	Stainless steel
Shaft:	EN 1.4301
Shaft:	AISI 304
Internal pump house coating:	CED
Material code:	A
Code for rubber:	E
Installation:	
Maximum ambient temperature:	55 °C
Maximum operating pressure:	16 bar
Pipe connection standard:	EN 1092-2
Size of inlet connection:	DN 150
Size of outlet connection:	DN 125
Pressure rating for connection:	PN 16
Bearing lubrication:	Grease
Pump housing with feet:	Yes
Support block:	Y
Connect code:	F2
Liquid:	
Pumped liquid:	Water
Liquid temperature range:	-25 .. 120 °C
Selected liquid temperature:	20 °C
Density:	998.2 kg/m ³
Electrical data:	
Motor type:	SIEMENS
IE Efficiency class:	IE3
Rated power - P2:	132 kW
Mains frequency:	50 Hz
Rated voltage:	3 x 380-420D/660-725Y V
Rated current:	240-220/140-128 A
Starting current:	730-730 %
Cos phi - power factor:	0.9
Rated speed:	1490 rpm

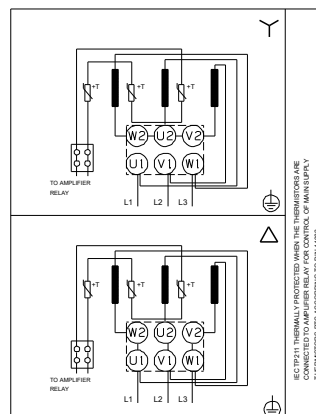
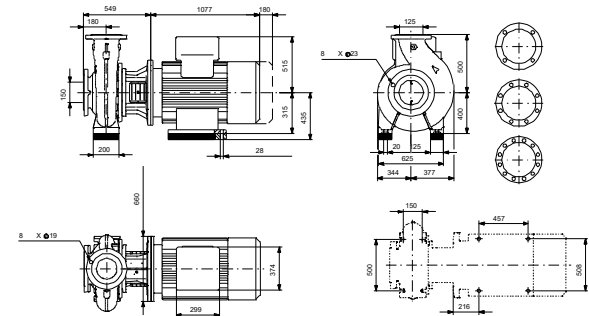
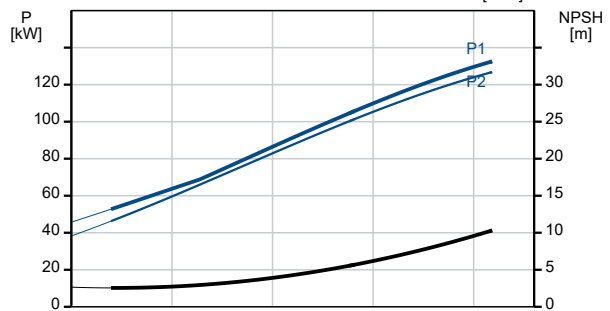
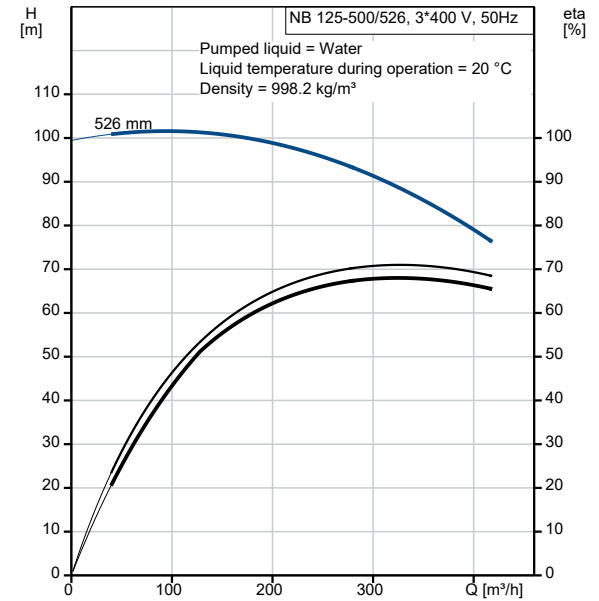



Company name:

Created by:

Phone:

Date:

12/08/2021

Description	Value
Efficiency:	IE3 95,6%
Motor efficiency at full load:	95.6-95.6 %
Motor efficiency at 3/4 load:	95.9-95.9 %
Motor efficiency at 1/2 load:	95.9-95.9 %
Number of poles:	4
Enclosure class (IEC 34-5):	IP55
Insulation class (IEC 85):	F
Motor protec:	PTC
Motor No:	83V15446
Mount. design. acc. IEC 34-7:	IM B35
Controls:	
Frequency converter:	NONE
Pressure sensor:	N
Others:	
Minimum efficiency index, MEI ≥:	0.50
Net weight:	1520 kg
Gross weight:	1610 kg
Shipping volume:	1.82 m ³
Country of origin:	HU
Custom tariff no.:	84137051

98975799 NB 125-500/526 ASF2ABQQE 50 Hz

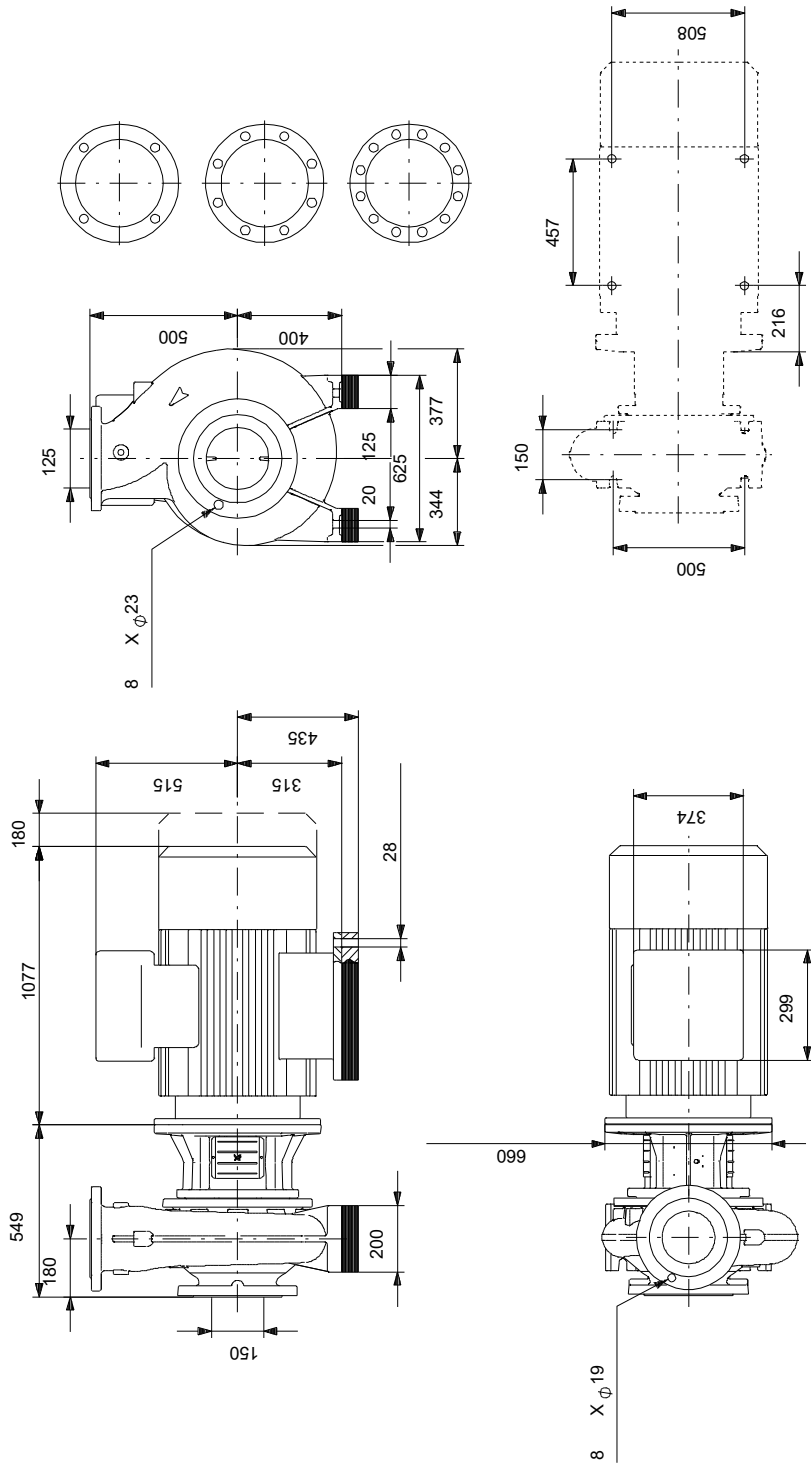

Note! All units are in [mm] unless others are stated.
Disclaimer: This simplified dimensional drawing does not show all details.

98975799 NB 125-500/526 ASF2ABQQE 50 Hz



IEC TP211 THERMALLY PROTECTED WHEN THE THERMISTORS ARE
CONNECTED TO AMPLIFIER RELAY FOR CONTROL OF MAIN SUPPLY
THERMISTORS PTC ACCORDING TO DIN 44082

Note! All units are in [mm] unless others are stated.