

Qty.	Description
------	-------------

1	SP 14-11
---	----------



Note! Product picture may differ from actual product

Product No.: [98699356](#)

Submersible borehole pump, suitable for pumping clean water. Can be installed vertically or horizontally. All steel components are made in stainless steel, EN 1.4301 (AISI 304), that ensures high corrosive resistance. This pump carries drinking water approval.

The pump is fitted with a 3 kW MS4000 motor with sand shield, mechanical shaft seal, water-lubricated journal bearings and a volume compensating diaphragm. The motor is a canned type submersible motor offering good mechanical stability and high efficiency. Suitable for temperatures up to 40 °C.

The motor is not fitted with a temperature sensor. If temperature monitoring is desired, a Pt1000 sensor can be fitted.

The motor is for direct-on-line starting (DOL).

### Further product details

The pump is suitable for applications similar to the following:

- raw-water supply
- irrigation
- groundwater lowering
- pressure boosting
- fountain applications.

The Grundfos SP pump is renowned for its high efficiency and already complies with the requirements of the Minimum Efficiency Index, and therefore Grundfos is amongst the best in class within submersible pumps.



### Pump

All pump surfaces that are in contact with pumped liquids are made in stainless steel which makes them corrosion- and wear-resistant. The corrosion diagram below shows the capabilities of the pump and motor in relation to the temperature in Celsius (y-axis) and the concentration of chloride in ppm (x-axis).



The elastomer parts in the pump offer good wear resistance and long service intervals. The bearings are made of LSR (Liquid Silicone Rubber), sealing rings are made of TPU (Thermoplastic Poly-Urethane) and the non-return valve is made of NBR (Nitrile-Butadiene Rubber). The special elastomer material of the bearings offers increased resistance to sand and other abrasive particles (from 50 to 150 mg/l).

In case the pump is used for pumping water with high content of hydrocarbons or solvents, Grundfos offers FKM rubber parts (Fluorocarbon) which are oil and temperature-resistant up to 90 °C.

The pump is built with octagonal bearings with sand flush channels that minimise wear. As wear of the pump is inevitable, the pump design allows for easy replacement of all internal wear parts (bearings, impeller, wear rings and seal rings) to maintain high performance and a long lifetime.

The suction interconnector is fitted with a strainer to prevent large particles from entering the pump. The suction interconnector is designed to comply with NEMA standards for motor mounting/dimensions.

## Motor

The stator is hermetically encapsulated in stainless steel and the windings are embedded in polymer compound. This results in high mechanical stability, optimum cooling and reduces the risk of short circuits in the windings.

The shaft seal is a tungsten carbide/ceramic replaceable mechanical shaft seal. The material combination provides optimum sealing, resistance and long life. Together with the shaft seal housing, the sand shield forms a labyrinth seal, which during normal operating conditions prevents penetration of sand particles into the shaft seal.

The motor can be fitted with a Pt100 or Pt1000 sensor that together with a control unit ensures that the maximum operating temperature conditions are not exceeded.

### Liquid:

Pumped liquid:	Water
Maximum liquid temperature:	40 °C
Max liquid t at 0.15 m/sec:	40 °C
Selected liquid temperature:	20 °C
Density:	998.2 kg/m <sup>3</sup>

### Technical:

Pump speed on which pump data are based:	2900 rpm
Rated flow:	14 m <sup>3</sup> /h
Rated head:	47.3 m
Shaft seal for motor:	HM/CER
Approvals on nameplate:	CE,EAC
Curve tolerance:	ISO9906:2012 3B
Motor version:	T40

### Materials:

Pump:	Stainless steel EN 1.4301 AISI AISI 304
Impeller:	Stainless steel EN 1.4301 AISI AISI 304
Motor:	Stainless steel DIN W.-Nr. 1.4301

Qty.	Description
	<p data-bbox="566 340 662 369">AISI 304</p> <p data-bbox="199 403 327 432">Installation:</p> <p data-bbox="199 432 343 461">Pump outlet: Rp2</p> <p data-bbox="199 461 375 490">Motor diameter: 4 inch</p> <p data-bbox="199 521 367 551">Electrical data:</p> <p data-bbox="199 551 327 580">Motor type: MS4000</p> <p data-bbox="199 580 406 609">Rated power - P2: 3 kW</p> <p data-bbox="199 609 534 638">Power (P2) required by pump: 3 kW</p> <p data-bbox="199 638 391 667">Mains frequency: 50 Hz</p> <p data-bbox="199 667 359 696">Rated voltage: 3 x 380-400-415 V</p> <p data-bbox="199 696 359 725">Rated current: 7.70-7.85-8.10 A</p> <p data-bbox="199 725 375 754">Starting current: 460-490-500 %</p> <p data-bbox="199 754 454 784">Cos phi - power factor: 0.82-0.77-0.73</p> <p data-bbox="199 784 351 813">Rated speed: 2850-2865-2875 rpm</p> <p data-bbox="199 813 359 842">Start. method: direct-on-line</p> <p data-bbox="199 842 502 871">Enclosure class (IEC 34-5): IP68</p> <p data-bbox="199 871 478 900">Insulation class (IEC 85): F</p> <p data-bbox="199 900 478 929">Built-in temp. transmitter: no</p> <p data-bbox="199 929 319 958">Motor No: 79194508</p> <p data-bbox="199 990 279 1019">Others:</p> <p data-bbox="199 1019 678 1048">Minimum efficiency index, MEI <math>\eta_{\%}</math>: 0.50</p> <p data-bbox="199 1048 805 1077">ErP status: EuP Standalone/Prod.</p> <p data-bbox="199 1077 646 1106">Net weight: 30.7 kg</p> <p data-bbox="199 1106 646 1135">Gross weight: 55.9 kg</p> <p data-bbox="199 1135 638 1164">Shipping volume: 0.2 m<sup>3</sup></p> <p data-bbox="199 1164 686 1193">Danish VVS No.: 388482011</p> <p data-bbox="199 1193 662 1223">Finnish LVI No.: 4762708</p> <p data-bbox="199 1223 598 1252">Country of origin: DK</p> <p data-bbox="199 1252 678 1281">Custom tariff no.: 84137029</p>

## 98699356 SP 14-11 50 Hz

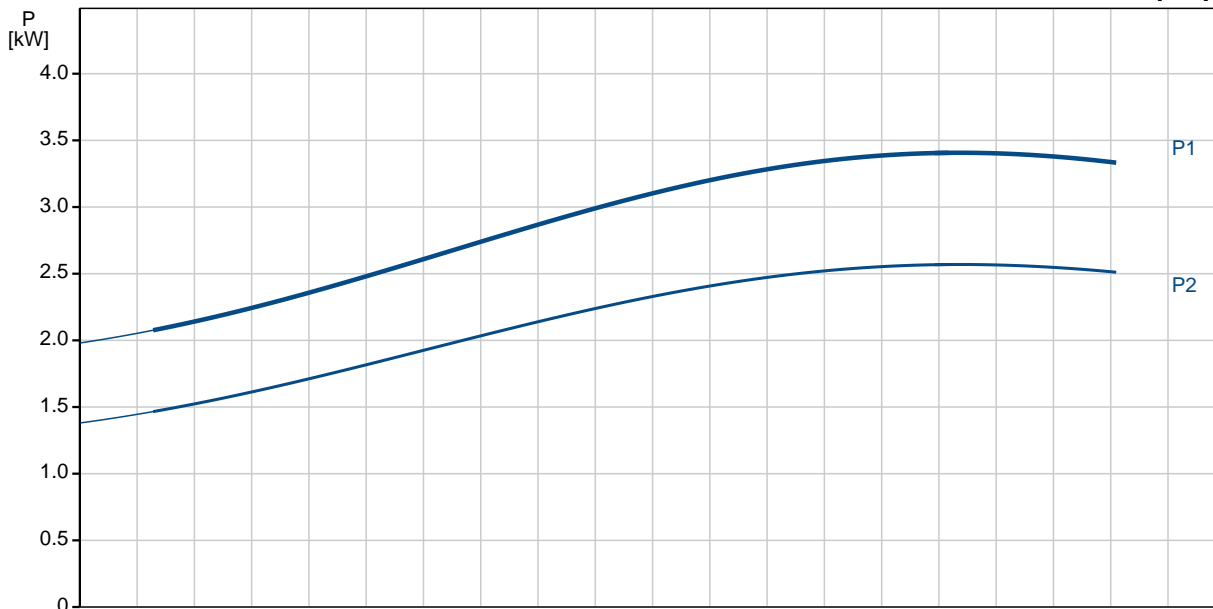
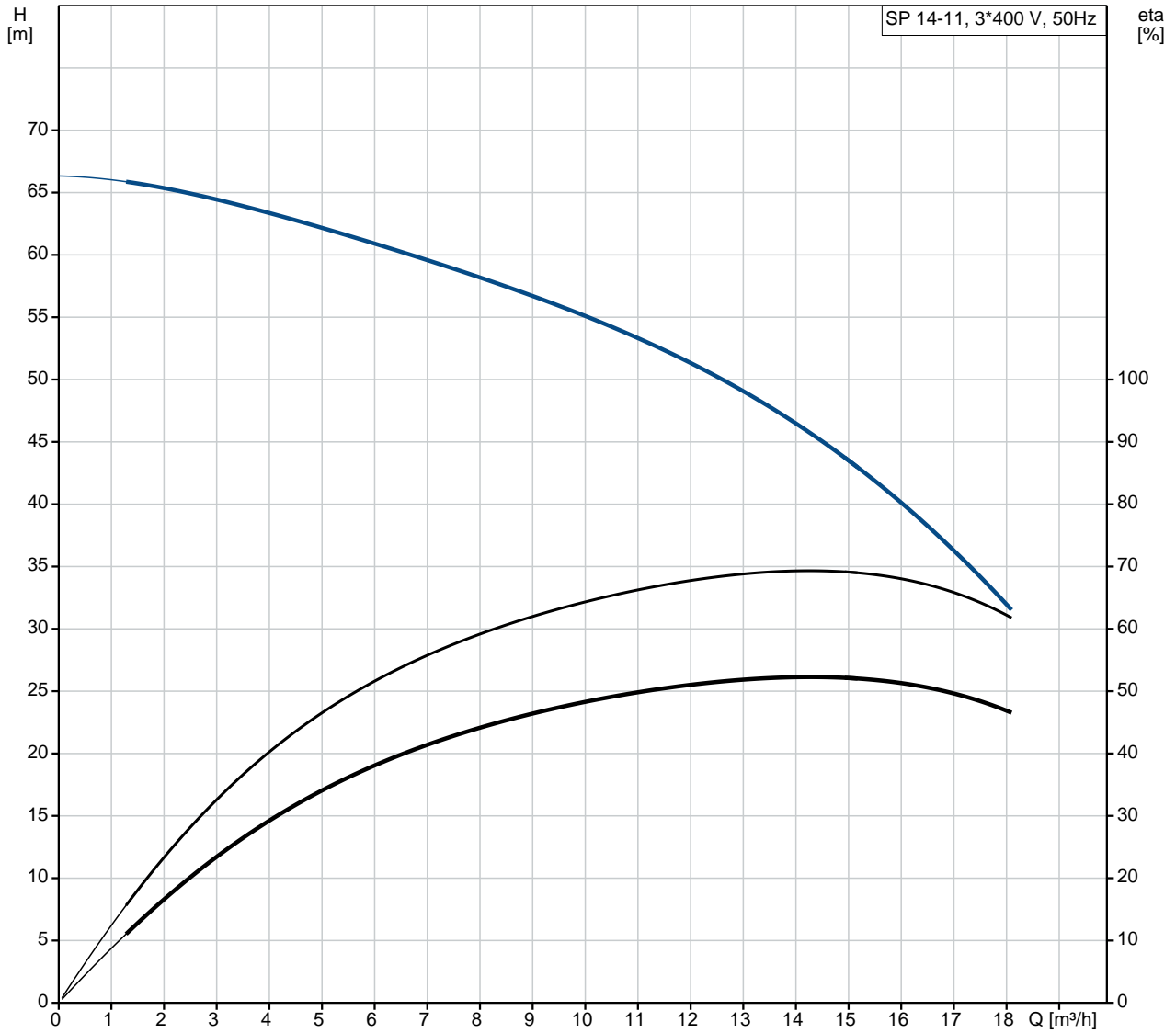

Description	Value
<b>General information:</b>	
Product name:	SP 14-11
Product No:	98699356
EAN number:	5712600111950
Price:	GBP 2123
<b>Technical:</b>	
Pump speed on which pump data are based:	2900 rpm
Rated flow:	14 m <sup>3</sup> /h
Rated head:	47.3 m
Stages:	11
Impeller reduc.:	NONE
Shaft seal for motor:	HM/CER
Approvals on nameplate:	CE,EAC
Curve tolerance:	ISO9906:2012 3B
Model:	A
Valve:	YES
Motor version:	T40
<b>Materials:</b>	
Pump:	Stainless steel
Pump:	EN 1.4301
Pump:	AISI AISI 304
Impeller:	Stainless steel
Impeller:	EN 1.4301
Impeller:	AISI AISI 304
Motor:	Stainless steel
Motor:	DIN W.-Nr. 1.4301
Motor:	AISI 304
<b>Installation:</b>	
Pump outlet:	Rp2
Motor diameter:	4 inch
<b>Liquid:</b>	
Pumped liquid:	Water
Maximum liquid temperature:	40 °C
Max liquid t at 0.15 m/sec:	40 °C
Selected liquid temperature:	20 °C
Density:	998.2 kg/m <sup>3</sup>
<b>Electrical data:</b>	
Motor type:	MS4000
Applic. motor:	NEMA
Rated power - P2:	3 kW
Power (P2) required by pump:	3 kW
Mains frequency:	50 Hz
Rated voltage:	3 x 380-400-415 V
Rated current:	7.70-7.85-8.10 A
Starting current:	460-490-500 %
Cos phi - power factor:	0.82-0.77-0.73
Rated speed:	2850-2865-2875 rpm
Start. method:	direct-on-line
Enclosure class (IEC 34-5):	IP68
Insulation class (IEC 85):	F
Motor protec:	NONE
Thermal protec:	external
Built-in temp. transmitter:	no
Motor No:	79194508
<b>Others:</b>	
Minimum efficiency index, MEI %:	0.50
ErP status:	EuP Standalone/Prod.

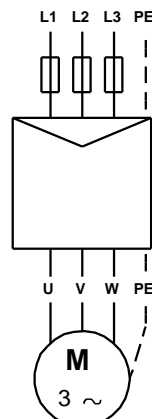
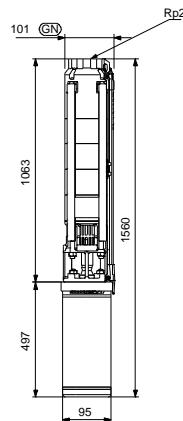
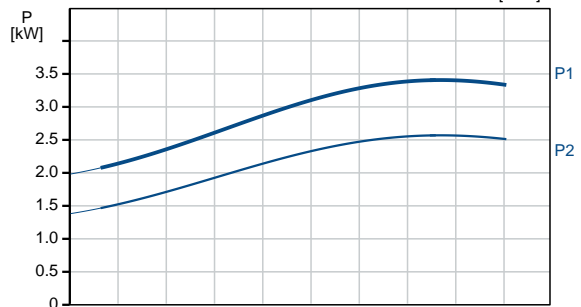
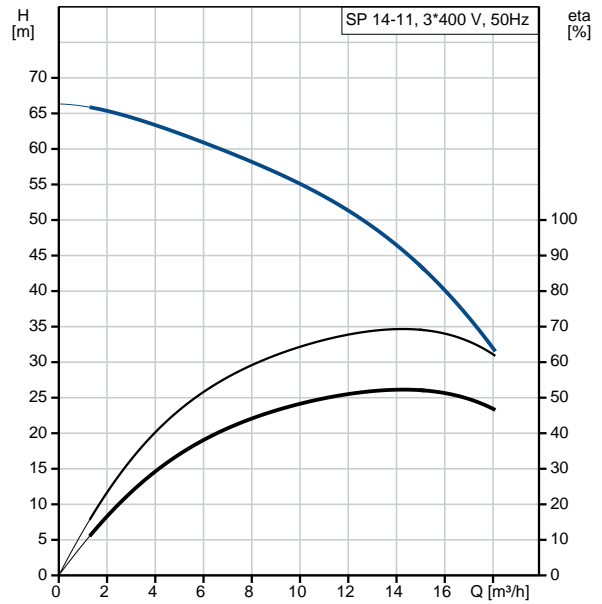



Company name:

Created by:

Phone:

Date:

05/11/2020

Description	Value
Net weight:	30.7 kg
Gross weight:	55.9 kg
Shipping volume:	0.2 m <sup>3</sup>
Danish VVS No.:	388482011
Finnish LVI No.:	4762708
Country of origin:	DK
Custom tariff no.:	84137029

## 98699356 SP 14-11 50 Hz

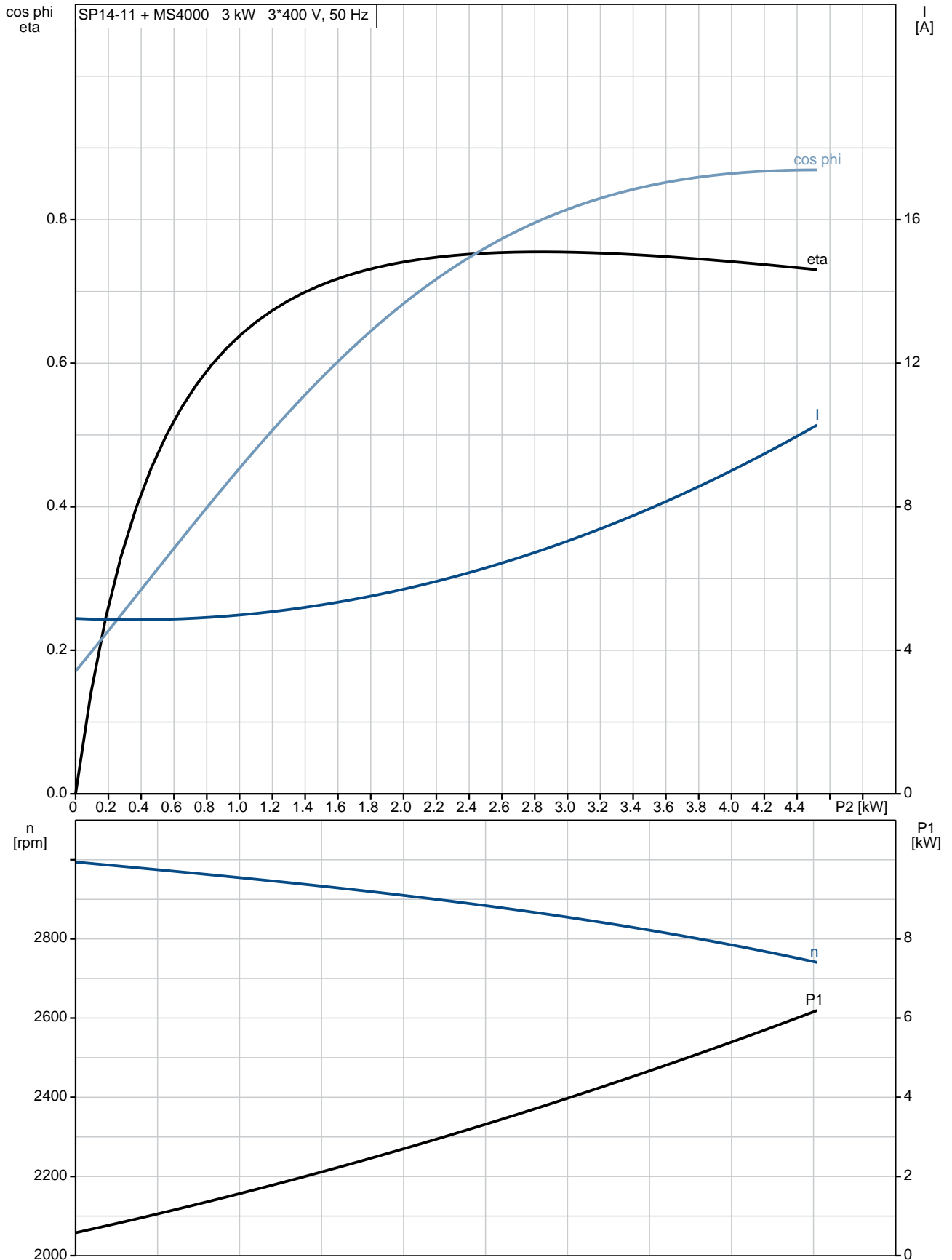

## 98699356 SP 14-11 50 Hz

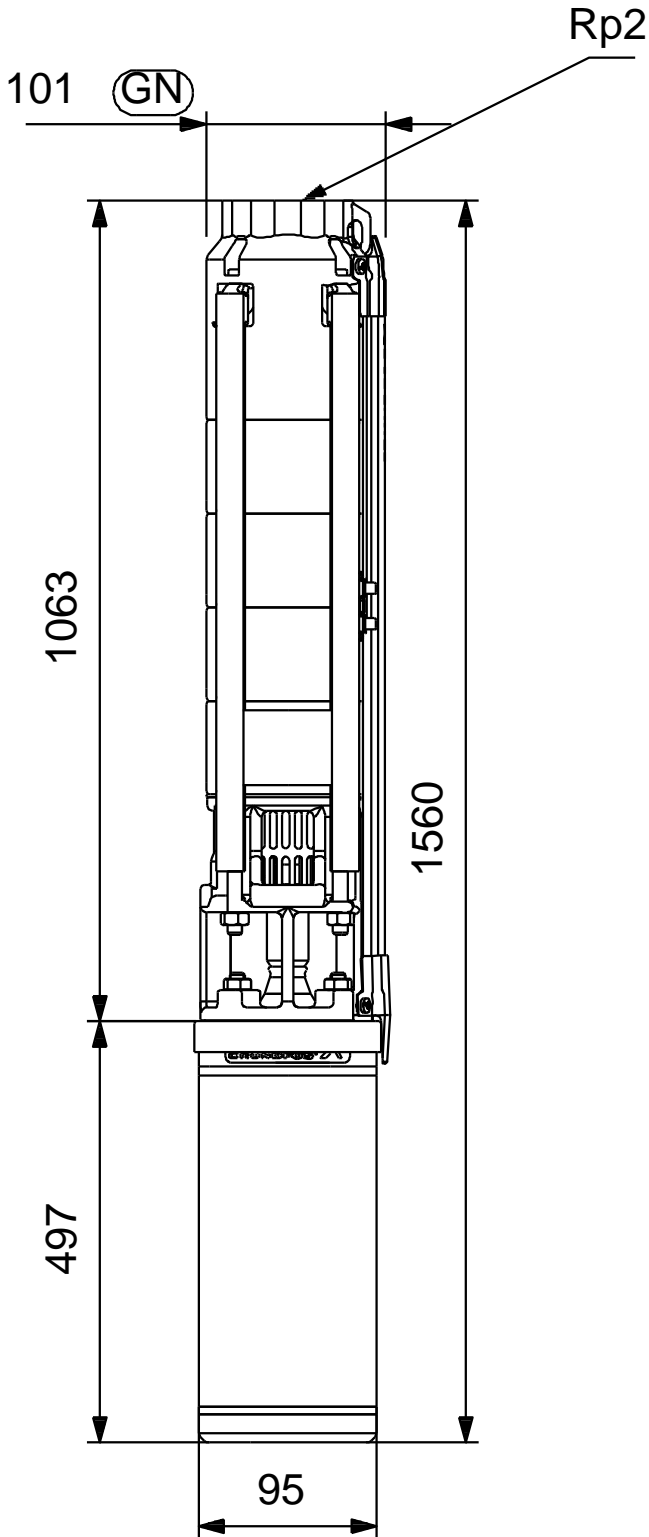

Note! All units are in [mm] unless others are stated.  
Disclaimer: This simplified dimensional drawing does not show all details.



98699356 SP 14-11 50 Hz



Note! All units are in [mm] unless others are stated.