

Position	Count	Description																																										
	1	<p><b>SLV.65.65.22.A.2.50D.C</b></p>  <p style="text-align: center;">Product photo could vary from the actual product</p> <p>Product No.: <a href="#">98626169</a></p> <p>Non-self-priming, single-stage, centrifugal pump designed for handling wastewater, process water and unscreened raw sewage.</p> <p>The pump is designed for intermittent and continuous operations in submerged installation. The efficient SuperVortex impeller provides passage of long fibres and solids up to 2 9/16 in and is suitable for wastewater with a dry matter content of up to 5 %.</p> <p>A unique stainless-steel clamp assembling system enables quick and easy disassembly of the pump from the motor unit for service and inspection. No special tools are required. Pipework connection is via a DIN flange.</p> <p><b>Controls:</b></p> <table> <tr> <td>Moisture sensor:</td> <td>with moisture sensors</td> </tr> <tr> <td>Water-in-oil sensor:</td> <td>with water-in-oil sensor</td> </tr> </table> <p><b>Liquid:</b></p> <table> <tr> <td>Pumped liquid:</td> <td>any viscous fluid</td> </tr> <tr> <td>Maximum liquid temperature:</td> <td>104 °F</td> </tr> <tr> <td>Density:</td> <td>62.29 lb/ft<sup>3</sup></td> </tr> </table> <p><b>Technical:</b></p> <table> <tr> <td>Type of impeller:</td> <td>Super Vortex</td> </tr> <tr> <td>Maximum particle size:</td> <td>2 9/16 in</td> </tr> <tr> <td>Primary shaft seal:</td> <td>SIC/SIC</td> </tr> <tr> <td>Secondary shaft seal:</td> <td>CARBON/CERAMICS</td> </tr> <tr> <td>Approvals on nameplate:</td> <td>CE, EN12050-1</td> </tr> <tr> <td>Curve tolerance:</td> <td>ISO9906:2012 3B2</td> </tr> </table> <p><b>Materials:</b></p> <table> <tr> <td>Pump housing:</td> <td>Cast iron (EN-GJL-250) EN-GJL-250</td> </tr> <tr> <td>Impeller:</td> <td>Cast iron (EN-GJL-250) EN-GJL-250</td> </tr> <tr> <td>Motor:</td> <td>EN-GJL-250</td> </tr> </table> <p><b>Installation:</b></p> <table> <tr> <td>Maximum ambient temperature:</td> <td>104 °F</td> </tr> <tr> <td>Flange standard:</td> <td>DIN</td> </tr> <tr> <td>Pump inlet:</td> <td>80</td> </tr> <tr> <td>Pump outlet:</td> <td>65</td> </tr> <tr> <td>Pressure stage:</td> <td>PN 10</td> </tr> <tr> <td>Maximum installation depth:</td> <td>65.62 ft</td> </tr> <tr> <td>Frame range:</td> <td>B</td> </tr> </table>	Moisture sensor:	with moisture sensors	Water-in-oil sensor:	with water-in-oil sensor	Pumped liquid:	any viscous fluid	Maximum liquid temperature:	104 °F	Density:	62.29 lb/ft <sup>3</sup>	Type of impeller:	Super Vortex	Maximum particle size:	2 9/16 in	Primary shaft seal:	SIC/SIC	Secondary shaft seal:	CARBON/CERAMICS	Approvals on nameplate:	CE, EN12050-1	Curve tolerance:	ISO9906:2012 3B2	Pump housing:	Cast iron (EN-GJL-250) EN-GJL-250	Impeller:	Cast iron (EN-GJL-250) EN-GJL-250	Motor:	EN-GJL-250	Maximum ambient temperature:	104 °F	Flange standard:	DIN	Pump inlet:	80	Pump outlet:	65	Pressure stage:	PN 10	Maximum installation depth:	65.62 ft	Frame range:	B
Moisture sensor:	with moisture sensors																																											
Water-in-oil sensor:	with water-in-oil sensor																																											
Pumped liquid:	any viscous fluid																																											
Maximum liquid temperature:	104 °F																																											
Density:	62.29 lb/ft <sup>3</sup>																																											
Type of impeller:	Super Vortex																																											
Maximum particle size:	2 9/16 in																																											
Primary shaft seal:	SIC/SIC																																											
Secondary shaft seal:	CARBON/CERAMICS																																											
Approvals on nameplate:	CE, EN12050-1																																											
Curve tolerance:	ISO9906:2012 3B2																																											
Pump housing:	Cast iron (EN-GJL-250) EN-GJL-250																																											
Impeller:	Cast iron (EN-GJL-250) EN-GJL-250																																											
Motor:	EN-GJL-250																																											
Maximum ambient temperature:	104 °F																																											
Flange standard:	DIN																																											
Pump inlet:	80																																											
Pump outlet:	65																																											
Pressure stage:	PN 10																																											
Maximum installation depth:	65.62 ft																																											
Frame range:	B																																											



Company name:

Created by:

Phone:

Date:

12/3/2018

Position	Count	Description
		<b>Electrical data:</b> Power input - P1: 2.9 kW Rated power - P2: 3 HP Main frequency: 50 Hz Rated voltage: 3 x 380-415 V Voltage tolerance: +10/-10 % Max starts per. hour: 20 Rated current: 5.1-4.8 A Cos phi - power factor: 0.88 Cos phi - p.f. at 3/4 load: 0.83 Cos phi - p.f. at 1/2 load: 0.74 Rated speed: 2900 rpm Motor efficiency at full load: 85.1 % Motor efficiency at 3/4 load: 85.6 % Motor efficiency at 1/2 load: 83.9 % Number of poles: 2 Start. method: direct-on-line Enclosure class (IEC 34-5): IP68 Insulation class (IEC 85): H Explosion proof: no Length of cable: 33 ft Cable type: LYNIFLEX  <b>Others:</b> Net weight: 143 lb Country of origin: HU Custom tariff no.: 84137021



Company name:  
Created by:  
Phone:

Date: 12/3/2018

### 98626169 SLV.65.65.22.A.2.50D.C 50 Hz

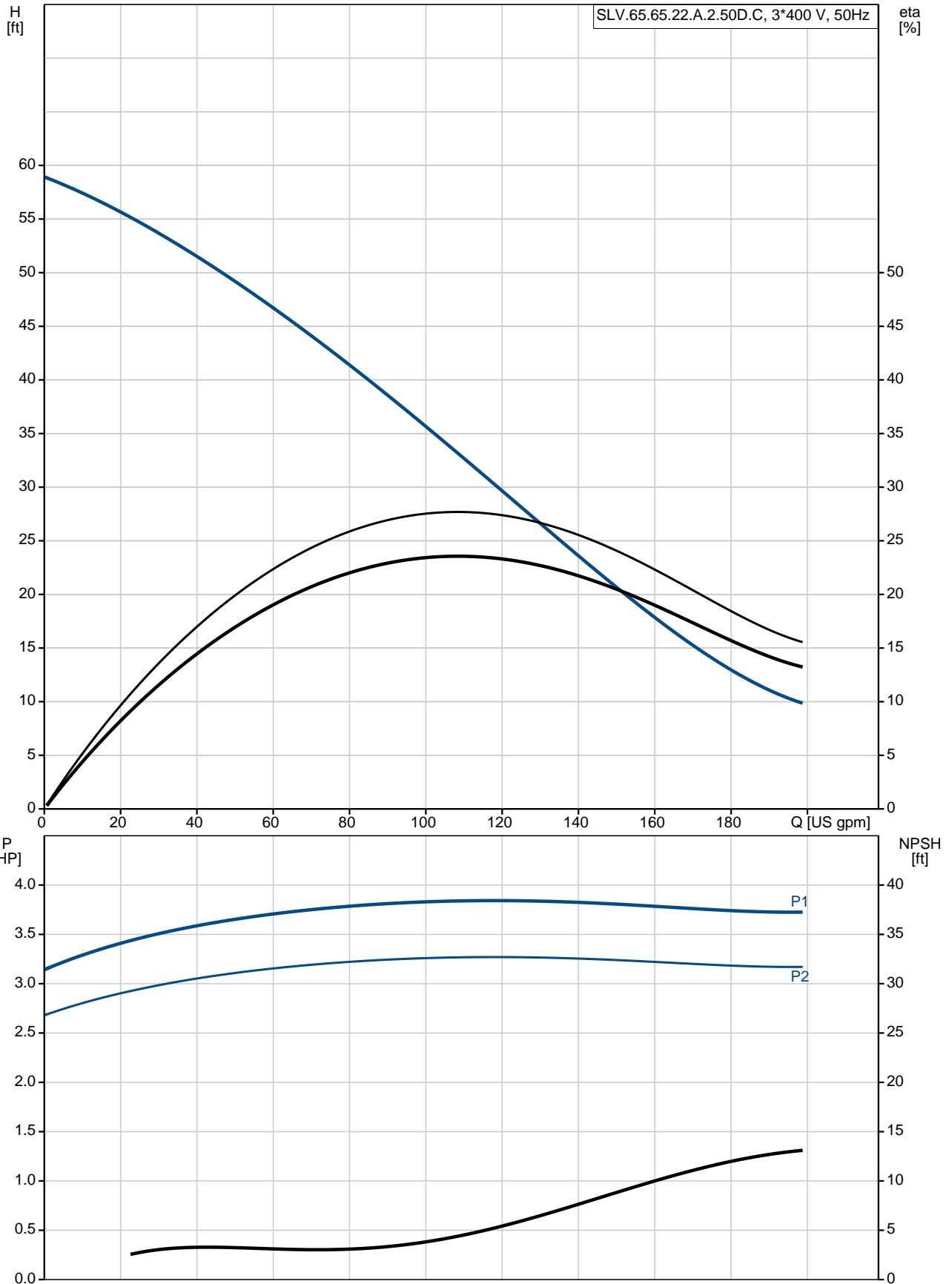

Description	Value
<b>General information:</b>	
Product name:	SLV.65.65.22.A.2.50D.C
Product No.:	98626169
EAN:	5711498467347
<b>Technical:</b>	
Max flow:	198 US gpm
Head max:	59.06 ft
Type of impeller:	Super Vortex
Maximum particle size:	2 9/16 in
Primary shaft seal:	SIC/SIC
Secondary shaft seal:	CARBON/CERAMICS
Approvals on nameplate:	CE, EN12050-1
Curve tolerance:	ISO9906:2012 3B2
Cooling jacket:	without cooling jacket
<b>Materials:</b>	
Pump housing:	Cast iron (EN-GJL-250) EN-GJL-250
Impeller:	Cast iron (EN-GJL-250) EN-GJL-250
Motor:	EN-GJL-250
<b>Installation:</b>	
Maximum ambient temperature:	104 °F
Flange standard:	DIN
Pump inlet:	80
Pump outlet:	65
Pressure stage:	PN 10
Maximum installation depth:	65.62 ft
Inst dry/wet:	SUBMERGED
Installation:	Vertical
Frame range:	B
<b>Liquid:</b>	
Pumped liquid:	any viscous fluid
Maximum liquid temperature:	104 °F
Density:	62.29 lb/ft³
<b>Electrical data:</b>	
Power input - P1:	2.9 kW
Rated power - P2:	3 HP
Main frequency:	50 Hz
Rated voltage:	3 x 380-415 V
Voltage tolerance:	+10/-10 %
Max starts per. hour:	20
Rated current:	5.1-4.8 A
Cos phi - power factor:	0.88
Cos phi - p.f. at 3/4 load:	0.83
Cos phi - p.f. at 1/2 load:	0.74
Rated speed:	2900 rpm
Motor efficiency at full load:	85.1 %
Motor efficiency at 3/4 load:	85.6 %
Motor efficiency at 1/2 load:	83.9 %
Number of poles:	2
Start. method:	direct-on-line
Enclosure class (IEC 34-5):	IP68
Insulation class (IEC 85):	H
Explosion proof:	no
Motor protection:	Pt1000
Length of cable:	33 ft
Cable type:	LYNIFLEX
<b>Controls:</b>	

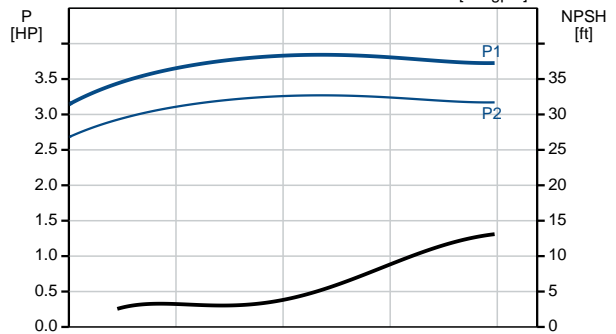
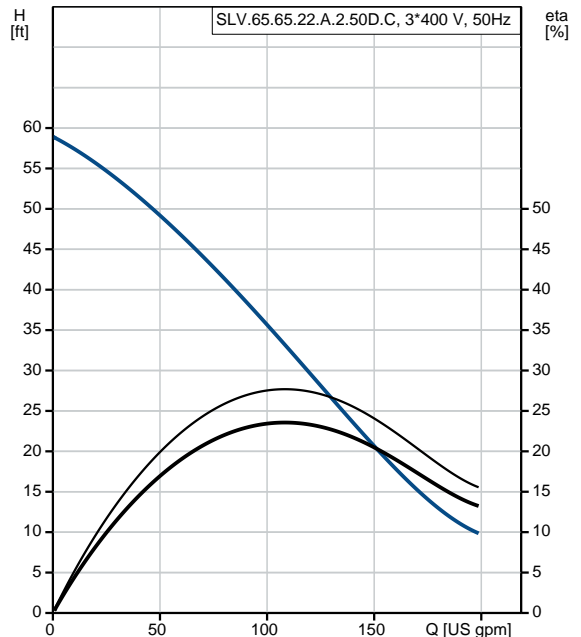



Company name:

Created by:

Phone:

Date:

12/3/2018

Description	Value
Control box:	not included
Moisture sensor:	with moisture sensors
Water-in-oil sensor:	with water-in-oil sensor
<b>Others:</b>	
Net weight:	143 lb
Country of origin:	HU
Custom tariff no.:	84137021

## 98626169 SLV.65.65.22.A.2.50D.C 50 Hz

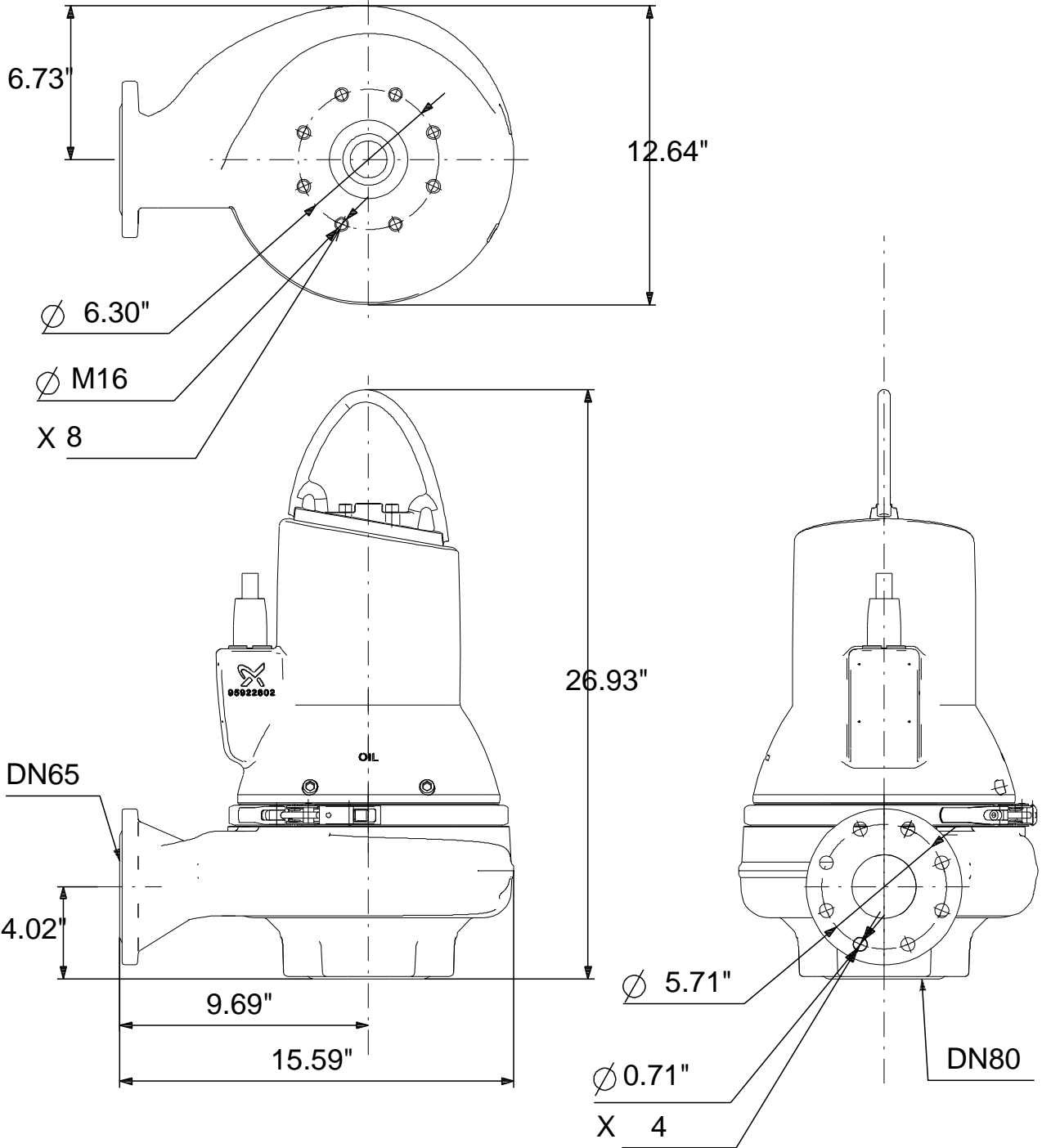

160x160

Note! All units are in [mm] unless otherwise stated.  
Disclaimer: This simplified dimensional drawing does not show all details.

## 98626169 SLV.65.65.22.A.2.50D.C 50 Hz

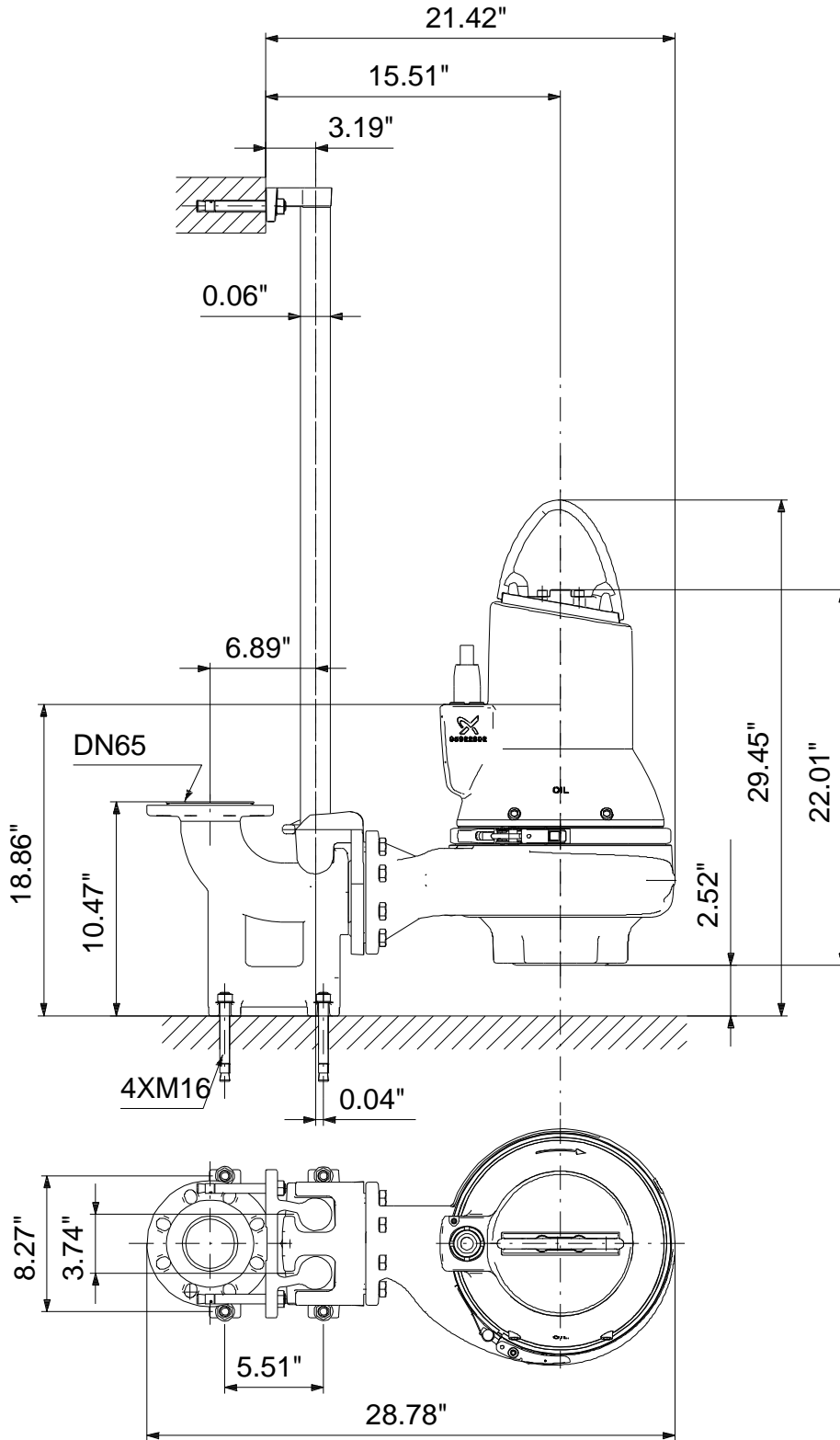

Note! All units are in [mm] unless otherwise stated.  
Disclaimer: This simplified dimensional drawing does not show all details.

**98626169 SLV.65.65.22.A.2.50D.C 50 Hz**

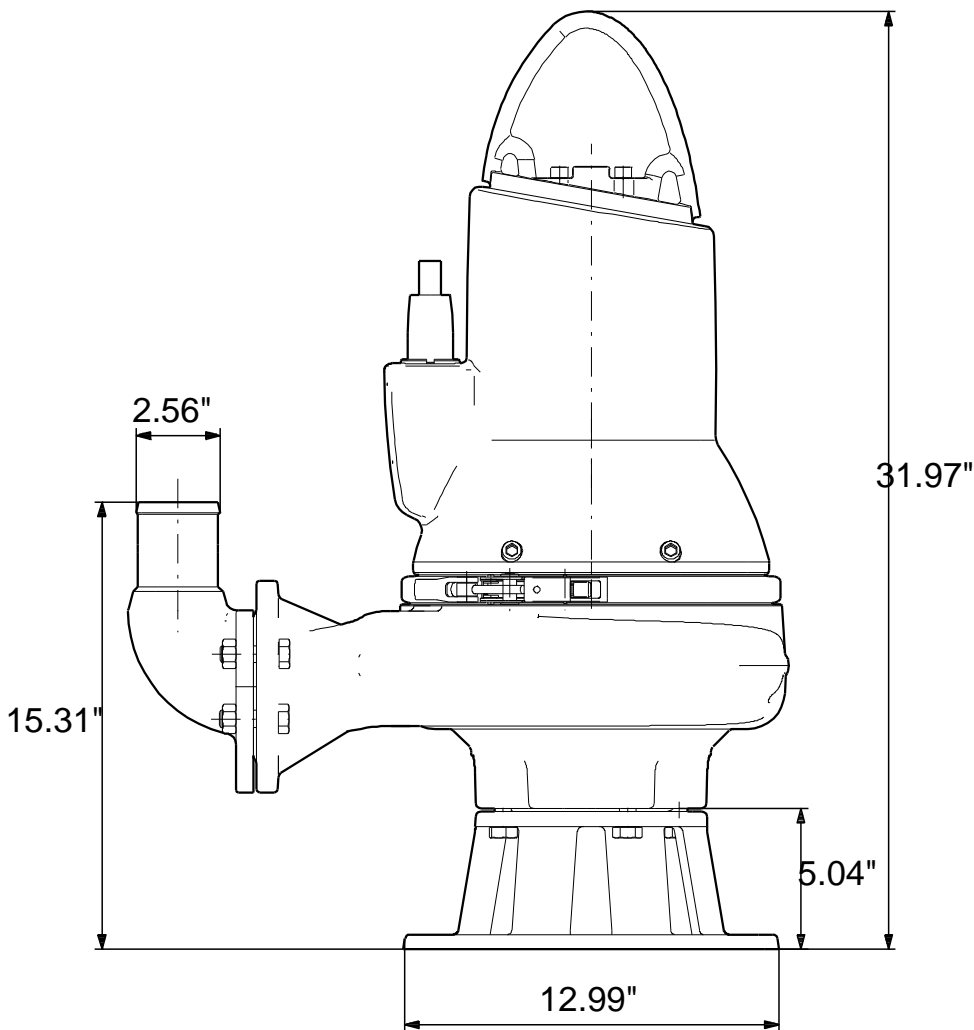
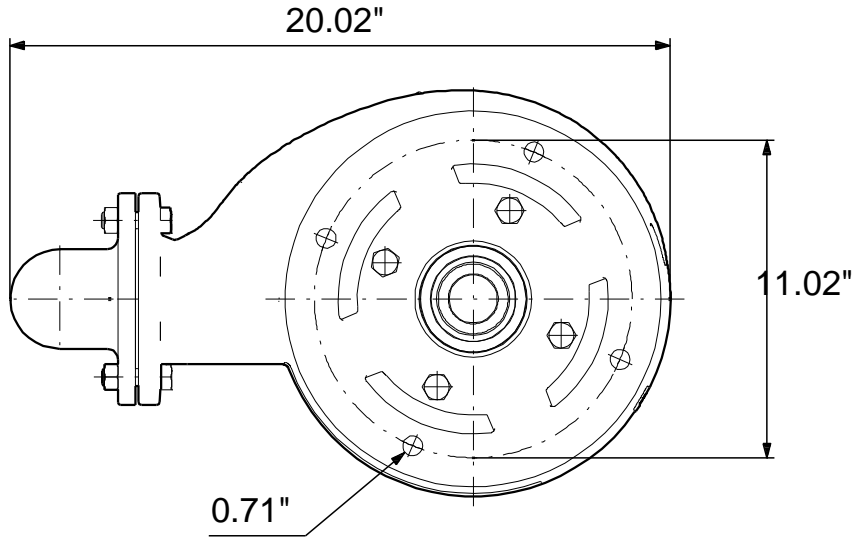

Note! All units are in [mm] unless otherwise stated.  
Disclaimer: This simplified dimensional drawing does not show all details.



## 98626169 SLV.65.65.22.A.2.50D.C 50 Hz

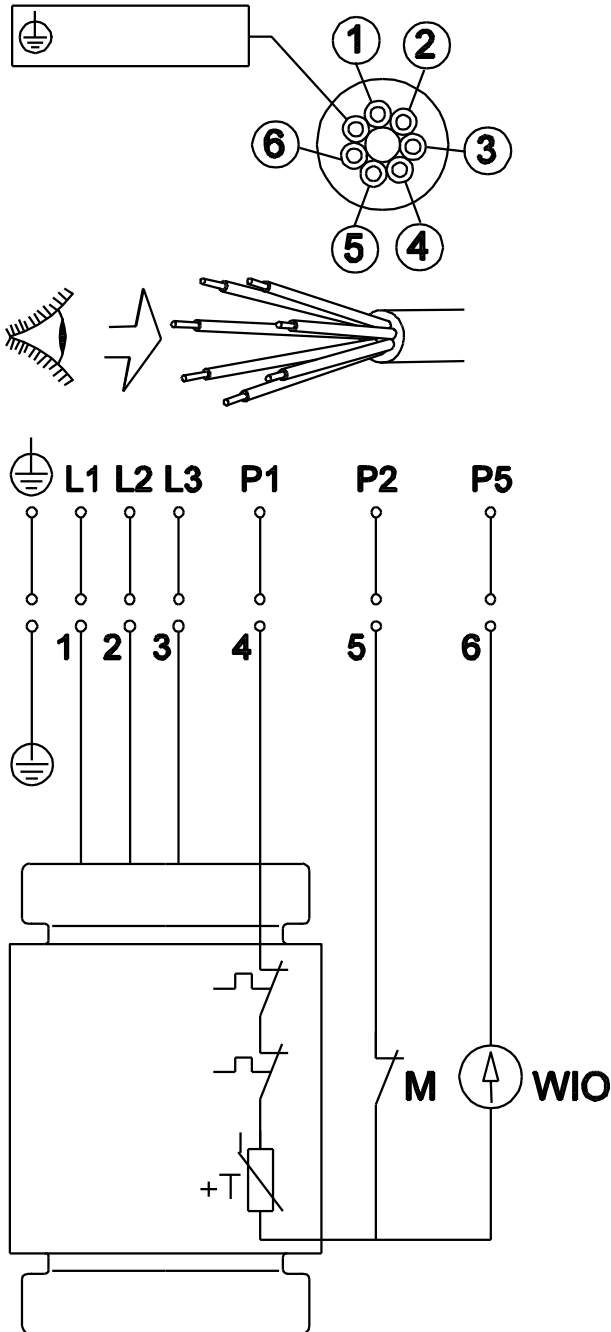

All units are [mm] unless otherwise presented.