

**Qty. Description**

1 MTR 3-25/25 A-W-A-HUUV



Product No.: [98511276](#)

Multistage, immersible, self-priming, centrifugal pump for vertical installation in tanks etc. The pump head and base are in cast iron – all other wetted parts are in stainless steel.

The pump has the following characteristics:

- Installation length according to DIN 5440.
- Impellers, intermediate chambers and spline shaft are made of Stainless steel.
- Mechanical shaft seal according to EN 12756.
- Power transmission via cast-iron split coupling.

A cartridge shaft seal ensures high reliability, safe handling, and easy access and service. The pump is fitted with a 3-phase, fan-cooled asynchronous motor.

**Controls:**

Frequency converter: NONE

**Liquid:**

Pumped liquid: Water  
 Liquid temperature range: -10 .. 90 °C  
 Selected liquid temperature: 20 °C  
 Density at selected liquid temperature: 998.2 kg/m<sup>3</sup>

**Technical:**

Pump speed on which pump data are based: 2899 rpm  
 Rated flow: 3 m<sup>3</sup>/h  
 Rated head: 122 m  
 Chambers: 25  
 Drainage back to tank: N  
 Pump orientation: Vertical  
 Code for shaft seal: HUUV  
 Curve tolerance: ISO9906:2012 3B

**Materials:**

Pump head: Cast iron  
 EN 1561 EN-GJL-200  
 ASTM A48-25B  
 Impeller: Stainless steel  
 EN 1.4301  
 AISI 304

**Installation:**

Maximum ambient temperature: 60 °C  
 Maximum operating pressure: 25 bar  
 Max pressure at stated temp: 25 bar / 90 °C  
 Type of connection: G  
 Size of outlet connection: 1 1/4 inch

Qty.	Description
	Immersion depth: 574 mm Flange size for motor: FT115  <b>Electrical data:</b> Motor standard: IEC Motor type: 90LC IE Efficiency class: IE3 Rated power - P2: 2.2 kW Mains frequency: 50 Hz Rated voltage: 3 x 220-240D/380-415Y V Rated current: 7.70/4.45 A Starting current: 850-950 % Cos phi - power factor: 0.89-0.87 Rated speed: 2890-2910 rpm Efficiency: IE3 85,9% Motor efficiency at full load: 85.9 % Motor efficiency at 3/4 load: 86.8 % Motor efficiency at 1/2 load: 86.0 % Number of poles: 2 Enclosure class (IEC 34-5): 55 Dust/Jetting Insulation class (IEC 85): F Motor No: 85U05908  <b>Others:</b> Terminal box position: 6 Minimum efficiency index, MEI : 0.70 Net weight: 28.4 kg Gross weight: 32.4 kg Shipping volume: 0.1 m <sup>3</sup> Country of origin: HU Custom tariff no.: 84137075

## 98511276 MTR 3-25/25 A-W-A-HUUV 50 Hz

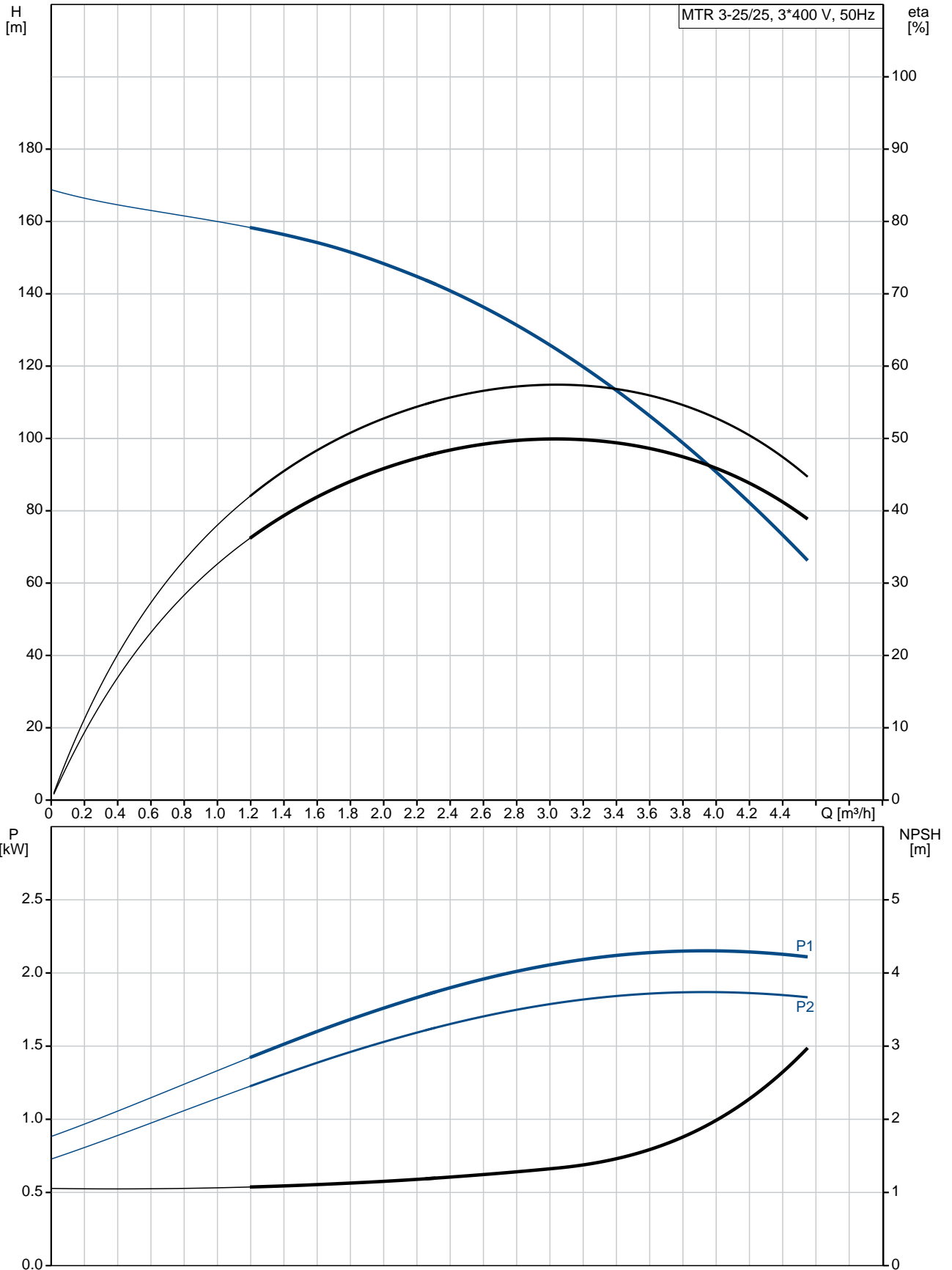

Description	Value
<b>General information:</b>	
Product name:	MTR 3-25/25 A-W-A-HUUV
Product No:	98511276
EAN number:	5711496360497
	5711496360497
Price:	1.648,00 GBP
<b>Technical:</b>	
Pump speed on which pump data are based:	2899 rpm
Rated flow:	3 m <sup>3</sup> /h
Rated head:	122 m
Chambers:	25
Impellers:	25
Number of reduced-diameter impellers:	0
Drainage back to tank:	N
Pump orientation:	Vertical
Code for shaft seal:	HUUV
Curve tolerance:	ISO9906:2012 3B
Pump version:	A
Model:	A
<b>Materials:</b>	
Pump head:	Cast iron
	EN 1561 EN-GJL-200
	ASTM A48-25B
Impeller:	Stainless steel
	EN 1.4301
	AISI 304
Material code:	A
<b>Installation:</b>	
Maximum ambient temperature:	60 °C
Maximum operating pressure:	25 bar
Max pressure at stated temp:	25 bar / 90 °C
Type of connection:	G
Size of outlet connection:	1 1/4 inch
Immersion depth:	574 mm
Flange size for motor:	FT115
Connect code:	W
<b>Liquid:</b>	
Pumped liquid:	Water
Liquid temperature range:	-10 .. 90 °C
Selected liquid temperature:	20 °C
Density at selected liquid temperature:	998.2 kg/m <sup>3</sup>
<b>Electrical data:</b>	
Motor standard:	IEC
Motor type:	90LC
IE Efficiency class:	IE3
Rated power - P2:	2.2 kW
Mains frequency:	50 Hz
Rated voltage:	3 x 220-240D/380-415Y V
Rated current:	7.70/4.45 A
Starting current:	850-950 %
Cos phi - power factor:	0.89-0.87
Rated speed:	2890-2910 rpm
Efficiency:	IE3 85,9%
Motor efficiency at full load:	85.9 %
Motor efficiency at 3/4 load:	86.8 %
Motor efficiency at 1/2 load:	86.0 %

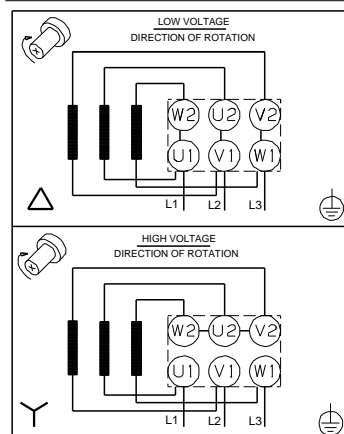
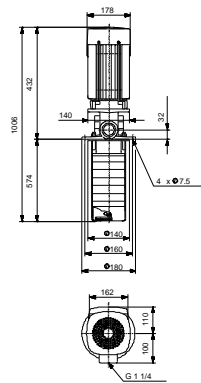
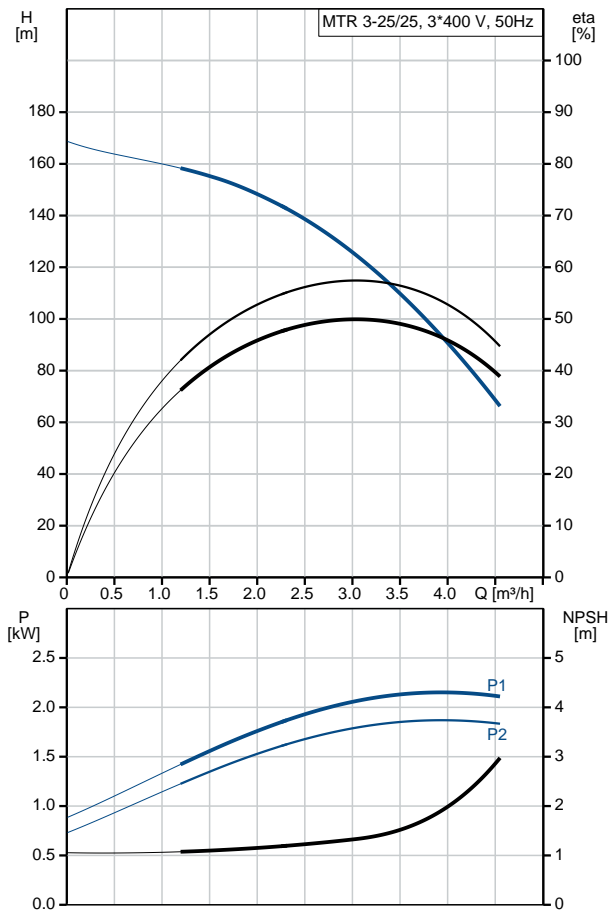



Company name:

Created by:

Phone:

Date:

15/10/2019

Description	Value
Number of poles:	2
Enclosure class (IEC 34-5):	55 Dust/Jetting
Insulation class (IEC 85):	F
Motor protec:	NONE
Motor No:	85U05908
<b>Controls:</b>	
Frequency converter:	NONE
<b>Others:</b>	
Terminal box position:	6
Minimum efficiency index, MEI :	0.70
Net weight:	28.4 kg
Gross weight:	32.4 kg
Shipping volume:	0.1 m <sup>3</sup>
Country of origin:	HU
Custom tariff no.:	84137075

## 98511276 MTR 3-25/25 A-W-A-HUUV 50 Hz

