

Position	Qty.	Description
	1	<p data-bbox="357 163 694 190">HYDRO MULTI-E 4 CRIE3-08</p>  <p data-bbox="746 434 1233 456" style="text-align: center;">Note! Product picture may differ from actual product</p> <p data-bbox="357 465 624 488">Product No.: 98486680</p> <p data-bbox="357 524 1401 577">GRUNDFOS Hydro Multi-E booster sets are designed for the transfer and pressure boosting of clean water in waterworks, blocks of flats, hotels, industry, hospitals, schools, etc.</p> <p data-bbox="357 584 1385 638">GRUNDFOS Hydro Multi-E booster set consists of 2 to 4 CRIE pumps coupled in parallel and mounted on a common base frame provided with all the necessary fittings.</p> <p data-bbox="357 669 1449 824">Hydro Multi-E is mounted on a common base frame made of stainless steel (DIN W.-Nr. 1.4301). On the suction side are fitted a suction manifold (DIN W.-Nr. 1.4401 or DIN W.-Nr. 1.4571) , a pressure switch mounted on a drainable valve and an isolating valve. On the discharge side of the pumps are fitted a non-return valve, an isolating valve, a pressure gauge, two pressure transmitters mounted on a drainable valve a diaphragm tank and a stainless steel discharge manifold (DIN W.-Nr. 1.4401 or DIN W.-Nr. 1.4571).</p> <p data-bbox="357 840 1125 869">The Hydro Multi-E is fitted with an on/off-switch for the supply voltage.</p> <p data-bbox="357 900 1437 954">The Hydro Multi-E is designed for maintaining a constant pressure regardless of flow changes and fluctuation.</p> <p data-bbox="357 985 1385 1039">The internal PI-controller regulates the number of running pumps and the speed of the pumps according to the required flow.</p> <p data-bbox="357 1070 1348 1124">The system can be operated directly on the panel of any of the pumps or via Grundfos GO (available as accessory)</p> <p data-bbox="357 1155 1018 1429">Besides the system features: 2 Digital outputs 2 Digital inputs (one used for dry run protection) 2 Analogue inputs (one used for discharge pressure sensor) Multi-Master functionality 2 Limit functions Set-point influence function Pipe filling function High efficient PM motors</p> <p data-bbox="357 1460 746 1765">Available communication protocols: •LON •Profibus •Modbus •SMS/GSM/GPRS •GRM •BACnet •BACnet IP •Modbus TCP •PROFINET</p> <p data-bbox="357 1796 1348 1850">When delivered, the GRUNDFOS Hydro Multi-E booster set is factory tested and ready for operation.</p> <p data-bbox="357 1908 853 2065">Liquid: Pumped liquid: Water Liquid temperature range: 5 .. 60 °C Liquid temperature during operation: 20 °C Density: 998.2 kg/m³</p>

Position	Qty.	Description
		<p>Materials: Pump housing: Stainless steel</p> <p>Installation: Maximum operating pressure: 10 bar Maximum inlet pressure: PN 10 bar Flange standard: DIN ISO 7/1 Manifold inlet: R 2 1/2 Manifold outlet: R 2 1/2</p> <p>Electrical data: IE Efficiency class: IE5 Power (P2) main pump: 1.1 kW Mains frequency: 50 Hz Rated voltage: 3 x 380-415 V Phase main pump: 1 Rated current: 11.4 A Start. method: electronically Enclosure class (IEC 34-5): IP54</p> <p>Tank: Volume of pressure tank: 8 l Diaphragm tank: Yes</p> <p>Others: Net weight: 163 kg Gross weight: 175 kg Shipping volume: 0.6 m³ Language: GB</p>

98486680 HYDRO MULTI-E 4 CRIE3-08 50 Hz

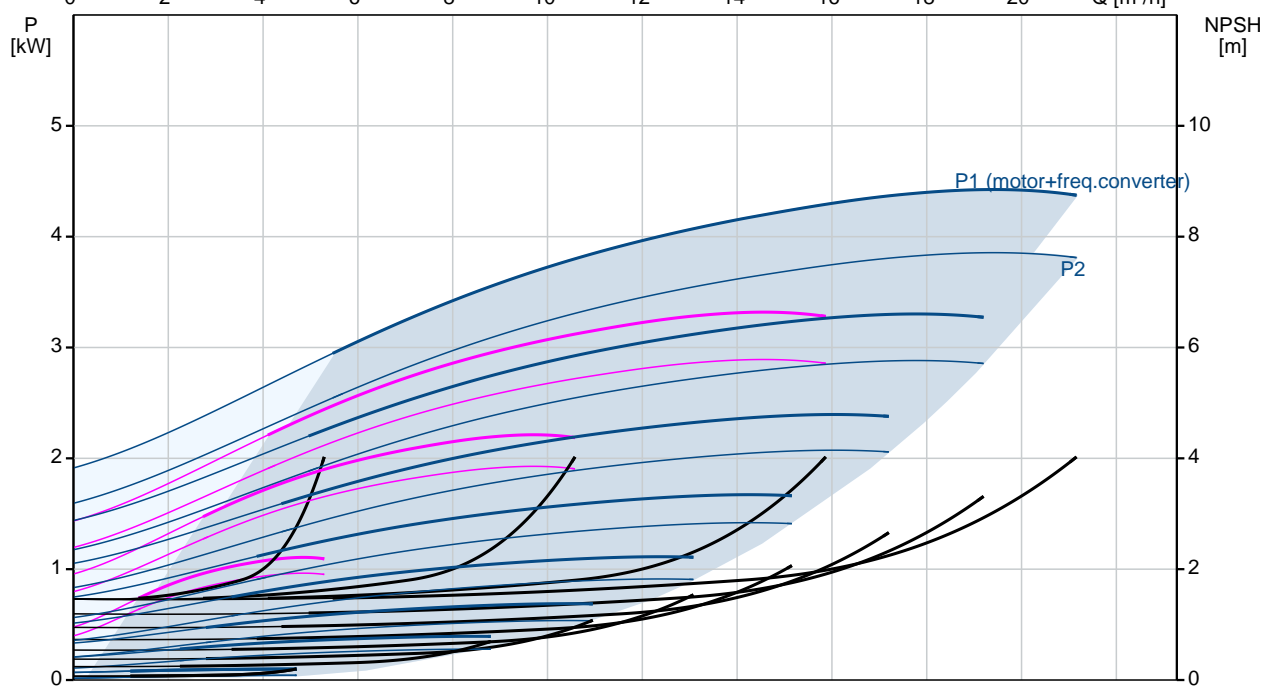
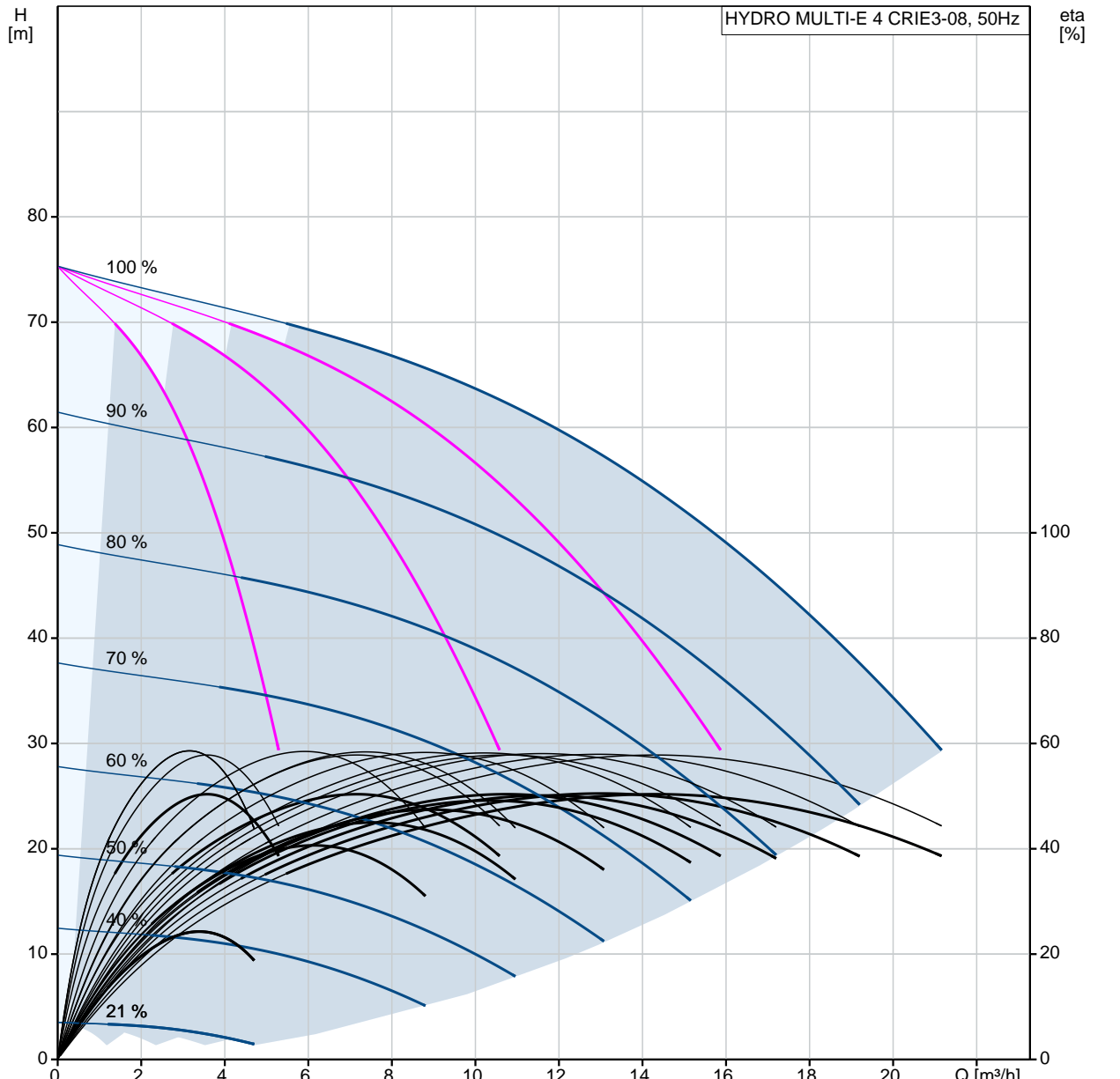

Description	Value
General information:	
Product name:	HYDRO MULTI-E 4 CRIE3-08
Product No:	98486680
EAN number:	5711495953478
Technical:	
Min flow system:	0.35 m ³ /h
Max flow:	21.6 m ³ /h
Head max:	74 m
Pump name:	CRIE3-08
Number of pumps:	4
Materials:	
Pump housing:	Stainless steel
Manifolds:	Stainless steel
Installation:	
Maximum operating pressure:	10 bar
Maximum inlet pressure:	PN 10 bar
Flange standard:	DIN ISO 7/1
Manifold inlet:	R 2 1/2
Manifold outlet:	R 2 1/2
Liquid:	
Pumped liquid:	Water
Liquid temperature range:	5 .. 60 °C
Liquid temperature during operation:	20 °C
Density:	998.2 kg/m ³
Electrical data:	
IE Efficiency class:	IE5
Power (P2) main pump:	1.1 kW
Mains frequency:	50 Hz
Rated voltage:	3 x 380-415 V
Phase main pump:	1
Rated current:	11.4 A
Start. method:	electronically
Enclosure class (IEC 34-5):	IP54
Tank:	
Volume of pressure tank:	8 l
Diaphragm tank:	Yes
Others:	
Net weight:	163 kg
Gross weight:	175 kg
Shipping volume:	0.6 m ³
Language:	GB
Product range:	International

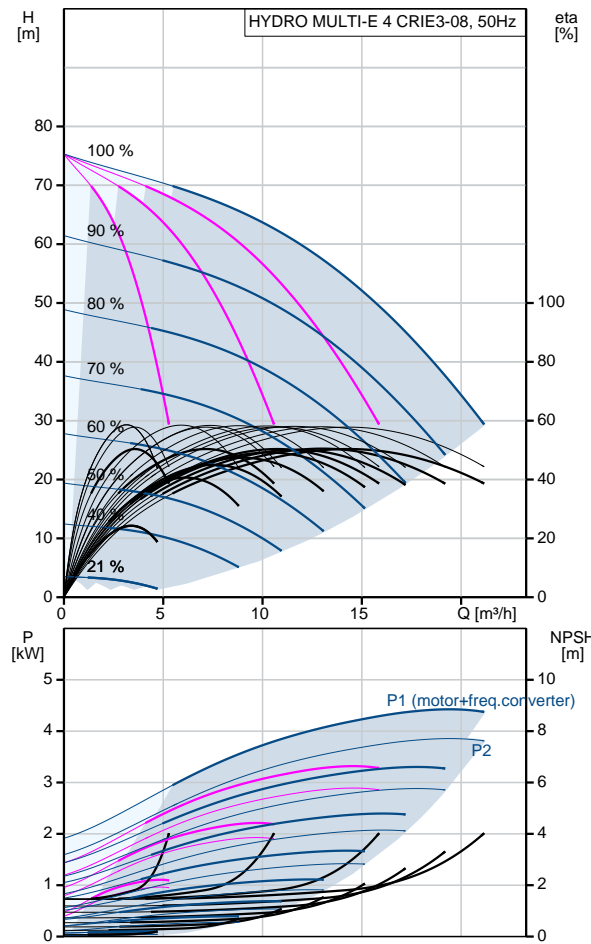

98486680 HYDRO MULTI-E 4 CRIE3-08 50 Hz

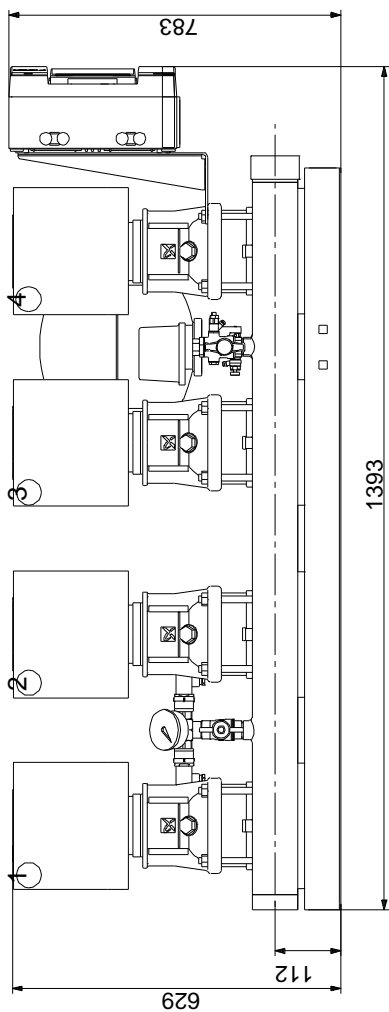
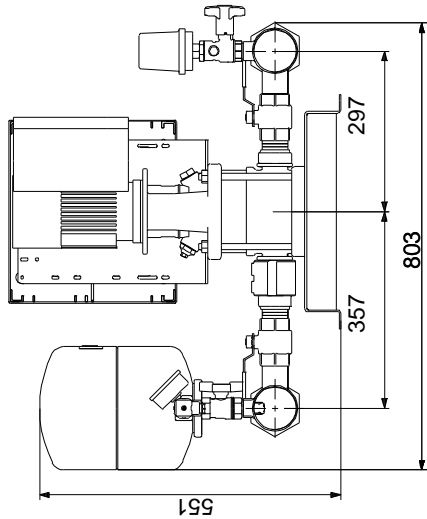

Note! All units are in [mm] unless others are stated.
Disclaimer: This simplified dimensional drawing does not show all details.

98486680 HYDRO MULTI-E 4 CRIE3-08 50 Hz

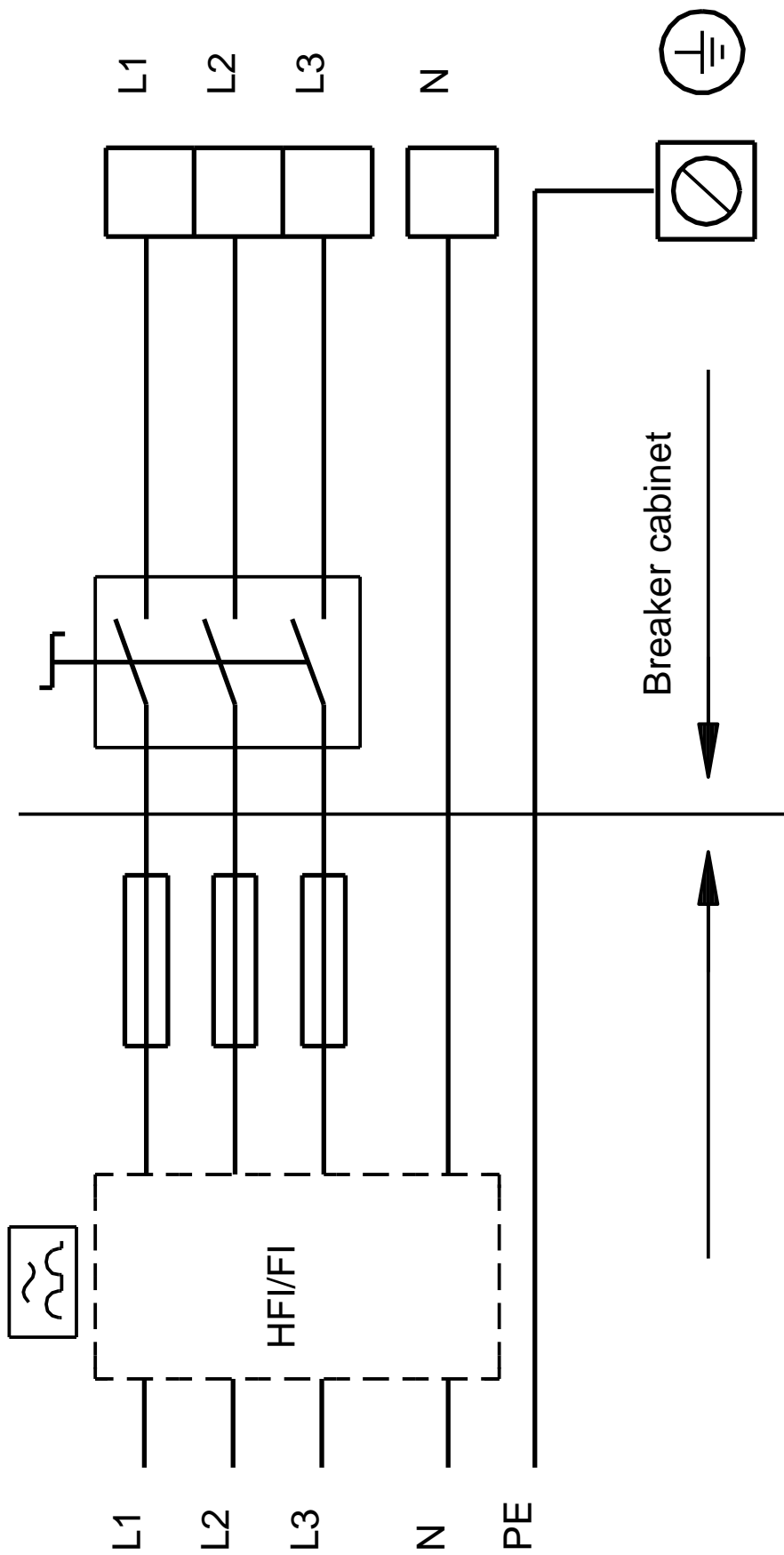

Note! All units are in [mm] unless others are stated.