

Qty. Description

1 NB 50-160/175 AF2ABQQE

Product No.: [98366433](#)

Non-self-priming, single-stage, centrifugal volute pump designed according to ISO 5199 with dimensions and rated performance according to EN 733 (10 bar).

Flanges are PN 16 with dimensions according to EN 1092-2. The pump has an axial suction port, radial discharge port, horizontal shaft and a back pull-out design enabling removal of the motor, motor stool, cover and impeller without disturbing the pump housing or pipework.

The unbalanced rubber bellows seal is according to DIN EN 12756.

The pump is close-coupled to a fan-cooled asynchronous motor.

The product's minimum efficiency index (MEI) is greater or equal to 0.70. This is by the Commission Regulation (EU) considered as an indicative benchmark for best-performing water pump available on the market as from 1 January 2013.

The back pull-out design means that the pump can be serviced by a single person without disturbing the pump housing or pipes.

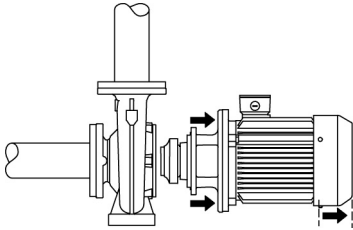

Cast-iron parts have an epoxy-based coating made in a cathodic electro-deposition (CED) process. CED is a high-quality dip-painting process where an electrical field around the products ensures deposition of paint particles as a thin, well-controlled layer on the surface.

Pump

The pump housing has both a priming and a drain hole closed by plugs. The impeller is a closed impeller with double-curved blades with smooth surfaces. The impeller is statically balanced according to ISO 1940-1 class G6.3 and hydraulically balanced to compensate for axial thrust.

Wear rings used in pump housing and for impeller are made of bronze/brass.

Motor stool and pump cover are made of cast iron (EN-GJL-250). Coupling guards are fitted to the motor stool. The pump cover is provided with a manual air vent screw for venting of the pump housing and the shaft seal chamber.

The pump is fitted with an unbalanced rubber bellows seal with torque transmission across the spring and around the bellows. Due to the bellows, the seal does not wear the shaft, and the axial movement is not prevented by deposits on the shaft.

Primary seal:

- Rotating seal ring material: silicon carbide (SiC)
- Stationary seat material: silicon carbide (SiC)

This material pairing is used where higher corrosion resistance is required. The high hardness of this material pairing offers good resistance against abrasive particles.

Secondary seal material: EPDM (ethylene-propylene rubber)

EPDM has excellent resistance to hot water. EPDM is not suitable for mineral oils.

The pump housing has feet.

Motor

Qty. Description

The motor is a totally enclosed, fan-cooled motor with principal dimensions to IEC and DIN standards. Electrical tolerances comply with IEC 60034.

The motor efficiency is classified as IE3 in accordance with IEC 60034-30-1.

The motor does not incorporate motor protection and must be connected to a motor-protective circuit breaker which can be manually reset. The motor-protective circuit breaker must be set according to the rated current of the motor (I1/1).

The motor can be connected to a variable speed drive for adjustment of pump performance to any duty point. Grundfos CUE offers a range of variable speed drives. Please find more information in Grundfos Product Center.

Further product details
Technical data
Controls:

Frequency converter: NONE

Pressure sensor: N

Liquid:

Pumped liquid: Water

Liquid temperature range: -25 .. 120 °C

Selected liquid temperature: 20 °C

Density: 998.2 kg/m³

Technical:

Pump speed on which pump data are based: 1445 rpm

Rated flow: 45.04 m³/h

Rated head: 9.137 m

Actual impeller diameter: 175 mm

Nominal impeller diameter: 160

Shaft seal arrangement: Single

Code for shaft seal: BQQE

Curve tolerance: ISO9906:2012 3B2

Bearing design: Standard

Materials:

Pump housing: Cast iron
EN-GJL-250
ASTM class 35

Wear ring: Brass

Impeller: Cast iron
EN-GJL-200
ASTM class 30

Shaft: Stainless steel
EN 1.4301
AISI 304

Internal pump house coating: CED

Installation:

Maximum ambient temperature: 55 °C

Maximum operating pressure: 16 bar

Pipe connection standard: EN 1092-2

Size of inlet connection: DN 65

Size of outlet connection: DN 50

Pressure rating for connection: PN 16

Qty.	Description
	<p>Bearing lubrication: Grease</p> <p>Pump housing with feet: Yes</p> <p>Support block: N</p> <p>Electrical data:</p> <p>Motor type: SIEMENS</p> <p>IE Efficiency class: IE3</p> <p>Rated power - P2: 1.5 kW</p> <p>Mains frequency: 50 Hz</p> <p>Rated voltage: 3 x 220-240D/380-420Y V</p> <p>Rated current: 5,78-5,23/3,31-2,99 A</p> <p>Starting current: 720-720 %</p> <p>Cos phi - power factor: 0.8</p> <p>Rated speed: 1445 rpm</p> <p>Efficiency: IE3 85,3%</p> <p>Motor efficiency at full load: 85.3-85.3 %</p> <p>Motor efficiency at 3/4 load: 86.0-86.0 %</p> <p>Motor efficiency at 1/2 load: 85.2-85.2 %</p> <p>Number of poles: 4</p> <p>Enclosure class (IEC 34-5): IP55</p> <p>Insulation class (IEC 85): F</p> <p>Motor No: 83V02206</p> <p>Others:</p> <p>Minimum efficiency index, MEI ≥: 0.70</p> <p>Net weight: 49 kg</p> <p>Gross weight: 59 kg</p> <p>Shipping volume: 0.178 m³</p> <p>Country of origin: HU</p> <p>Custom tariff no.: 84137051</p>

98366433 NB 50-160/175 AF2ABQQE 50 Hz

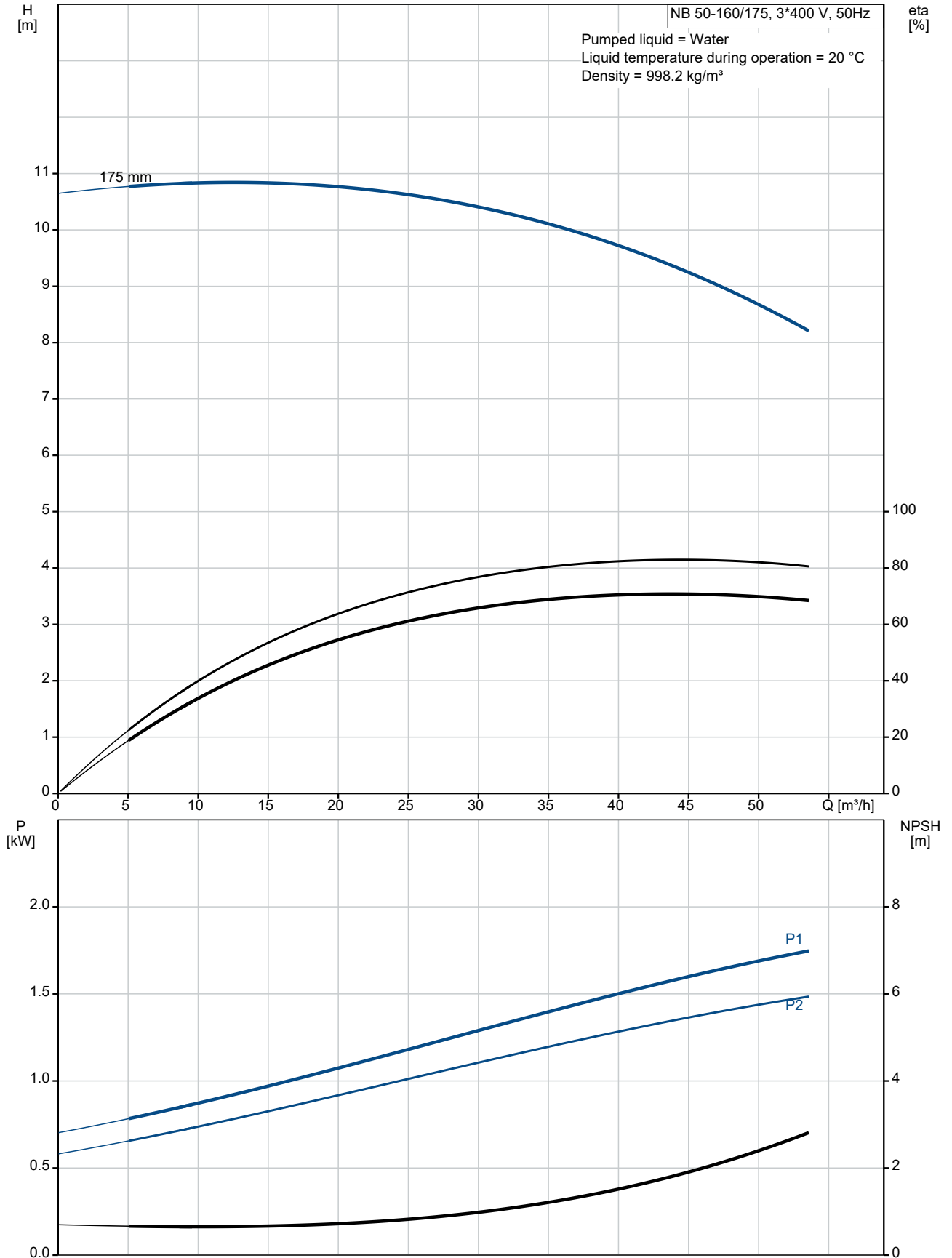

Description	Value
General information:	
Product name:	NB 50-160/175 AF2ABQQE
Product No:	98366433
EAN number:	5711493755661
Price:	GBP 1580
Technical:	
Pump speed on which pump data are based:	1445 rpm
Rated flow:	45.04 m ³ /h
Rated head:	9.137 m
Actual impeller diameter:	175 mm
Nominal impeller diameter:	160
Shaft seal arrangement:	Single
Shaft diameter:	24 mm
Code for shaft seal:	BQQE
Curve tolerance:	ISO9906:2012 3B2
Pump version:	A
Bearing design:	Standard
Materials:	
Pump housing:	Cast iron
Pump housing:	EN-GJL-250
Pump housing:	ASTM class 35
Wear ring:	Brass
Impeller:	Cast iron
Impeller:	EN-GJL-200
Impeller:	ASTM class 30
Shaft:	Stainless steel
Shaft:	EN 1.4301
Shaft:	AISI 304
Internal pump house coating:	CED
Material code:	A
Code for rubber:	E
Installation:	
Maximum ambient temperature:	55 °C
Maximum operating pressure:	16 bar
Pipe connection standard:	EN 1092-2
Size of inlet connection:	DN 65
Size of outlet connection:	DN 50
Pressure rating for connection:	PN 16
Bearing lubrication:	Grease
Pump housing with feet:	Yes
Support block:	N
Connect code:	F2
Liquid:	
Pumped liquid:	Water
Liquid temperature range:	-25 .. 120 °C
Selected liquid temperature:	20 °C
Density:	998.2 kg/m ³
Electrical data:	
Motor type:	SIEMENS
IE Efficiency class:	IE3
Rated power - P2:	1.5 kW
Mains frequency:	50 Hz
Rated voltage:	3 x 220-240D/380-420Y V
Rated current:	5,78-5,23/3,31-2,99 A
Starting current:	720-720 %
Cos phi - power factor:	0.8

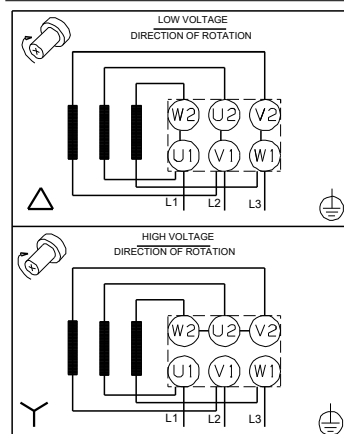
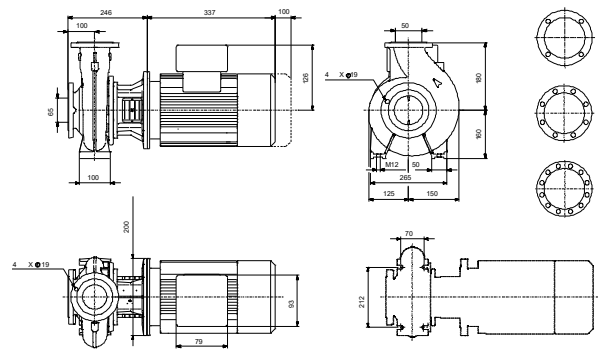
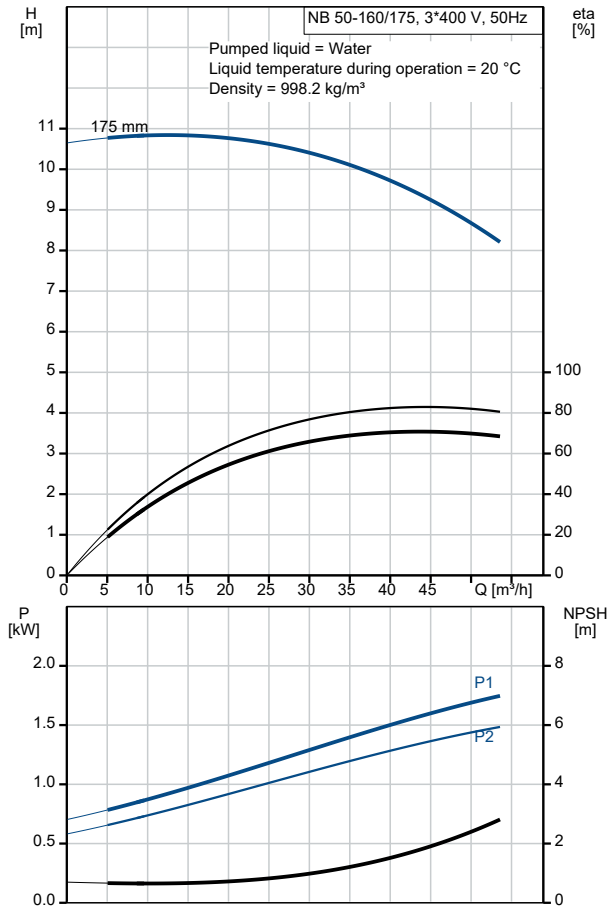



Company name:

Created by:

Phone:

Date:

12/08/2021

Description	Value
Rated speed:	1445 rpm
Efficiency:	IE3 85,3%
Motor efficiency at full load:	85.3-85.3 %
Motor efficiency at 3/4 load:	86.0-86.0 %
Motor efficiency at 1/2 load:	85.2-85.2 %
Number of poles:	4
Enclosure class (IEC 34-5):	IP55
Insulation class (IEC 85):	F
Motor protec:	NONE
Motor No:	83V02206
Mount. design. acc. IEC 34-7:	IM V1
Controls:	
Frequency converter:	NONE
Pressure sensor:	N
Others:	
Minimum efficiency index, MEI ≥:	0.70
Net weight:	49 kg
Gross weight:	59 kg
Shipping volume:	0.178 m ³
Country of origin:	HU
Custom tariff no.:	84137051

98366433 NB 50-160/175 AF2ABQQE 50 Hz

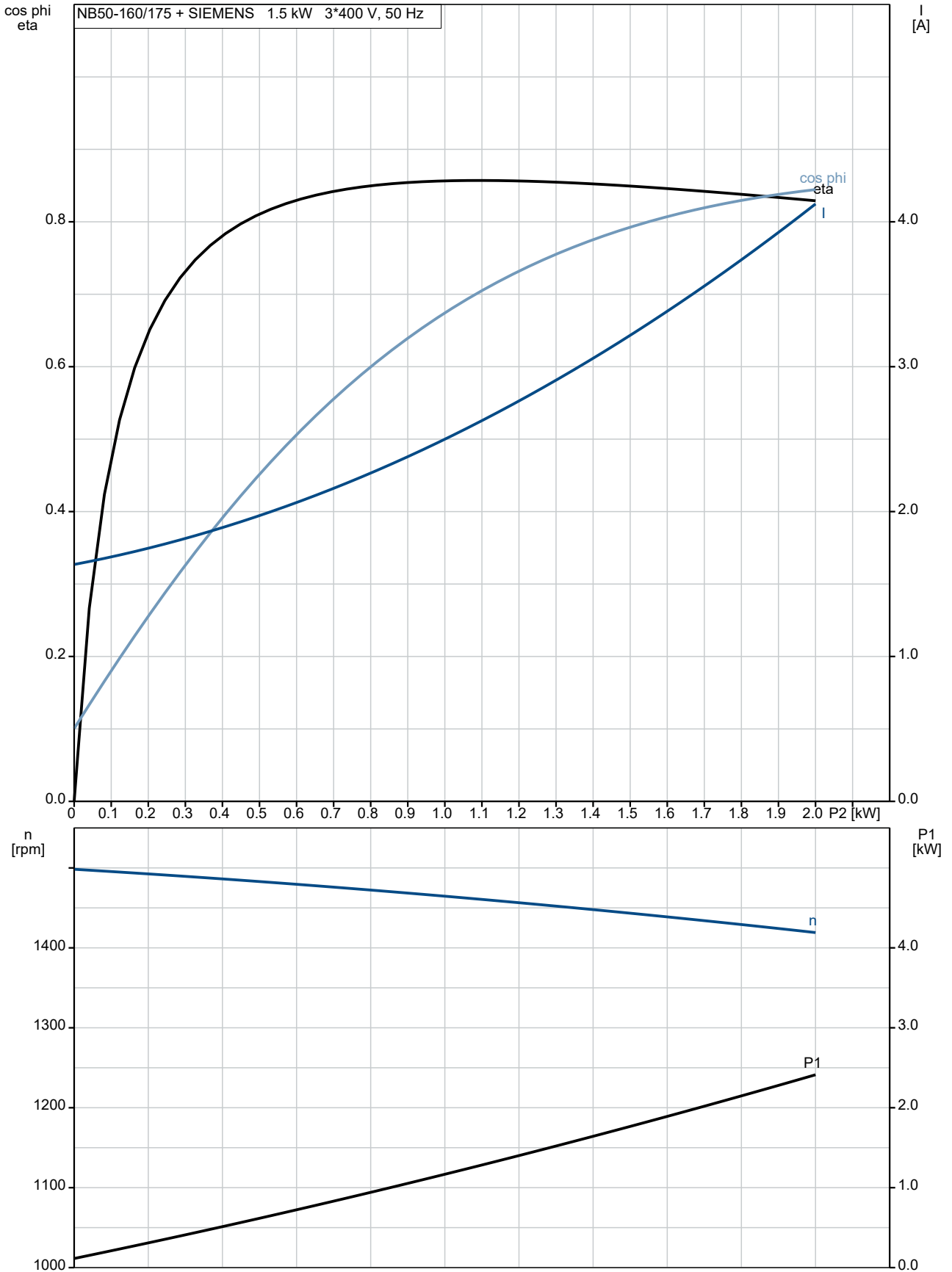

98366433 NB 50-160/175 AF2ABQQE 50 Hz

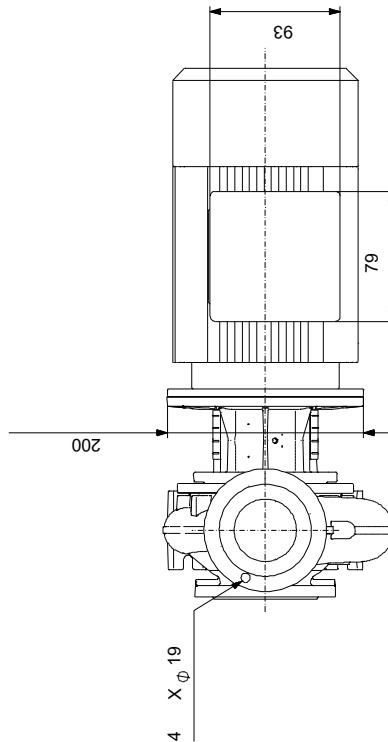
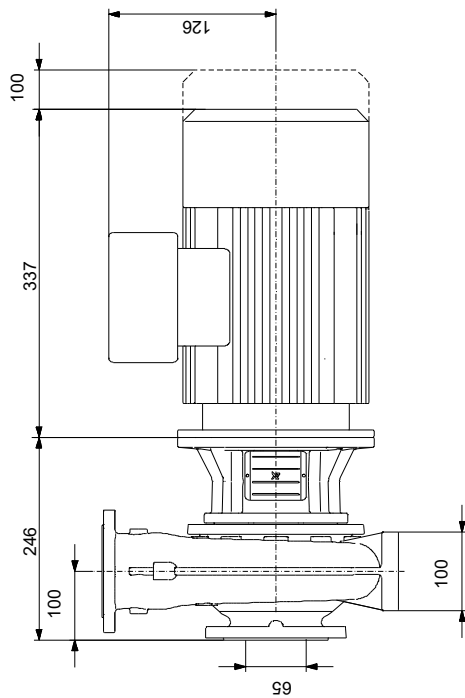
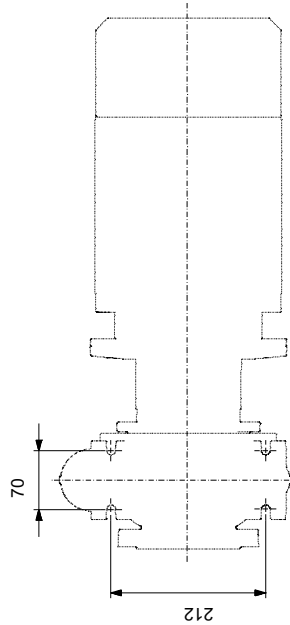
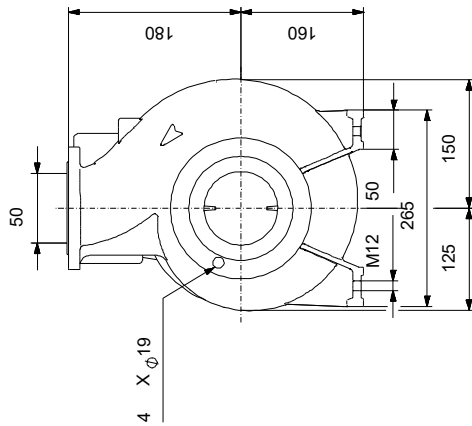

Note! All units are in [mm] unless others are stated.
Disclaimer: This simplified dimensional drawing does not show all details.

98366433 NB 50-160/175 AF2ABQQE 50 Hz

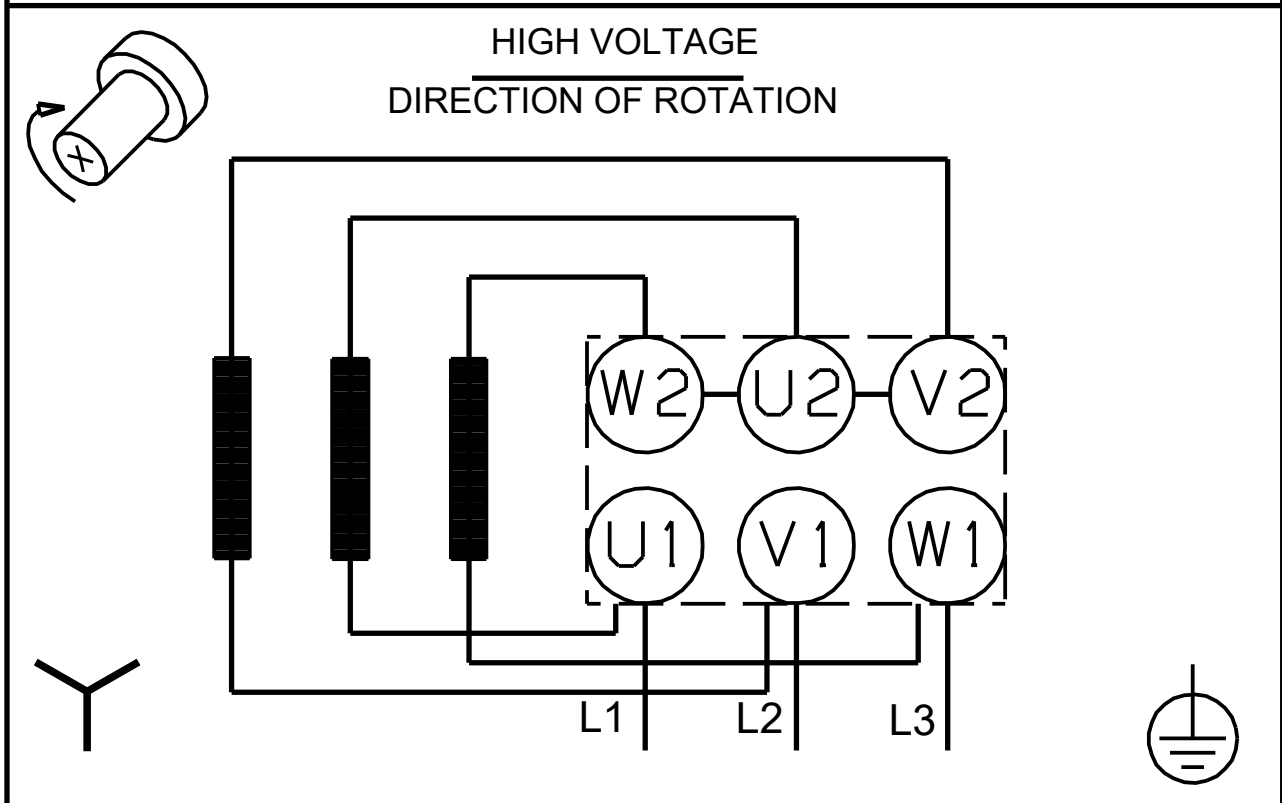
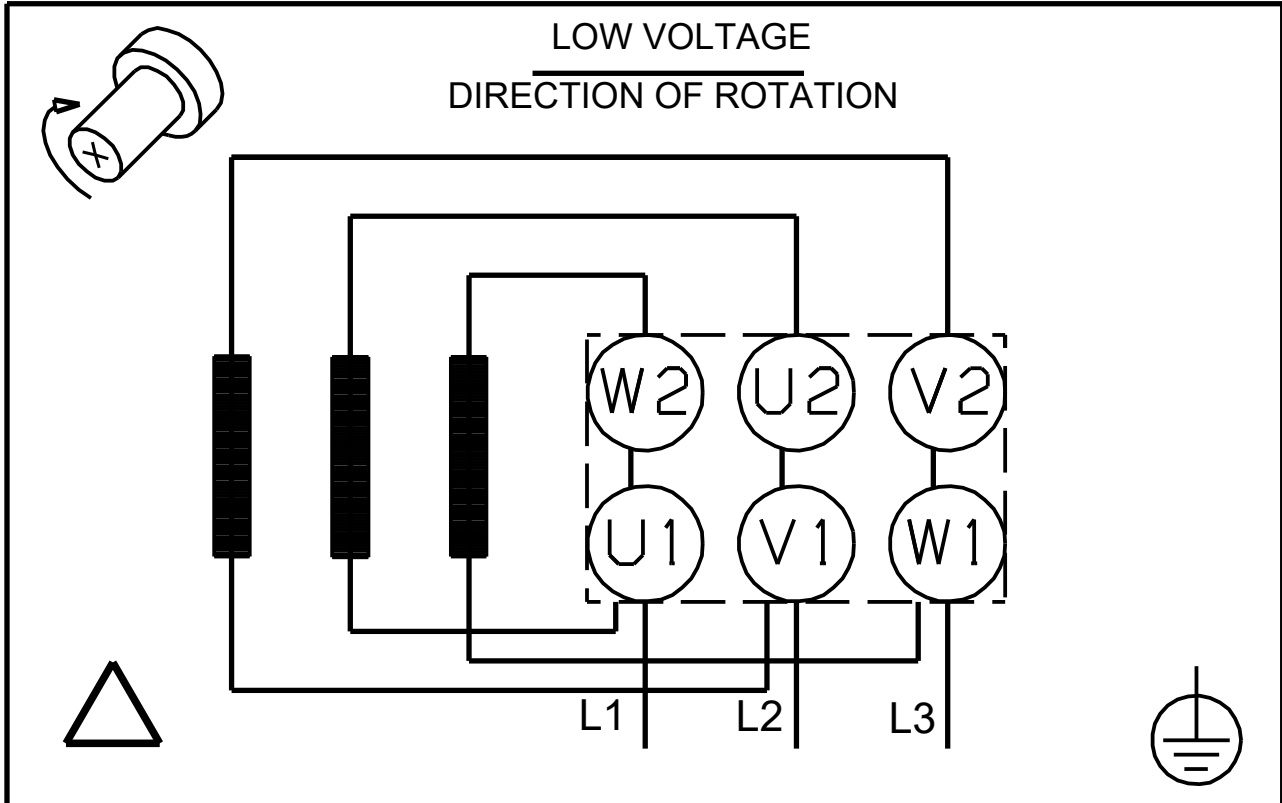

Note! All units are in [mm] unless others are stated.