

**Qty. Description**

1 MTA 90-130 A-W-A-T



Note! Product picture may differ from actual product

Product No.: [97989245](#)

Low pressure immersible centrifugal pump for installation, in filtering systems or conveyer systems in the machine tool industry.

The pump has the following characteristics:

- The pump is closed-coupled without shaft seal.

Phase: - The pump is fitted with a 3-phase integrated motor.

- Open impeller allows particles to pass through pump

Impeller: - Impeller is made of PAA GF50.

- Motor stool and pump housing are made of cast iron.

- The pump has no wearing parts.

Immersion depth: 128 mmmm

Liquid:

Pumped liquid: Water

Liquid temperature range: 0 .. 60 °C

Selected liquid temperature: 20 °C

Density: 998.2 kg/m<sup>3</sup>

Technical:

Rated flow: 80 l/min

Rated head: 4.7 m

Approvals on nameplate: CE

Cable entry: 22

Materials:

Pump housing: Cast iron  
DIN W.-Nr. GG20  
ASTM A48-CL30

Impeller: PAA GF50

Installation:

Maximum ambient temperature: 40 °C

Pump outlet: G 3/4

Port-to-port length: 128 mm

Electrical data:

Power input - P1: 270 W

Mains frequency: 50 Hz



Company name:

Created by:

Phone:

Date:

02/02/2021

Qty.	Description
	<p data-bbox="201 342 880 577">Rated voltage: 3 x 220-240 D / 380-415 Y V Service factor: 1.15 Rated current: 0.97/0.55 A Starting current: 480 % Rated speed: 2933 rpm Motor efficiency at full load: 79.4 % Enclosure class (IEC 34-5): IP54 Insulation class (IEC 85): F</p> <p data-bbox="201 611 667 725">Others: Net weight: 12.6 kg Gross weight: 14.2 kg Shipping volume: 0.017 m<sup>3</sup></p>

## 97989245 MTA 90-130 A-W-A-T 50 Hz

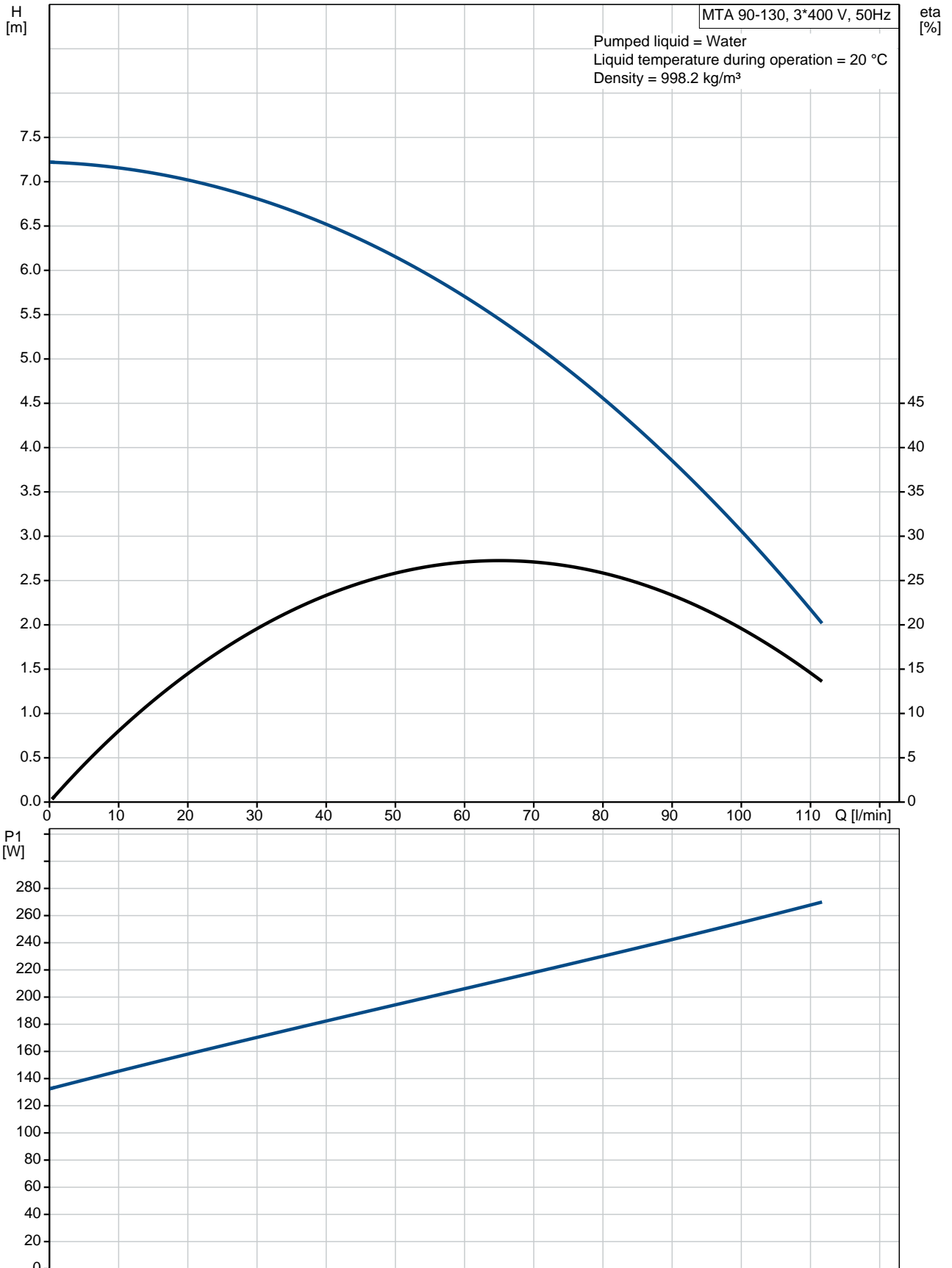

Description	Value
<b>General information:</b>	
Product name:	MTA 90-130 A-W-A-T
Product No:	97989245
EAN number:	5710627481476
Price:	
<b>Technical:</b>	
Rated flow:	80 l/min
Rated head:	4.7 m
Maximum head:	7.3 m
Head max:	7.3 m
Approvals on nameplate:	CE
Pump version:	A
Model:	A
Cable entry:	22
<b>Materials:</b>	
Pump housing:	Cast iron
Pump housing:	DIN W.-Nr. GG20
Pump housing:	ASTM A48-CL30
Impeller:	PAA GF50
Material code:	A
<b>Installation:</b>	
Maximum ambient temperature:	40 °C
Pump outlet:	G 3/4
Port-to-port length:	128 mm
Connect code:	W
<b>Liquid:</b>	
Pumped liquid:	Water
Liquid temperature range:	0 .. 60 °C
Selected liquid temperature:	20 °C
Density:	998.2 kg/m <sup>3</sup>
<b>Electrical data:</b>	
Power input - P1:	270 W
Mains frequency:	50 Hz
Rated voltage:	3 x 220-240 D / 380-415 Y V
Service factor:	1.15
Rated current:	0.97/0.55 A
Starting current:	480 %
Rated speed:	2933 rpm
Motor efficiency at full load:	79.4 %
Enclosure class (IEC 34-5):	IP54
Insulation class (IEC 85):	F
Motor protec:	NO
<b>Controls:</b>	
Pos term box:	9
<b>Others:</b>	
Net weight:	12.6 kg
Gross weight:	14.2 kg
Shipping volume:	0.017 m <sup>3</sup>

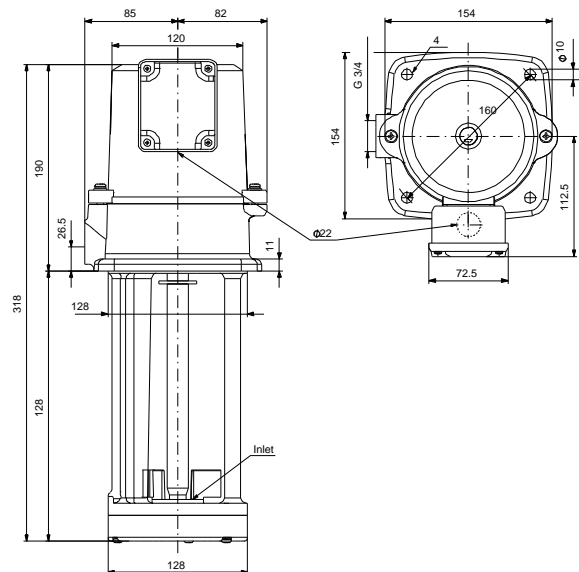
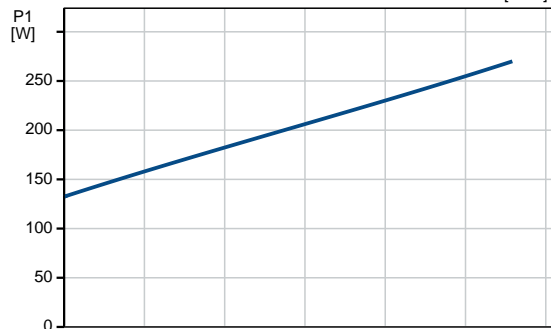
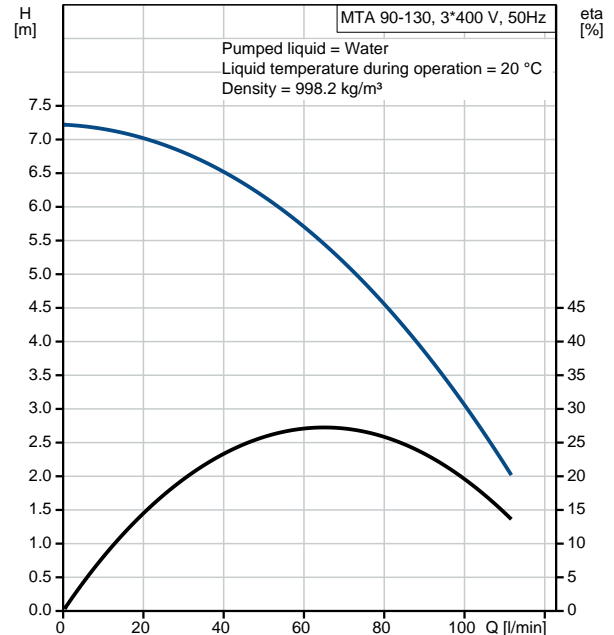

## 97989245 MTA 90-130 A-W-A-T 50 Hz

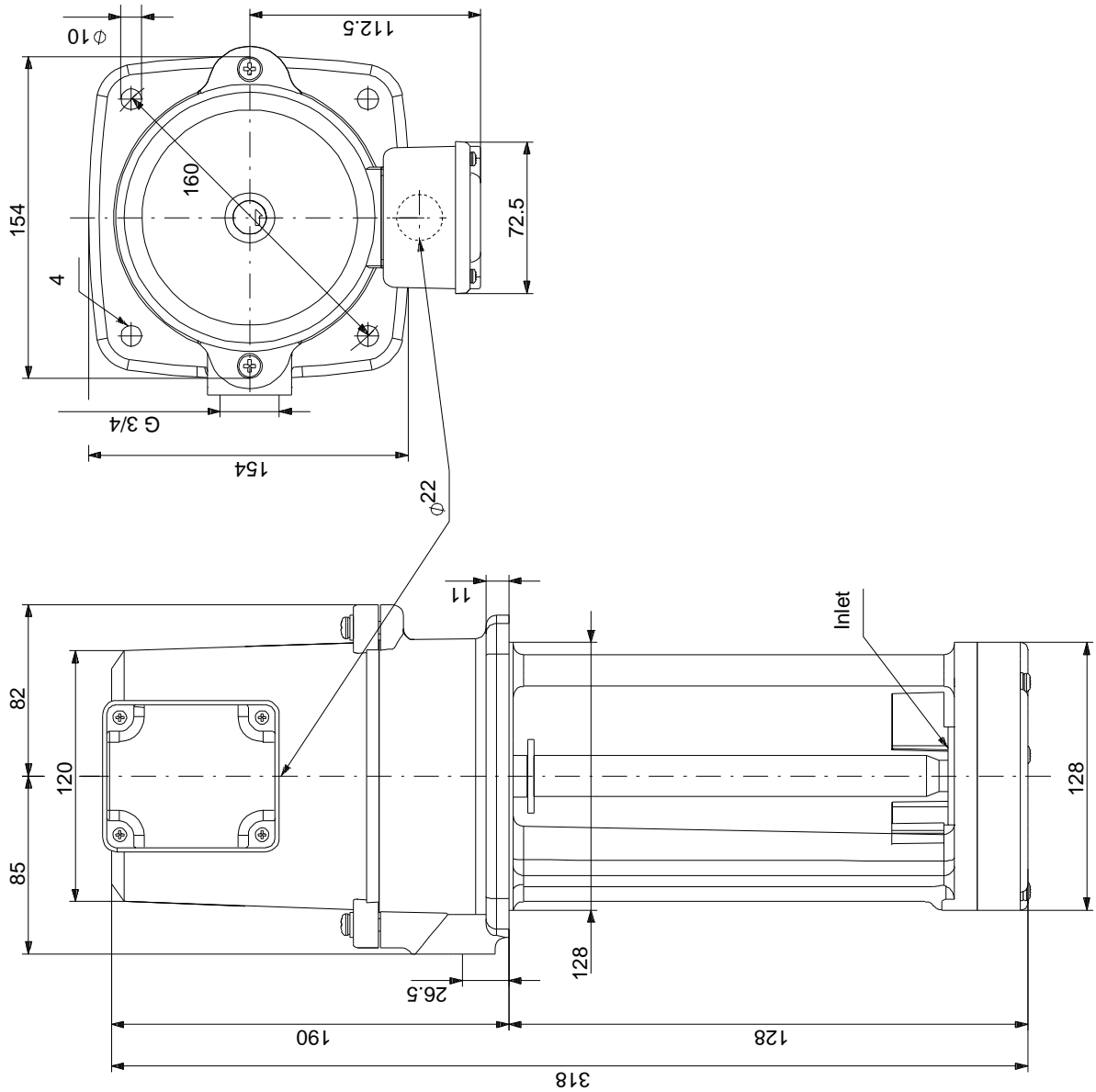

Note! All units are in [mm] unless others are stated.  
Disclaimer: This simplified dimensional drawing does not show all details.