

Position	Qty.	Description
	1	<p>TP 200-150/4 A-F-A-BQQE</p>  <p>Product No.: 97927150</p> <p>Single-stage, close-coupled, volute pump with in-line suction and discharge ports of identical diameter. The pump is of the top-pull-out design, i.e. the power head (motor, pump head and impeller) can be removed for maintenance or service while the pump housing remains in the pipework.</p> <p>The pump is fitted with an unbalanced rubber bellows seal. The shaft seal is according to EN 12756. Pipework connection is via PN 16 DIN flanges (EN 1092-2 and ISO 7005-2).</p> <p>The pump is fitted with a fan-cooled asynchronous motor.</p> <p>Liquid: Pumped liquid: Water Liquid temperature range: -25 .. 120 °C Liquid temperature during operation: 20 °C Density: 998.2 kg/m³</p> <p>Technical: Speed for pump data: 1470 rpm Rated flow: 396 m³/h Rated head: 9.6 m Actual impeller diameter: 224 mm Primary shaft seal: BQQE Curve tolerance: ISO9906:2012 3B</p> <p>Materials: Pump housing: Cast iron EN-JL1040 ASTM A48-40 B Impeller: Cast iron EN-JL1030 ASTM A48-30 B</p> <p>Installation: Range of ambient temperature: -30 .. 60 °C Maximum operating pressure: 16 bar Flange standard: DIN Pipe connection: DN 200 Pump inlet: DN 200 Pump outlet: DN 200 Pressure stage: PN 16 Port-to-port length: 900 mm Flange size for motor: FF300</p> <p>Electrical data: Motor type: 160LB IE Efficiency class: IE3 Rated power - P2: 15 kW Power (P2) required by pump: 15 kW Mains frequency: 50 Hz</p>

Position	Qty.	Description
		<p>Rated voltage: 3 x 380-415D/660-690Y V</p> <p>Rated current: 29,0-28,0/16,8-16,4 A</p> <p>Starting current: 760-870 %</p> <p>Cos phi - power factor: 0,86-0,82</p> <p>Rated speed: 1460-1470 rpm</p> <p>Efficiency: IE3 92,1%</p> <p>Motor efficiency at full load: 92.1 %</p> <p>Motor efficiency at 3/4 load: 92.3 %</p> <p>Motor efficiency at 1/2 load: 92.1 %</p> <p>Number of poles: 4</p> <p>Enclosure class (IEC 34-5): 55 Dust/Jetting</p> <p>Insulation class (IEC 85): F</p> <p>Others:</p> <p>Label: Grundfos Blueflux</p> <p>Minimum efficiency index, MEI : 0.70</p> <p>ErP status: EuP Standalone/Prod.</p> <p>Net weight: 383 kg</p> <p>Gross weight: 479 kg</p> <p>Shipping volume: 2.29 m³</p> <p>Danish: VVS NO 381719150</p>

97927150 TP 200-150/4 50 Hz

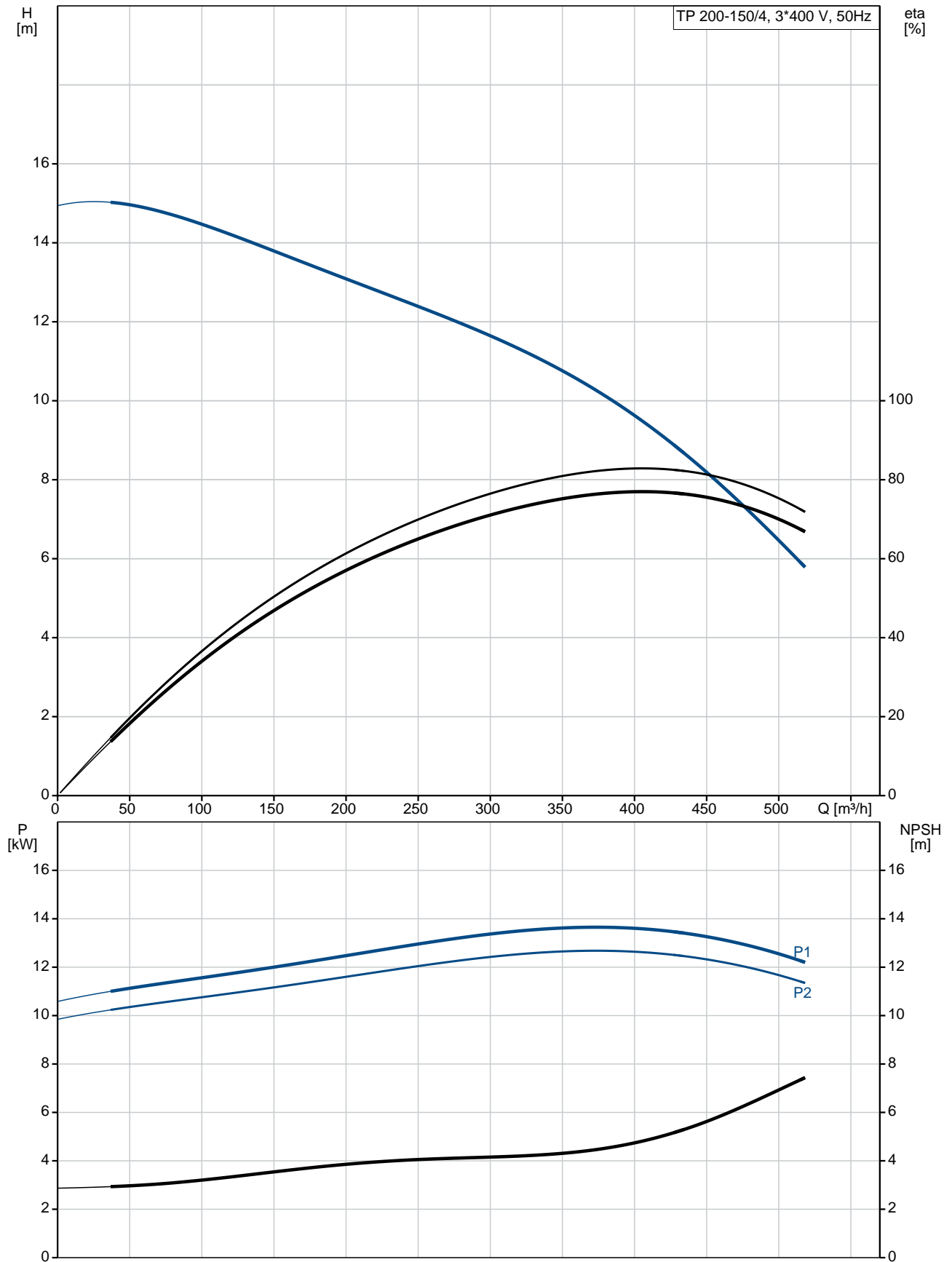

Description	Value
General information:	
Product name:	TP 200-150/4 A-F-A-BQQE
Product No:	97927150
EAN number:	5710626546732
Technical:	
Speed for pump data:	1470 rpm
Rated flow:	396 m ³ /h
Rated head:	9.6 m
Head max:	150 dm
Actual impeller diameter:	224 mm
Primary shaft seal:	BQQE
Curve tolerance:	ISO9906:2012 3B
Pump version:	A
Model:	A
Materials:	
Pump housing:	Cast iron EN-JL1040 ASTM A48-40 B
Impeller:	Cast iron EN-JL1030 ASTM A48-30 B
Material code:	A
Installation:	
Range of ambient temperature:	-30 .. 60 °C
Maximum operating pressure:	16 bar
Flange standard:	DIN
Connect code:	F
Pipe connection:	DN 200
Pump inlet:	DN 200
Pump outlet:	DN 200
Pressure stage:	PN 16
Port-to-port length:	900 mm
Flange size for motor:	FF300
Liquid:	
Pumped liquid:	Water
Liquid temperature range:	-25 .. 120 °C
Liquid temperature during operation:	20 °C
Density:	998.2 kg/m ³
Electrical data:	
Motor type:	160LB
IE Efficiency class:	IE3
Rated power - P2:	15 kW
Power (P2) required by pump:	15 kW
Mains frequency:	50 Hz
Rated voltage:	3 x 380-415D/660-690Y V
Rated current:	29,0-28,0/16,8-16,4 A
Starting current:	760-870 %
Cos phi - power factor:	0,86-0,82
Rated speed:	1460-1470 rpm
Efficiency:	IE3 92,1%
Motor efficiency at full load:	92.1 %
Motor efficiency at 3/4 load:	92.3 %
Motor efficiency at 1/2 load:	92.1 %
Number of poles:	4

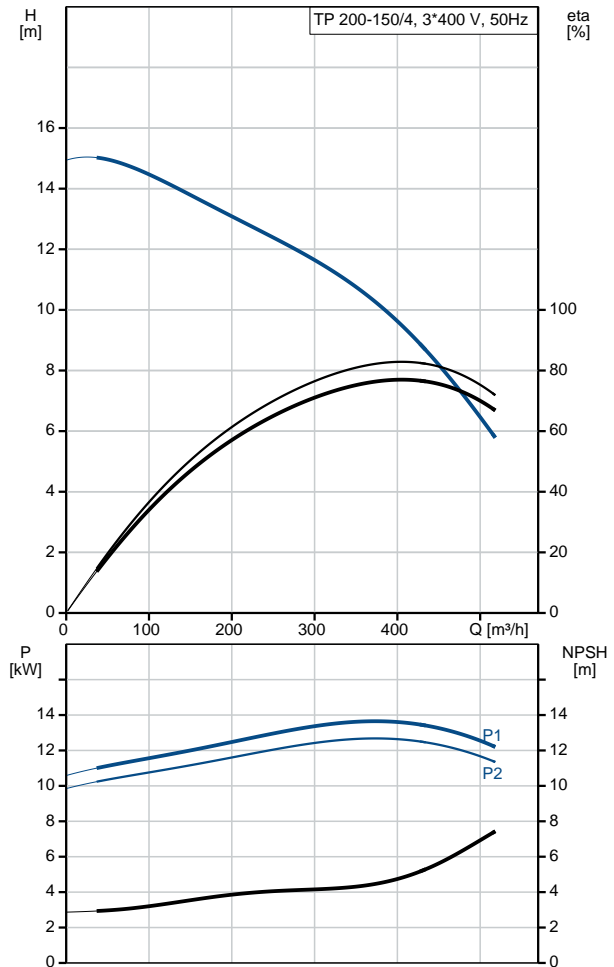



Company name:

Created by:

Phone:

Date:

06/09/2017

Description	Value
Enclosure class (IEC 34-5):	55 Dust/Jetting
Insulation class (IEC 85):	F
Motor protec:	PTC
Motor No:	87420032
Others:	
Label:	Grundfos Blueflux
Minimum efficiency index, MEI :	0.70
ErP status:	EuP Standalone/Prod.
Net weight:	383 kg
Gross weight:	479 kg
Shipping volume:	2.29 m ³
Danish:	VVS NO 381719150

97927150 TP 200-150/4 50 Hz

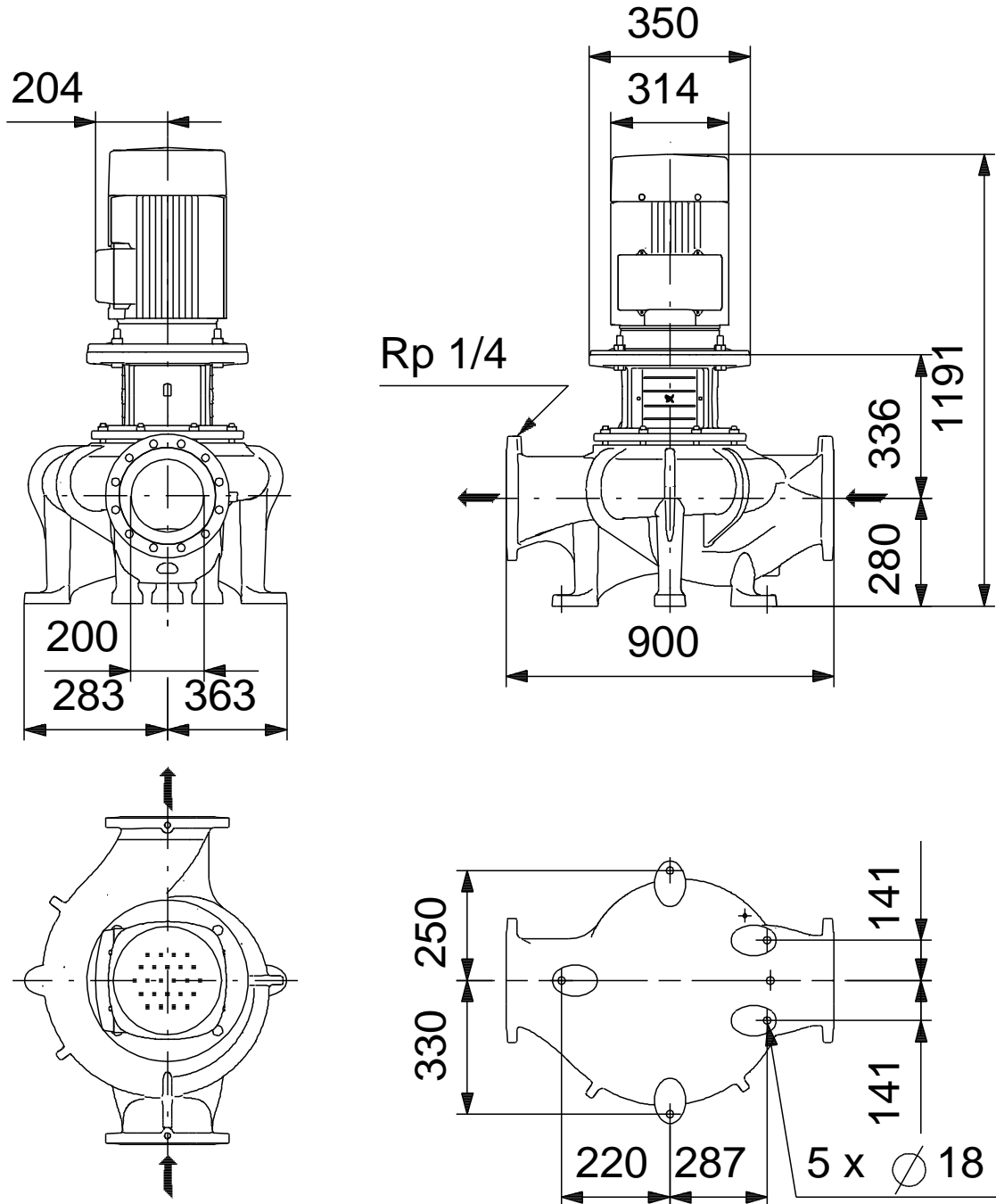

Note! All units are in [mm] unless others are stated.
Disclaimer: This simplified dimensional drawing does not show all details.

97927150 TP 200-150/4 50 Hz



IEC TP211 THERMALLY PROTECTED WHEN THE THERMISTORS ARE
CONNECTED TO AMPLIFIER RELAY FOR CONTROL OF MAIN SUPPLY
THERMISTORS PTC ACCORDING TO DIN 44082

Note! All units are in [mm] unless others are stated.