

Qty.	Description
1	<p data-bbox="199 336 518 369">CRN 5-8 A-FGJ-H-E-HQQE</p>  <p data-bbox="199 660 470 694">Product No.: 96531656</p> <p data-bbox="199 716 1404 817">Vertical, multistage centrifugal pump with inlet and outlet ports on same the level (inline). Pump materials in contact with the liquid are in high-grade stainless steel. A cartridge shaft seal ensures high reliability, safe handling, and easy access and service. Power transmission is via a rigid split coupling. Pipe connection is via combined DIN-ANSI-JIS flanges.</p> <p data-bbox="199 862 933 896">The pump is fitted with a 3-phase, fan-cooled asynchronous motor.</p> <p data-bbox="199 918 319 952">Controls:</p> <p data-bbox="199 952 638 985">Frequency converter: NONE</p> <p data-bbox="199 1008 295 1041">Liquid:</p> <p data-bbox="199 1041 638 1075">Pumped liquid: Water</p> <p data-bbox="199 1075 710 1108">Liquid temperature range: -20 .. 120 °C</p> <p data-bbox="199 1108 694 1142">Liquid temperature during operation: 20 °C</p> <p data-bbox="199 1142 702 1176">Density: 998.2 kg/m³</p> <p data-bbox="199 1198 327 1232">Technical:</p> <p data-bbox="199 1232 821 1265">Pump speed on which pump data are based: 2853 rpm</p> <p data-bbox="199 1265 662 1299">Rated flow: 5.8 m³/h</p> <p data-bbox="199 1299 646 1332">Rated head: 40.3 m</p> <p data-bbox="199 1332 654 1366">Pump orientation: Vertical</p> <p data-bbox="199 1366 638 1400">Shaft seal arrangement: Single</p> <p data-bbox="199 1400 638 1433">Code for shaft seal: HQQE</p> <p data-bbox="199 1433 726 1467">Approvals on nameplate: CE, EAC, ACS</p> <p data-bbox="199 1467 766 1500">Curve tolerance: ISO9906:2012 3B</p> <p data-bbox="199 1523 327 1556">Materials:</p> <p data-bbox="199 1556 726 1590">Base: Stainless steel</p> <p data-bbox="566 1590 686 1624">EN 1.4408</p> <p data-bbox="566 1624 662 1657">AISI 316</p> <p data-bbox="199 1657 726 1691">Impeller: Stainless steel</p> <p data-bbox="566 1691 686 1724">EN 1.4401</p> <p data-bbox="566 1724 662 1758">AISI 316</p> <p data-bbox="199 1758 614 1792">Bearing: SIC</p> <p data-bbox="199 1814 343 1848">Installation:</p> <p data-bbox="199 1848 630 1881">Maximum ambient temperature: 60 °C</p> <p data-bbox="199 1881 638 1915">Maximum operating pressure: 25 bar</p> <p data-bbox="199 1915 742 1948">Max pressure at stated temp: 25 bar / 120 °C</p> <p data-bbox="566 1948 734 1982">25 bar / -20 °C</p> <p data-bbox="199 1982 742 2016">Type of connection: DIN / ANSI / JIS</p> <p data-bbox="199 2016 678 2049">Size of inlet connection: DN 25/32</p> <p data-bbox="566 2049 678 2083">1 1/4 inch</p> <p data-bbox="199 2083 678 2116">Size of outlet connection: DN 25/32</p> <p data-bbox="566 2116 678 2150">1 1/4 inch</p> <p data-bbox="199 2150 686 2184">Pressure rating for pipe connection: PN 25</p> <p data-bbox="199 2184 638 2217">Flange rating inlet: 300 lb</p>

Qty.	Description
	<p>Flange size for motor: FT100</p> <p>Electrical data:</p> <p>Motor standard: IEC</p> <p>Motor type: 80C</p> <p>IE Efficiency class: IE3</p> <p>Rated power - P2: 1.1 kW</p> <p>Power (P2) required by pump: 1.1 kW</p> <p>Mains frequency: 50 Hz</p> <p>Rated voltage: 3 x 220-240D/380-415Y V</p> <p>Rated current: 4.35/2.50 A</p> <p>Starting current: 450-500 %</p> <p>Cos phi - power factor: 0.83-0.76</p> <p>Rated speed: 2840-2870 rpm</p> <p>Efficiency: IE3 82,7%</p> <p>Motor efficiency at full load: 82.7 %</p> <p>Motor efficiency at 3/4 load: 84.6 %</p> <p>Motor efficiency at 1/2 load: 85.4 %</p> <p>Number of poles: 2</p> <p>Enclosure class (IEC 34-5): 55 Dust/Jetting</p> <p>Insulation class (IEC 85): F</p> <p>Others:</p> <p>Minimum efficiency index, MEI $\hat{\alpha}\%$: 0.57</p> <p>Net weight: 27.3 kg</p> <p>Gross weight: 30.2 kg</p> <p>Shipping volume: 0.074 m³</p> <p>Country of origin: GB</p> <p>Custom tariff no.: 84137075</p>

96531656 CRN 5-8 A-FGJ-H-E-HQQE 50 Hz

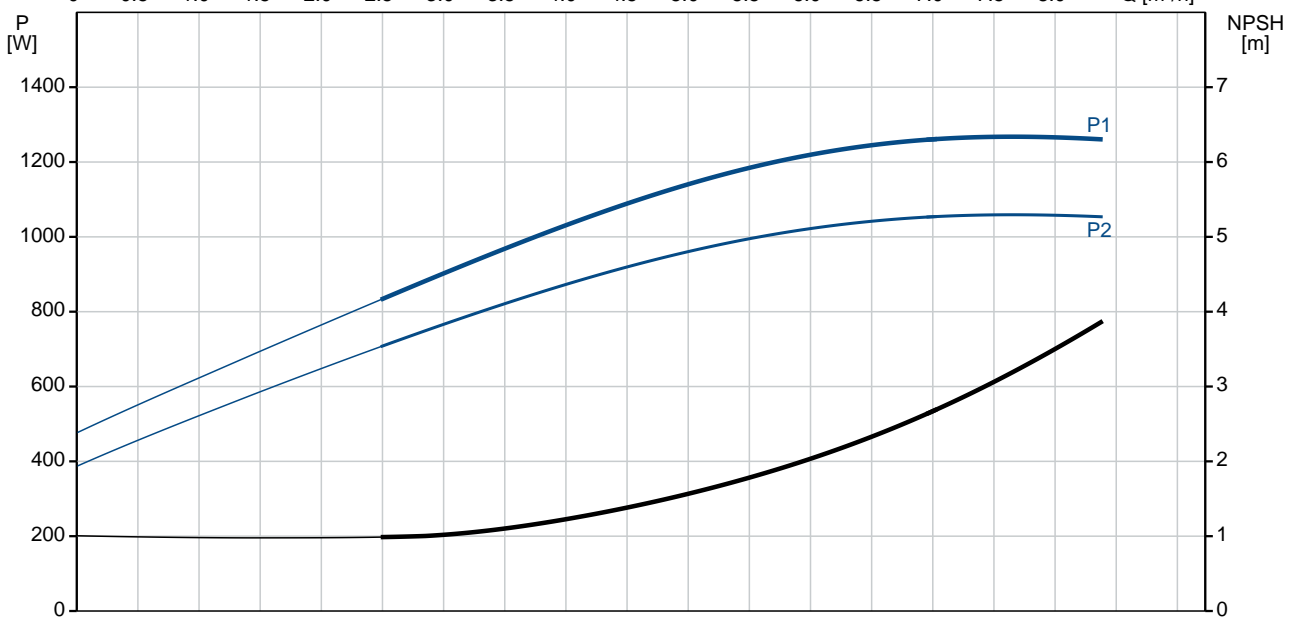
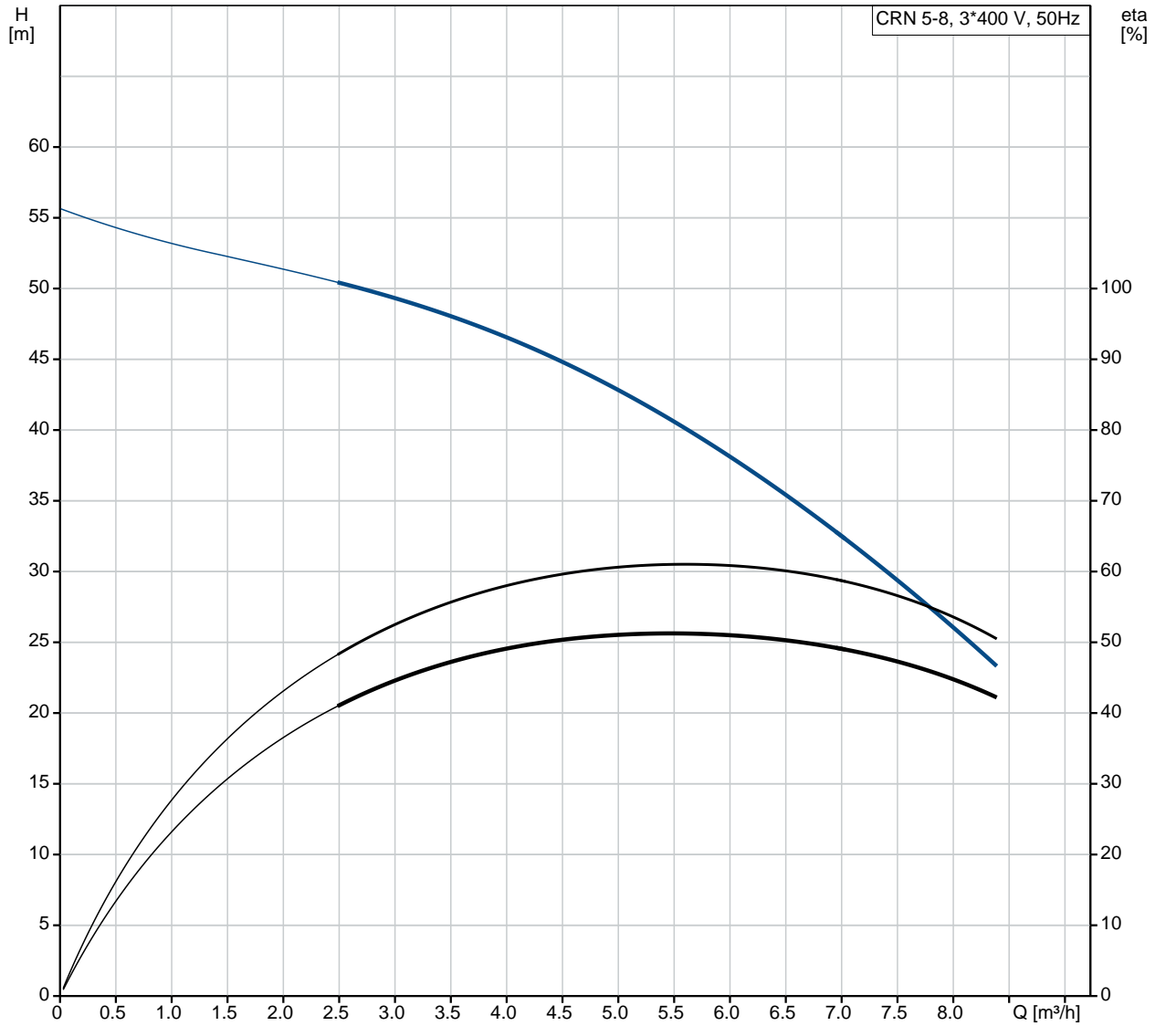

Description	Value
General information:	
Product name:	CRN 5-8
	A-FGJ-H-E-HQQE
Product No:	96531656
EAN number:	5700397305690
Price:	1.269,00 GBP
Technical:	
Pump speed on which pump data are based:	2853 rpm
Rated flow:	5.8 m ³ /h
Rated head:	40.3 m
Head max:	56.5 m
Stages:	8
Impellers:	8
Number of reduced-diameter impellers:	0
Low NPSH:	N
Pump orientation:	Vertical
Shaft seal arrangement:	Single
Code for shaft seal:	HQQE
Approvals on nameplate:	CE, EAC, ACS
Curve tolerance:	ISO9906:2012 3B
Pump version:	A
Model:	A
Materials:	
Base:	Stainless steel
	EN 1.4408
	AISI 316
Impeller:	Stainless steel
	EN 1.4401
	AISI 316
Material code:	H
Code for rubber:	E
Bearing:	SIC
Installation:	
Maximum ambient temperature:	60 °C
Maximum operating pressure:	25 bar
Max pressure at stated temp:	25 bar / 120 °C
	25 bar / -20 °C
Type of connection:	DIN / ANSI / JIS
Size of inlet connection:	DN 25/32
	1 1/4 inch
Size of outlet connection:	DN 25/32
	1 1/4 inch
Pressure rating for pipe connection:	PN 25
Flange rating inlet:	300 lb
Flange size for motor:	FT100
Connect code:	FGJ
Liquid:	
Pumped liquid:	Water
Liquid temperature range:	-20 .. 120 °C
Liquid temperature during operation:	20 °C
Density:	998.2 kg/m ³
Electrical data:	
Motor standard:	IEC
Motor type:	80C
IE Efficiency class:	IE3
Rated power - P2:	1.1 kW
Power (P2) required by pump:	1.1 kW
Mains frequency:	50 Hz

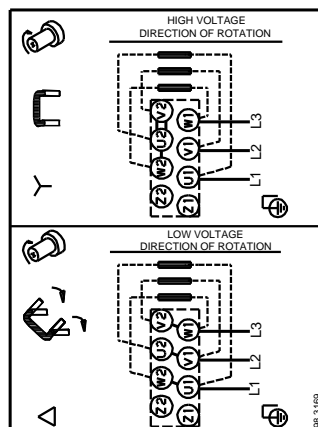
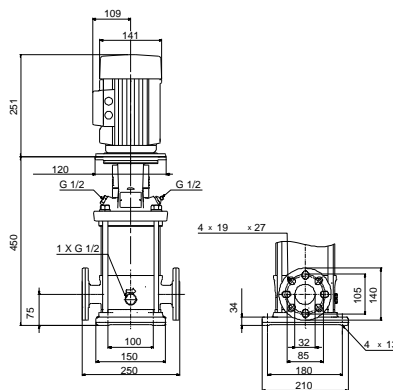
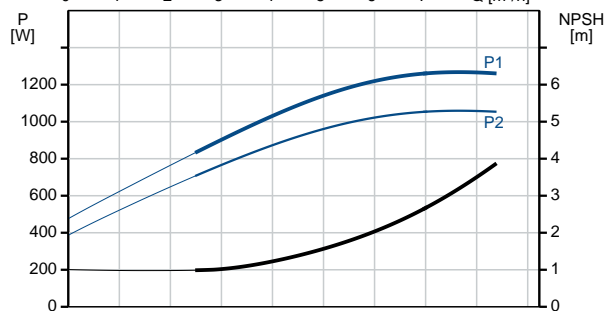
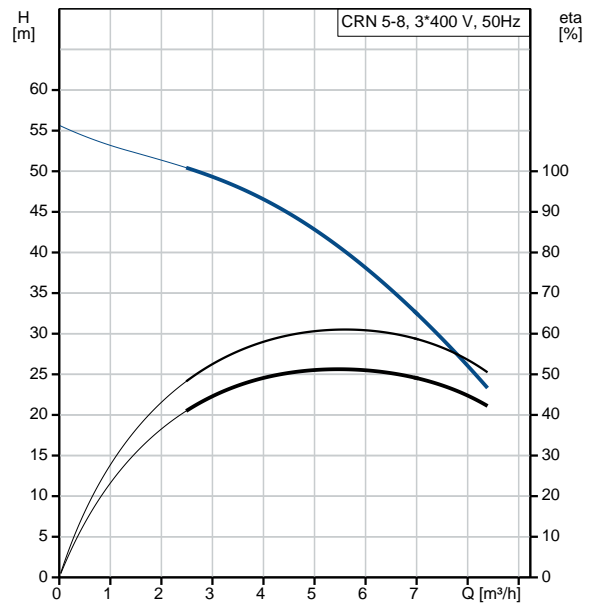



Company name:

Created by:

Phone:

Date:

07/03/2019

Description	Value
Rated voltage:	3 x 220-240D/380-415Y V
Rated current:	4.35/2.50 A
Starting current:	450-500 %
Cos phi - power factor:	0.83-0.76
Rated speed:	2840-2870 rpm
Efficiency:	IE3 82,7%
Motor efficiency at full load:	82.7 %
Motor efficiency at 3/4 load:	84.6 %
Motor efficiency at 1/2 load:	85.4 %
Number of poles:	2
Enclosure class (IEC 34-5):	55 Dust/Jetting
Insulation class (IEC 85):	F
Motor protec:	NONE
Motor No:	85U05105
Controls:	
Frequency converter:	NONE
Others:	
Minimum efficiency index, MEI %:	0.57
Net weight:	27.3 kg
Gross weight:	30.2 kg
Shipping volume:	0.074 m ³
Sales region:	Great Britain
Country of origin:	GB
Custom tariff no.:	84137075

96531656 CRN 5-8 A-FGJ-H-E-HQQE 50 Hz

