

Position	Qty.	Description
	1	<p>CRI 1-27 A-FGJ-I-V-HQQV</p>  <p>Product No.: 96530622</p> <p>Vertical, multistage centrifugal pump with suction and discharge ports on same the level (in-line) enabling installation in a horizontal one-pipe system. Pump materials in contact with the liquid are in stainless steel. A cartridge shaft seal ensures high reliability, safe handling and easy service and access. Power transmission is via a rigid split coupling. Pipework connection is via combined DIN-ANSI-JIS flanges.</p> <p>The pump is fitted with a 3-phase, fan-cooled asynchronous motor.</p> <p>Liquid: Pumped liquid: Water Liquid temperature range: -20 .. 90 °C Liquid temperature during operation: 20 °C Density: 998.2 kg/m³</p> <p>Technical: Rated flow: 1.8 m³/h Rated head: 128.3 m Pump orientation: Vertical Shaft seal arrangement: Single Code for shaft seal: HQQV Approvals on nameplate: CE, EAC Curve tolerance: ISO9906:2012 3B</p> <p>Materials: Base: Stainless steel EN 1.4408 AISI 316 Impeller: Stainless steel EN 1.4301 AISI 304 Bearing: SIC</p> <p>Installation: Maximum ambient temperature: 60 °C Maximum operating pressure: 25 bar Max pressure at stated temp: 25 bar / 90 °C 25 bar / -20 °C Type of connection: DIN / ANSI / JIS Size of inlet connection: DN 25/32 1 1/4 inch Size of outlet connection: DN 25/32 1 1/4 inch Pressure rating for pipe connection: PN 25 Flange rating inlet: 300 lb Flange size for motor: FT115</p>

Position	Qty.	Description
		<p>Electrical data:</p> <p>Motor standard: IEC</p> <p>Motor type: 90SB</p> <p>IE Efficiency class: IE3</p> <p>Rated power - P2: 1.5 kW</p> <p>Power (P2) required by pump: 1.5 kW</p> <p>Mains frequency: 50 Hz</p> <p>Rated voltage: 3 x 220-240D/380-415Y V</p> <p>Rated current: 5.45/3.15 A</p> <p>Starting current: 850-930 %</p> <p>Cos phi - power factor: 0.87-0.82</p> <p>Rated speed: 2890-2910 rpm</p> <p>Efficiency: IE3 84,2%</p> <p>Motor efficiency at full load: 84.2 %</p> <p>Motor efficiency at 3/4 load: 84.5 %</p> <p>Motor efficiency at 1/2 load: 83.1 %</p> <p>Number of poles: 2</p> <p>Enclosure class (IEC 34-5): 55 Dust/Jetting</p> <p>Insulation class (IEC 85): F</p> <p>Controls:</p> <p>Frequency converter: NONE</p> <p>Others:</p> <p>Minimum efficiency index, MEI : 0.7</p> <p>Net weight: 43.3 kg</p> <p>Gross weight: 46.2 kg</p> <p>Shipping volume: 0.13 m³</p> <p>Country of origin: GB</p> <p>Custom tariff no.: 84137075</p>

96530622 CRI 1-27 A-FGJ-I-V-HQQV 50 Hz

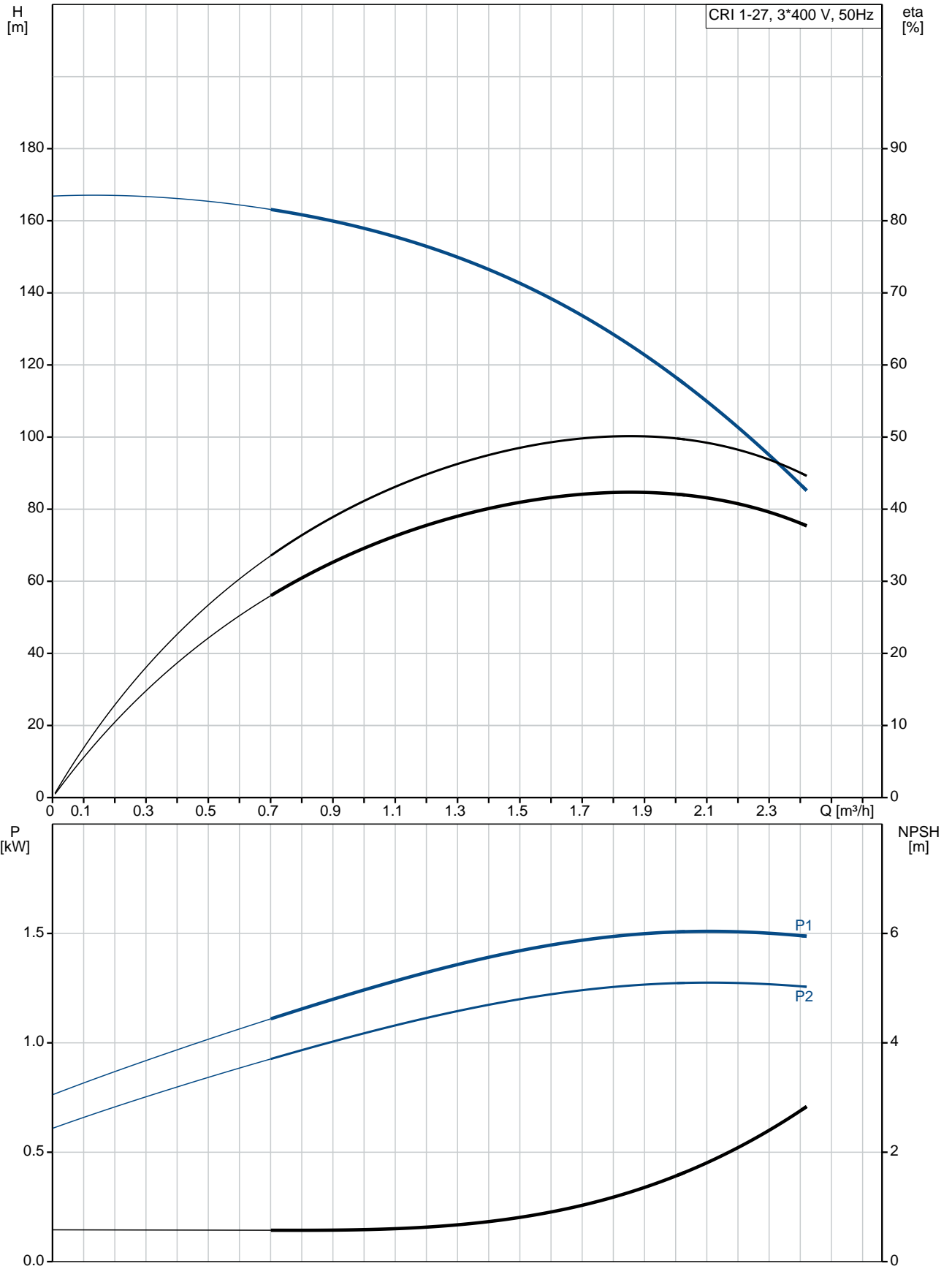

Description	Value
General information:	
Product name:	CRI 1-27 A-FGJ-I-V-HQQV
Product No:	96530622
EAN number:	5700397212813
Price:	1.589,00 GBP
Technical:	
Rated flow:	1.8 m ³ /h
Rated head:	128.3 m
Stages:	27
Impellers:	27
Low NPSH:	N
Pump orientation:	Vertical
Shaft seal arrangement:	Single
Code for shaft seal:	HQQV
Approvals on nameplate:	CE, EAC
Curve tolerance:	ISO9906:2012 3B
Pump version:	A
Model:	A
Materials:	
Base:	Stainless steel
	EN 1.4408
	AISI 316
Impeller:	Stainless steel
	EN 1.4301
	AISI 304
Material code:	I
Code for rubber:	V
Bearing:	SIC
Installation:	
Maximum ambient temperature:	60 °C
Maximum operating pressure:	25 bar
Max pressure at stated temp:	25 bar / 90 °C
	25 bar / -20 °C
Type of connection:	DIN / ANSI / JIS
Size of inlet connection:	DN 25/32
	1 1/4 inch
Size of outlet connection:	DN 25/32
	1 1/4 inch
Pressure rating for pipe connection:	PN 25
Flange rating inlet:	300 lb
Flange size for motor:	FT115
Connect code:	FGJ
Liquid:	
Pumped liquid:	Water
Liquid temperature range:	-20 .. 90 °C
Liquid temperature during operation:	20 °C
Density:	998.2 kg/m ³
Electrical data:	
Motor standard:	IEC
Motor type:	90SB
IE Efficiency class:	IE3
Rated power - P2:	1.5 kW
Power (P2) required by pump:	1.5 kW
Mains frequency:	50 Hz
Rated voltage:	3 x 220-240D/380-415Y V
Rated current:	5.45/3.15 A
Starting current:	850-930 %
Cos phi - power factor:	0.87-0.82

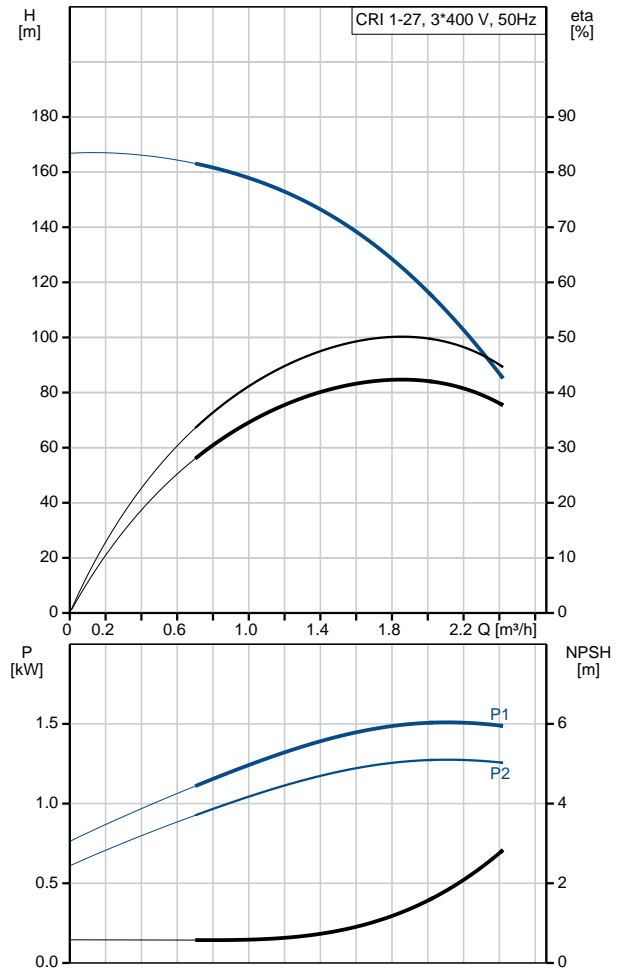



Company name:

Created by:

Phone:

Date:

12/09/2018

Description	Value
Rated speed:	2890-2910 rpm
Efficiency:	IE3 84,2%
Motor efficiency at full load:	84.2 %
Motor efficiency at 3/4 load:	84.5 %
Motor efficiency at 1/2 load:	83.1 %
Number of poles:	2
Enclosure class (IEC 34-5):	55 Dust/Jetting
Insulation class (IEC 85):	F
Motor protec:	NONE
Motor No:	85U05906
Controls:	
Frequency converter:	NONE
Others:	
Minimum efficiency index, MEI :	0.7
Net weight:	43.3 kg
Gross weight:	46.2 kg
Shipping volume:	0.13 m ³
Sales region:	GB
Country of origin:	GB
Custom tariff no.:	84137075

96530622 CRI 1-27 A-FGJ-I-V-HQQV 50 Hz

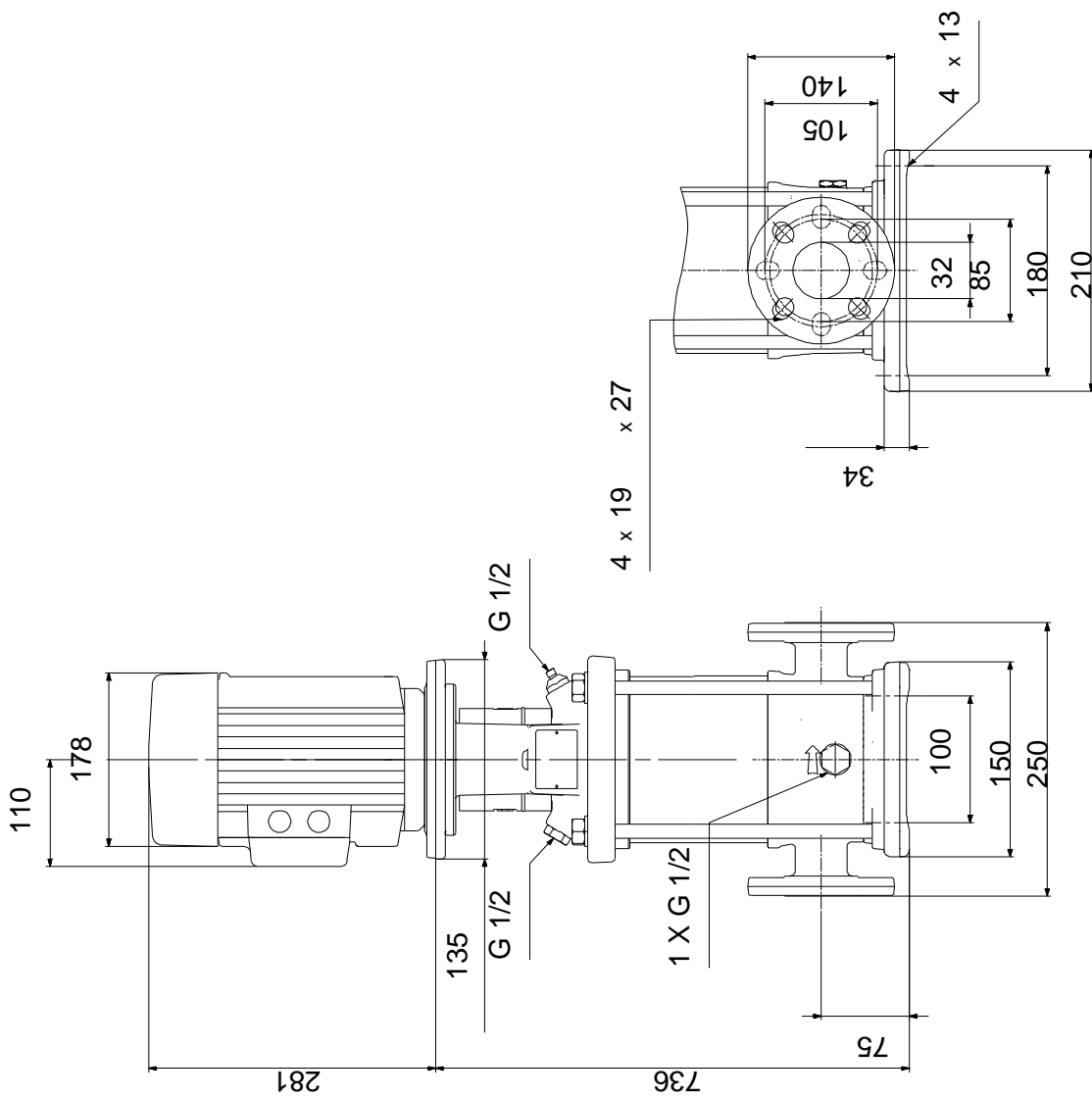

Note! All units are in [mm] unless others are stated.
Disclaimer: This simplified dimensional drawing does not show all details.

96530622 CRI 1-27 A-FGJ-I-V-HQQV 50 Hz



Note! All units are in [mm] unless others are stated.