

Position	Qty.	Description
	1	<p>CRI 5-36 A-FGJ-I-V-HQQV</p>  <p>Product No.: 96528044</p> <p>Vertical, multistage centrifugal pump with suction and discharge ports on same the level (in-line) enabling installation in a horizontal one-pipe system. Pump materials in contact with the liquid are in stainless steel. A cartridge shaft seal ensures high reliability, safe handling and easy service and access. Power transmission is via a rigid split coupling. Pipework connection is via combined DIN-ANSI-JIS flanges.</p> <p>The pump is fitted with a 3-phase, fan-cooled asynchronous motor.</p> <p>Liquid: Pumped liquid: Water Liquid temperature range: -20 .. 90 °C Liquid temperature during operation: 20 °C Density: 998.2 kg/m³</p> <p>Technical: Rated flow: 5.8 m³/h Rated head: 189.2 m Pump orientation: Vertical Shaft seal arrangement: Single Code for shaft seal: HQQV Approvals on nameplate: CE, EAC Curve tolerance: ISO9906:2012 3B</p> <p>Materials: Base: Stainless steel EN 1.4408 AISI 316 Impeller: Stainless steel EN 1.4301 AISI 304 Bearing: SIC</p> <p>Installation: Maximum ambient temperature: 60 °C Maximum operating pressure: 25 bar Max pressure at stated temp: 25 bar / 90 °C 25 bar / -20 °C Type of connection: DIN / ANSI / JIS Size of inlet connection: DN 25/32 1 1/4 inch Size of outlet connection: DN 25/32 1 1/4 inch Pressure rating for pipe connection: PN 25 Flange rating inlet: 300 lb Flange size for motor: FF265</p>

Position	Qty.	Description
		<p>Electrical data:</p> <p>Motor standard: IEC</p> <p>Motor type: 132SC</p> <p>IE Efficiency class: IE3</p> <p>Rated power - P2: 5.5 kW</p> <p>Power (P2) required by pump: 5.5 kW</p> <p>Mains frequency: 50 Hz</p> <p>Rated voltage: 3 x 380-415D V</p> <p>Rated current: 11 A</p> <p>Starting current: 1080-1180 %</p> <p>Cos phi - power factor: 0.87-0.82</p> <p>Rated speed: 2920-2940 rpm</p> <p>Efficiency: IE3 89,2%</p> <p>Motor efficiency at full load: 89.2 %</p> <p>Motor efficiency at 3/4 load: 90.0 %</p> <p>Motor efficiency at 1/2 load: 89.6 %</p> <p>Number of poles: 2</p> <p>Enclosure class (IEC 34-5): 55 Dust/Jetting</p> <p>Insulation class (IEC 85): F</p> <p>Controls:</p> <p>Frequency converter: NONE</p> <p>Others:</p> <p>Minimum efficiency index, MEI : 0.57</p> <p>Net weight: 82.5 kg</p> <p>Gross weight: 107 kg</p> <p>Shipping volume: 0.429 m³</p> <p>Country of origin: GB</p> <p>Custom tariff no.: 84137075</p>

96528044 CRI 5-36 A-FGJ-I-V-HQQV 50 Hz

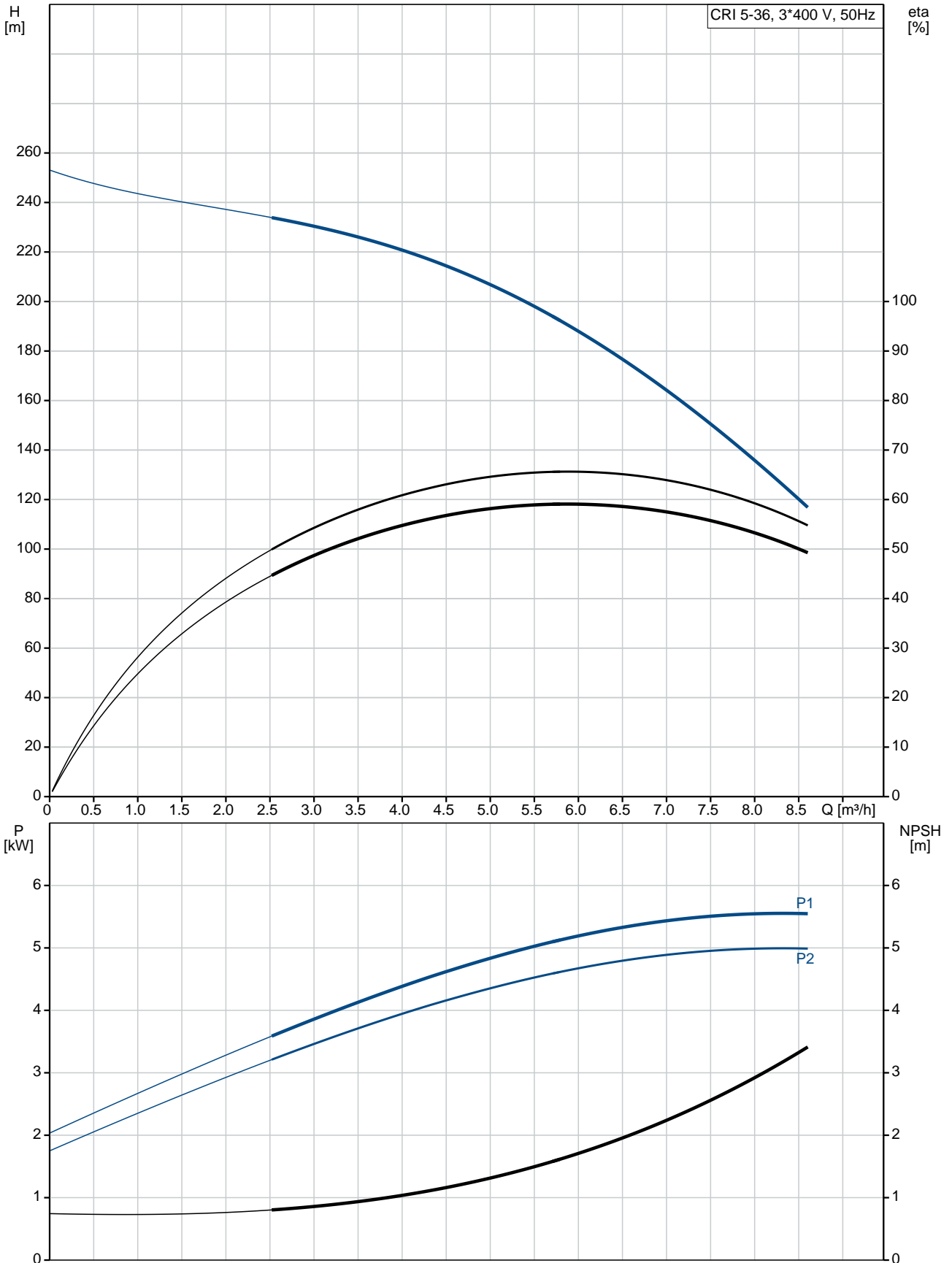

Description	Value
General information:	
Product name:	CRI 5-36 A-FGJ-I-V-HQQV
Product No:	96528044
EAN number:	5700397108994
Price:	2.439,00 GBP
Technical:	
Rated flow:	5.8 m ³ /h
Rated head:	189.2 m
Stages:	36
Impellers:	36
Low NPSH:	N
Pump orientation:	Vertical
Shaft seal arrangement:	Single
Code for shaft seal:	HQQV
Approvals on nameplate:	CE, EAC
Curve tolerance:	ISO9906:2012 3B
Pump version:	A
Model:	A
Materials:	
Base:	Stainless steel
	EN 1.4408
	AISI 316
Impeller:	Stainless steel
	EN 1.4301
	AISI 304
Material code:	I
Code for rubber:	V
Bearing:	SIC
Installation:	
Maximum ambient temperature:	60 °C
Maximum operating pressure:	25 bar
Max pressure at stated temp:	25 bar / 90 °C
	25 bar / -20 °C
Type of connection:	DIN / ANSI / JIS
Size of inlet connection:	DN 25/32
	1 1/4 inch
Size of outlet connection:	DN 25/32
	1 1/4 inch
Pressure rating for pipe connection:	PN 25
Flange rating inlet:	300 lb
Flange size for motor:	FF265
Connect code:	FGJ
Liquid:	
Pumped liquid:	Water
Liquid temperature range:	-20 .. 90 °C
Liquid temperature during operation:	20 °C
Density:	998.2 kg/m ³
Electrical data:	
Motor standard:	IEC
Motor type:	132SC
IE Efficiency class:	IE3
Rated power - P2:	5.5 kW
Power (P2) required by pump:	5.5 kW
Mains frequency:	50 Hz
Rated voltage:	3 x 380-415D V
Rated current:	11 A
Starting current:	1080-1180 %
Cos phi - power factor:	0.87-0.82

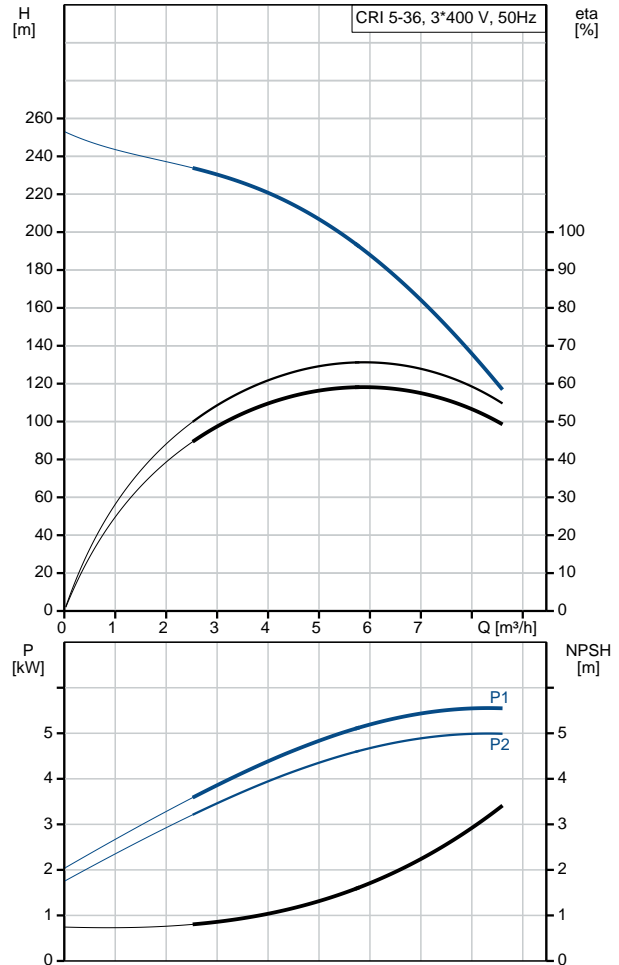



Company name:

Created by:

Phone:

Date:

13/09/2018

Description	Value
Rated speed:	2920-2940 rpm
Efficiency:	IE3 89,2%
Motor efficiency at full load:	89.2 %
Motor efficiency at 3/4 load:	90.0 %
Motor efficiency at 1/2 load:	89.6 %
Number of poles:	2
Enclosure class (IEC 34-5):	55 Dust/Jetting
Insulation class (IEC 85):	F
Motor protec:	PTC
Motor No:	85U17417
Controls:	
Frequency converter:	NONE
Others:	
Minimum efficiency index, MEI :	0.57
Net weight:	82.5 kg
Gross weight:	107 kg
Shipping volume:	0.429 m ³
Sales region:	GB
Country of origin:	GB
Custom tariff no.:	84137075

96528044 CRI 5-36 A-FGJ-I-V-HQQV 50 Hz

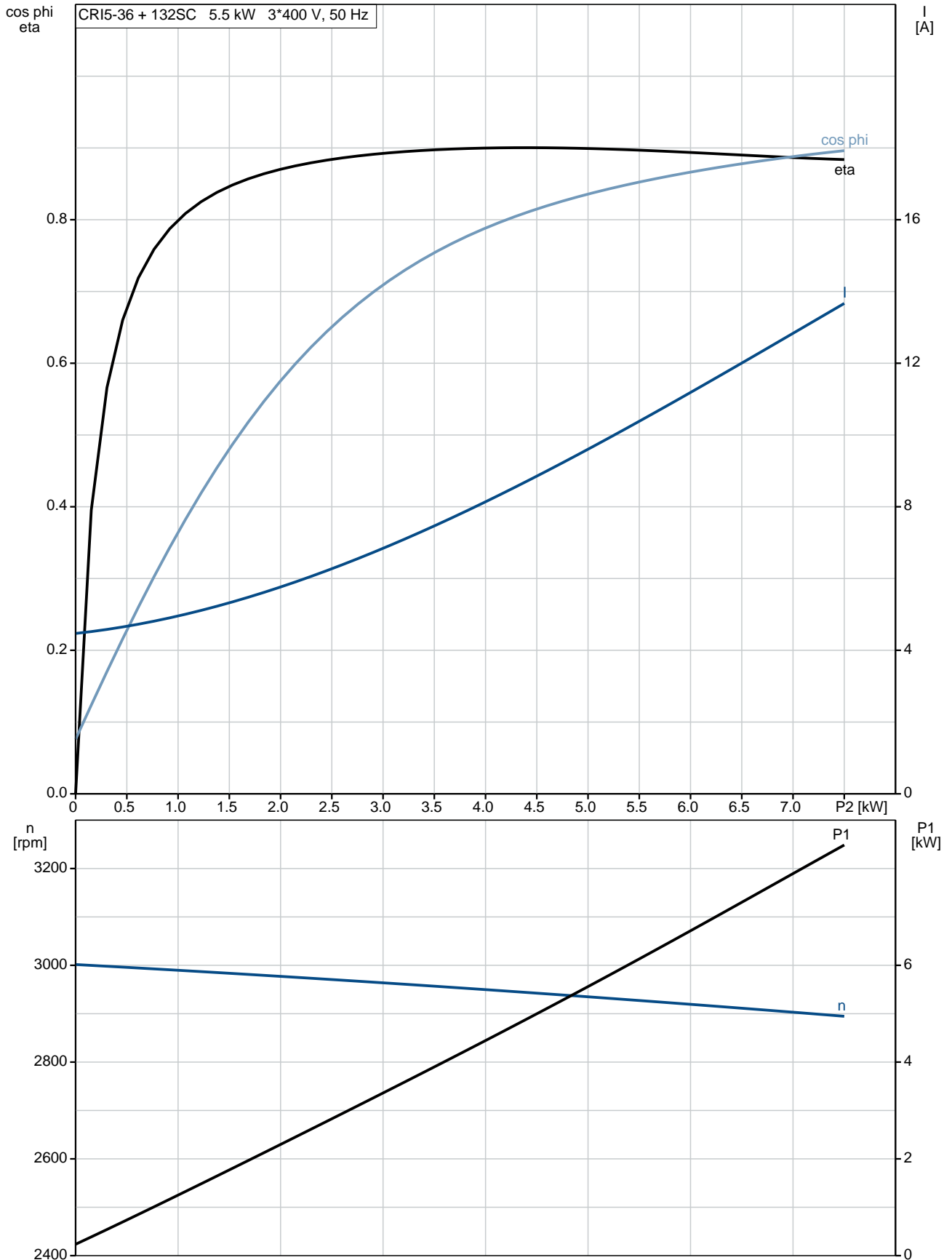

96528044 CRI 5-36 A-FGJ-I-V-HQQV 50 Hz

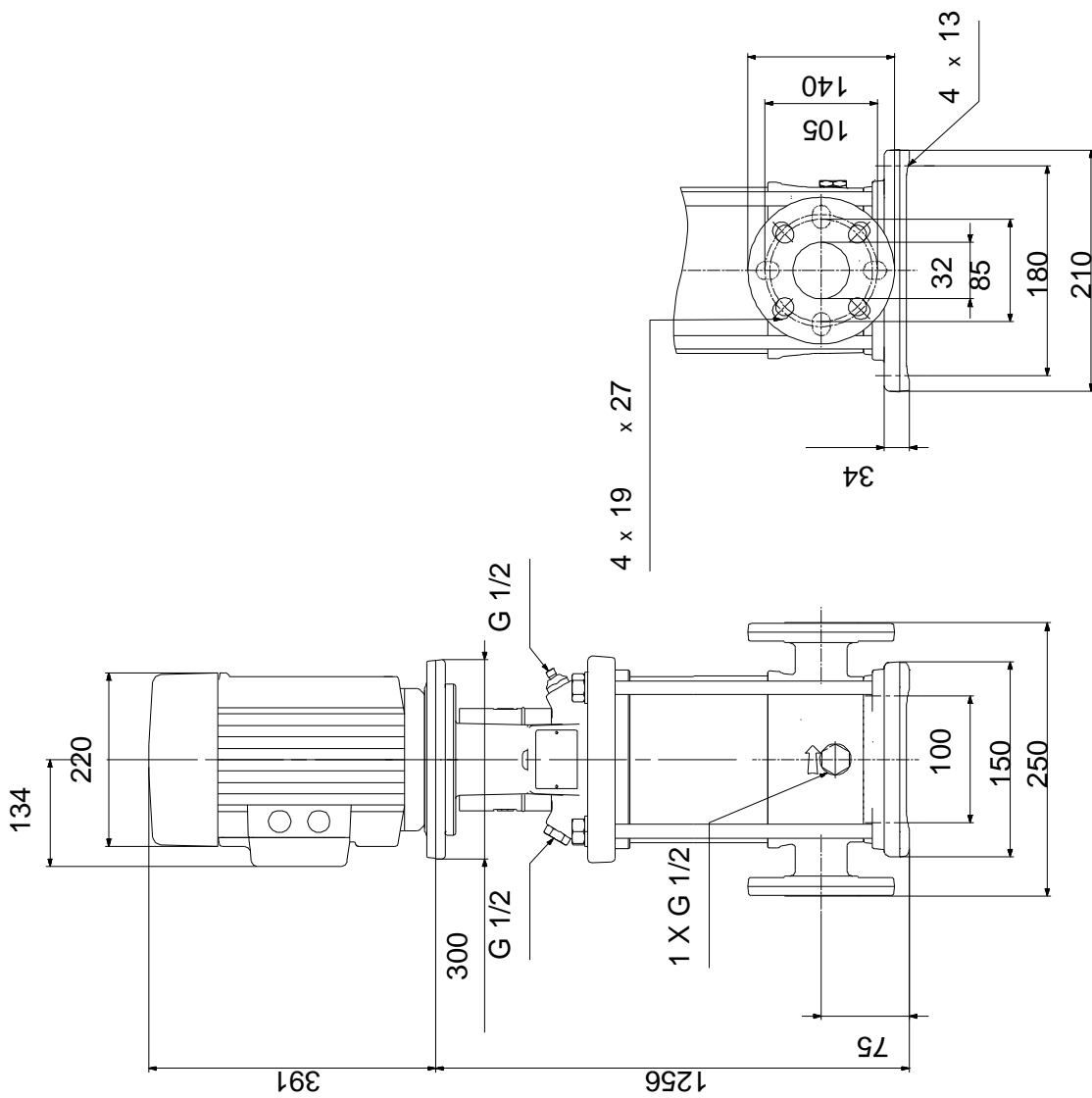

Note! All units are in [mm] unless others are stated.
Disclaimer: This simplified dimensional drawing does not show all details.

96528044 CRI 5-36 A-FGJ-I-V-HQQV 50 Hz

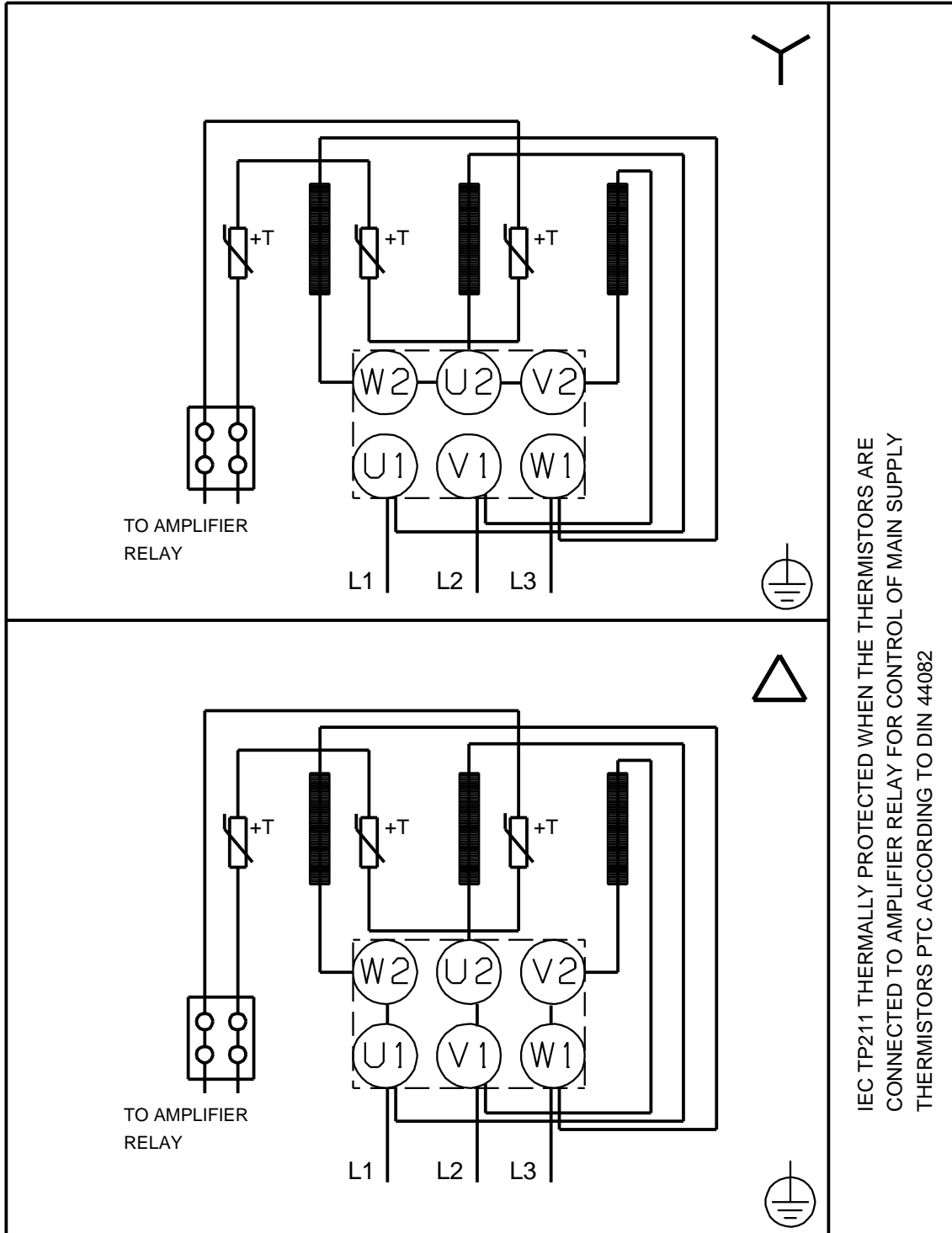

IEC TP211 THERMALLY PROTECTED WHEN THE THERMISTORS ARE
CONNECTED TO AMPLIFIER RELAY FOR CONTROL OF MAIN SUPPLY
THERMISTORS PTC ACCORDING TO DIN 44082

Note! All units are in [mm] unless others are stated.