

Position	Qty.	Description
	1	<p>CRI 3-31 A-FGJ-I-V-HQQV</p>  <p>Product No.: 96527945</p> <p>Vertical, multistage centrifugal pump with suction and discharge ports on same the level (in-line) enabling installation in a horizontal one-pipe system. Pump materials in contact with the liquid are in stainless steel. A cartridge shaft seal ensures high reliability, safe handling and easy service and access. Power transmission is via a rigid split coupling. Pipework connection is via combined DIN-ANSI-JIS flanges.</p> <p>The pump is fitted with a 3-phase, fan-cooled asynchronous motor.</p> <p>Liquid: Pumped liquid: Water Liquid temperature range: -20 .. 90 °C Liquid temperature during operation: 20 °C Density: 998.2 kg/m³</p> <p>Technical: Rated flow: 3 m³/h Rated head: 153.2 m Pump orientation: Vertical Shaft seal arrangement: Single Code for shaft seal: HQQV Approvals on nameplate: CE, EAC Curve tolerance: ISO9906:2012 3B</p> <p>Materials: Base: Stainless steel EN 1.4408 AISI 316 Impeller: Stainless steel EN 1.4301 AISI 304 Bearing: SIC</p> <p>Installation: Maximum ambient temperature: 60 °C Maximum operating pressure: 25 bar Max pressure at stated temp: 25 bar / 90 °C 25 bar / -20 °C Type of connection: DIN / ANSI / JIS Size of inlet connection: DN 25/32 1 1/4 inch Size of outlet connection: DN 25/32 1 1/4 inch Pressure rating for pipe connection: PN 25 Flange rating inlet: 300 lb Flange size for motor: FT130</p> <p>Electrical data: Motor standard: IEC Motor type: 100LC IE Efficiency class: IE3 Rated power - P2: 3 kW Power (P2) required by pump: 3 kW</p>

Position	Qty.	Description
		Mains frequency: 50 Hz Rated voltage: 3 x 220-240D/380-415Y V Rated current: 11.0/6.30 A Starting current: 840-920 % Cos phi - power factor: 0.87-0.82 Rated speed: 2900-2920 rpm Efficiency: IE3 87,1% Motor efficiency at full load: 87.1 % Motor efficiency at 3/4 load: 88.0 % Motor efficiency at 1/2 load: 87.7 % Number of poles: 2 Enclosure class (IEC 34-5): 55 Dust/Jetting Insulation class (IEC 85): F Controls: Frequency converter: NONE Others: Minimum efficiency index, MEI : 0.7 Net weight: 52.5 kg Gross weight: 57.8 kg Shipping volume: 0.133 m ³ Country of origin: GB Custom tariff no.: 84137075

96527945 CRI 3-31 A-FGJ-I-V-HQQV 50 Hz

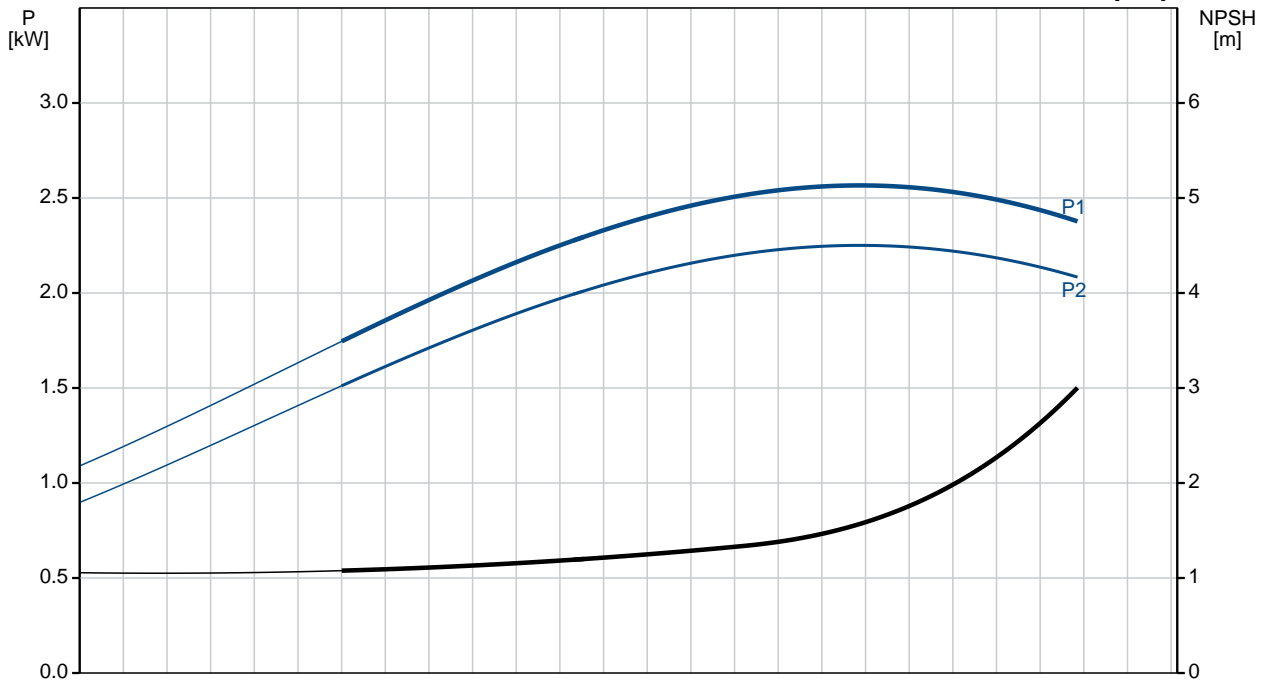
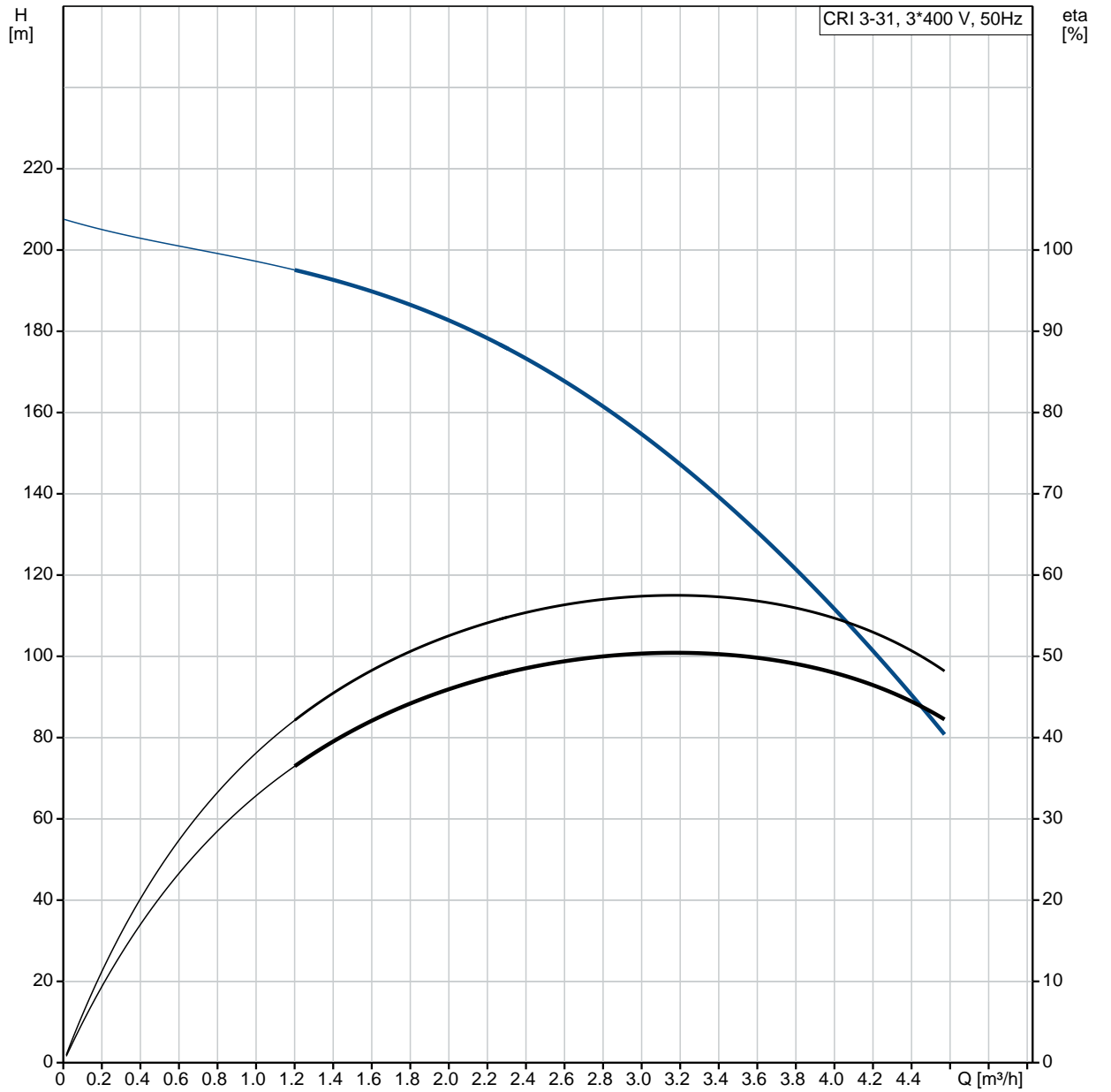

Description	Value
General information:	
Product name:	CRI 3-31 A-FGJ-I-V-HQQV
Product No:	96527945
EAN number:	5700397101216
Price:	1.811,00 GBP
Technical:	
Rated flow:	3 m ³ /h
Rated head:	153.2 m
Stages:	31
Impellers:	31
Low NPSH:	N
Pump orientation:	Vertical
Shaft seal arrangement:	Single
Code for shaft seal:	HQQV
Approvals on nameplate:	CE, EAC
Curve tolerance:	ISO9906:2012 3B
Pump version:	A
Model:	A
Materials:	
Base:	Stainless steel EN 1.4408 AISI 316
Impeller:	Stainless steel EN 1.4301 AISI 304
Material code:	I
Code for rubber:	V
Bearing:	SIC
Installation:	
Maximum ambient temperature:	60 °C
Maximum operating pressure:	25 bar
Max pressure at stated temp:	25 bar / 90 °C 25 bar / -20 °C
Type of connection:	DIN / ANSI / JIS
Size of inlet connection:	DN 25/32 1 1/4 inch
Size of outlet connection:	DN 25/32 1 1/4 inch
Pressure rating for pipe connection:	PN 25
Flange rating inlet:	300 lb
Flange size for motor:	FT130
Connect code:	FGJ
Liquid:	
Pumped liquid:	Water
Liquid temperature range:	-20 .. 90 °C
Liquid temperature during operation:	20 °C
Density:	998.2 kg/m ³
Electrical data:	
Motor standard:	IEC
Motor type:	100LC
IE Efficiency class:	IE3
Rated power - P2:	3 kW
Power (P2) required by pump:	3 kW
Mains frequency:	50 Hz
Rated voltage:	3 x 220-240D/380-415Y V
Rated current:	11.0/6.30 A
Starting current:	840-920 %
Cos phi - power factor:	0.87-0.82
Rated speed:	2900-2920 rpm
Efficiency:	IE3 87,1%
Motor efficiency at full load:	87.1 %
Motor efficiency at 3/4 load:	88.0 %
Motor efficiency at 1/2 load:	87.7 %

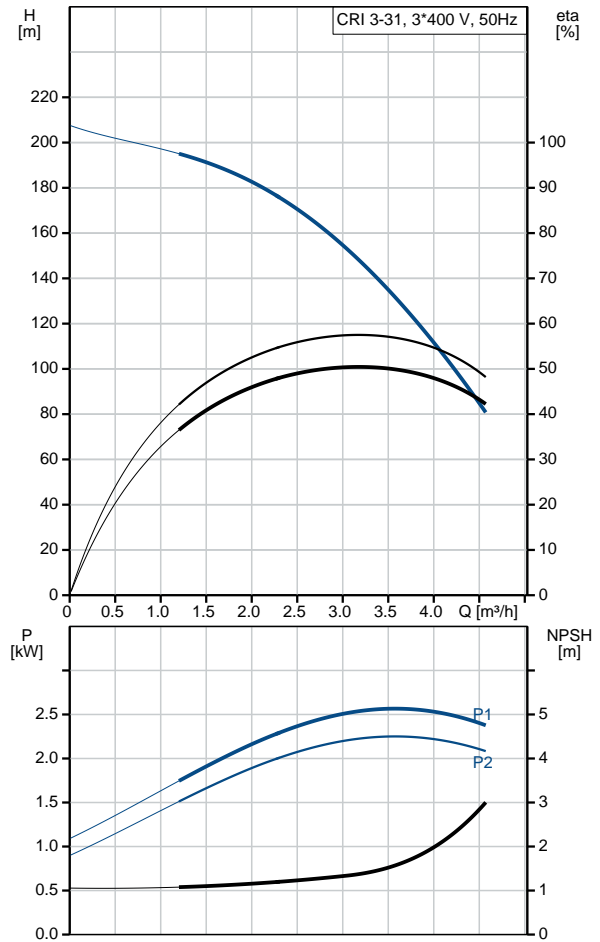

Description	Value
Number of poles:	2
Enclosure class (IEC 34-5):	55 Dust/Jetting
Insulation class (IEC 85):	F
Motor protec:	PTC
Motor No:	85U05510
Controls:	
Frequency converter:	NONE
Others:	
Minimum efficiency index, MEI :	0.7
Net weight:	52.5 kg
Gross weight:	57.8 kg
Shipping volume:	0.133 m ³
Sales region:	GB
Country of origin:	GB
Custom tariff no.:	84137075

96527945 CRI 3-31 A-FGJ-I-V-HQQV 50 Hz

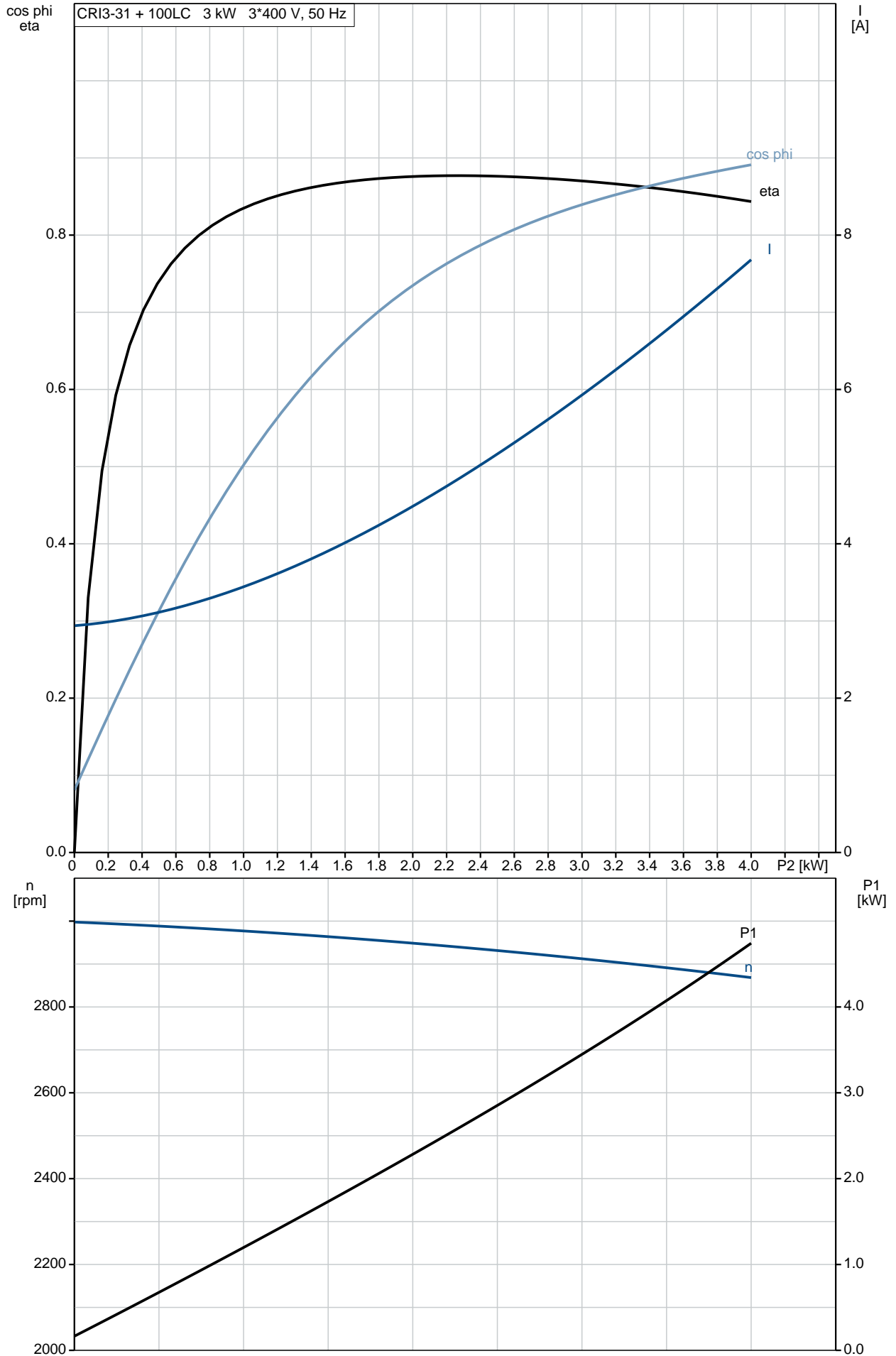

96527945 CRI 3-31 A-FGJ-I-V-HQQV 50 Hz

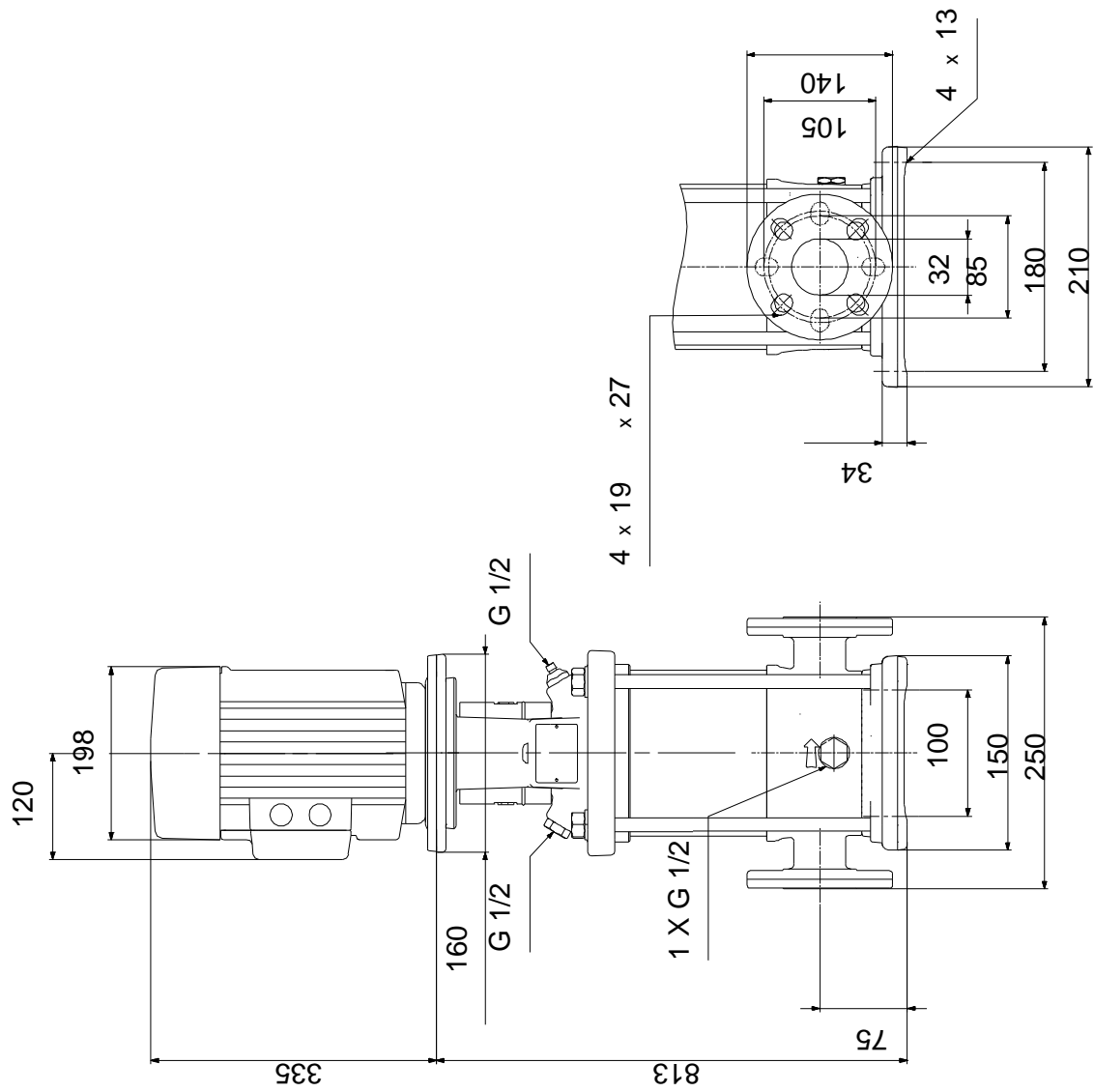

Note! All units are in [mm] unless others are stated.
Disclaimer: This simplified dimensional drawing does not show all details.

96527945 CRI 3-31 A-FGJ-I-V-HQQV 50 Hz

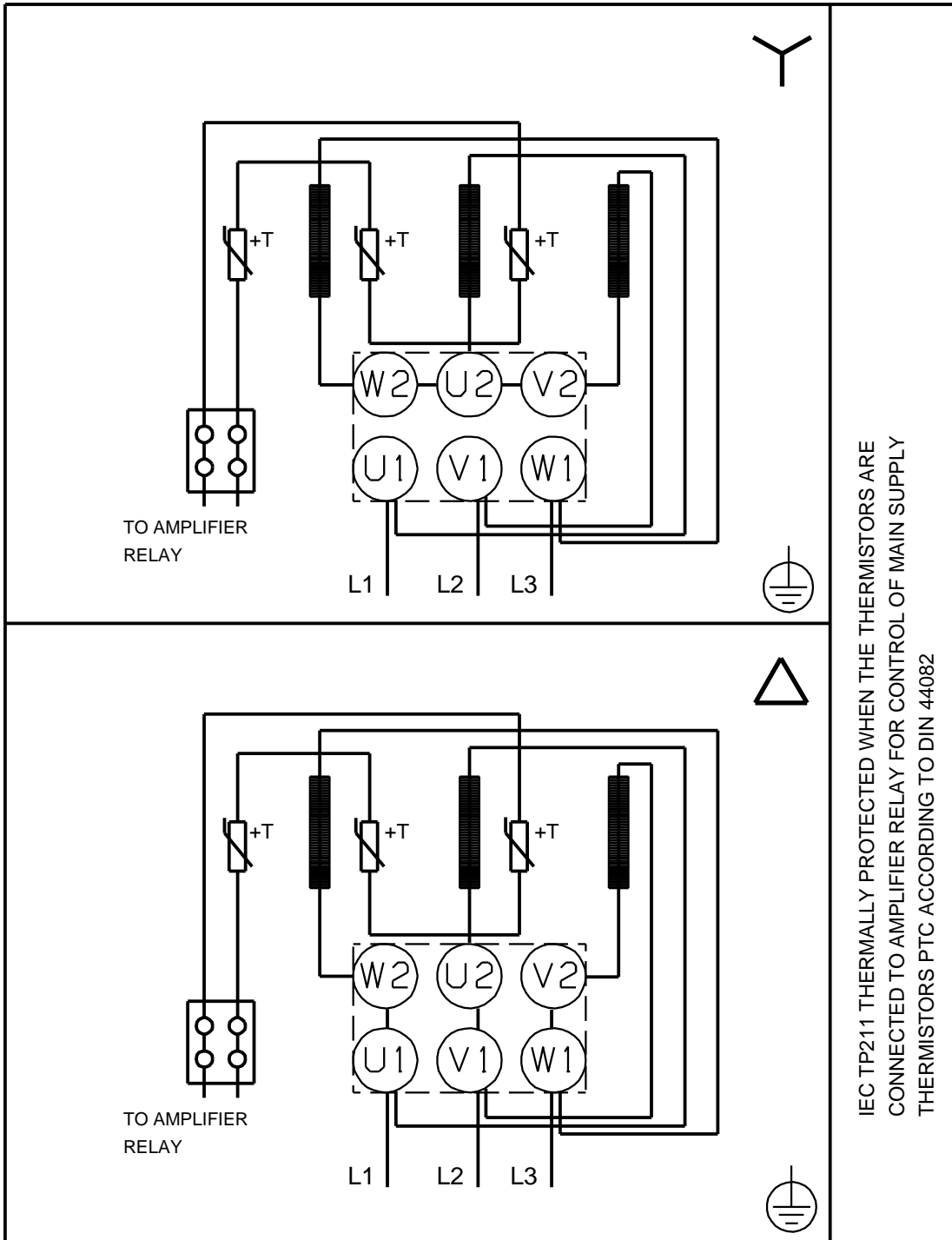

IEC TP211 THERMALLY PROTECTED WHEN THE THERMISTORS ARE CONNECTED TO AMPLIFIER RELAY FOR CONTROL OF MAIN SUPPLY THERMISTORS PTC ACCORDING TO DIN 44082

Note! All units are in [mm] unless others are stated.