

Qty.	Description
1	<p data-bbox="199 336 526 369">CRN 20-3 A-FGJ-H-E-HQQE</p>  <p data-bbox="199 660 470 689">Product No.: 96527807</p> <p data-bbox="199 716 1404 824">Vertical, multistage centrifugal pump with inlet and outlet ports on same the level (inline). Pump materials in contact with the liquid are in high-grade stainless steel. A cartridge shaft seal ensures high reliability, safe handling, and easy access and service. Power transmission is via a rigid split coupling. Pipe connection is via combined DIN-ANSI-JIS flanges.</p> <p data-bbox="199 862 933 891">The pump is fitted with a 3-phase, fan-cooled asynchronous motor.</p> <p data-bbox="199 922 311 952">Controls:</p> <p data-bbox="199 952 638 981">Frequency converter: NONE</p> <p data-bbox="199 1012 287 1041">Liquid:</p> <p data-bbox="199 1041 638 1070">Pumped liquid: Water</p> <p data-bbox="199 1070 710 1099">Liquid temperature range: -20 .. 120 °C</p> <p data-bbox="199 1099 686 1128">Liquid temperature during operation: 20 °C</p> <p data-bbox="199 1128 702 1158">Density: 998.2 kg/m³</p> <p data-bbox="199 1189 327 1218">Technical:</p> <p data-bbox="199 1218 821 1247">Pump speed on which pump data are based: 2917 rpm</p> <p data-bbox="199 1247 654 1276">Rated flow: 21 m³/h</p> <p data-bbox="199 1276 646 1305">Rated head: 34.6 m</p> <p data-bbox="199 1305 646 1335">Pump orientation: Vertical</p> <p data-bbox="199 1335 638 1364">Shaft seal arrangement: Single</p> <p data-bbox="199 1364 638 1393">Code for shaft seal: HQQE</p> <p data-bbox="199 1393 726 1422">Approvals on nameplate: CE, EAC, ACS</p> <p data-bbox="199 1422 766 1451">Curve tolerance: ISO9906:2012 3B</p> <p data-bbox="199 1482 319 1512">Materials:</p> <p data-bbox="199 1512 726 1601">Base: Stainless steel EN 1.4408 AISI 316</p> <p data-bbox="199 1601 726 1691">Impeller: Stainless steel EN 1.4401 AISI 316</p> <p data-bbox="199 1691 606 1720">Bearing: SIC</p> <p data-bbox="199 1751 343 1780">Installation:</p> <p data-bbox="199 1780 630 1809">Maximum ambient temperature: 60 °C</p> <p data-bbox="199 1809 638 1839">Maximum operating pressure: 25 bar</p> <p data-bbox="199 1839 742 1904">Max pressure at stated temp: 25 bar / 120 °C 25 bar / -20 °C</p> <p data-bbox="199 1904 742 1933">Type of connection: DIN / ANSI / JIS</p> <p data-bbox="199 1933 638 1962">Size of inlet connection: DN 50 2 inch</p> <p data-bbox="199 1962 638 2049">Size of outlet connection: DN 50 2 inch</p> <p data-bbox="199 2049 686 2078">Pressure rating for pipe connection: PN 25</p> <p data-bbox="199 2078 638 2107">Flange rating inlet: 300 lb</p>

Qty.	Description
	<p>Flange size for motor: FT130</p> <p>Electrical data:</p> <p>Motor standard: IEC</p> <p>Motor type: 112MC</p> <p>IE Efficiency class: IE3</p> <p>Rated power - P2: 4 kW</p> <p>Power (P2) required by pump: 4 kW</p> <p>Mains frequency: 50 Hz</p> <p>Rated voltage: 3 x 380-415D V</p> <p>Rated current: 7.9 A</p> <p>Starting current: 1000-1110 %</p> <p>Cos phi - power factor: 0.87-0.87</p> <p>Rated speed: 2920-2940 rpm</p> <p>Efficiency: IE3 88,1%</p> <p>Motor efficiency at full load: 88.1 %</p> <p>Motor efficiency at 3/4 load: 88.6 %</p> <p>Motor efficiency at 1/2 load: 85.2 %</p> <p>Number of poles: 2</p> <p>Enclosure class (IEC 34-5): 55 Dust/Jetting</p> <p>Insulation class (IEC 85): F</p> <p>Others:</p> <p>Minimum efficiency index, MEI $\hat{\alpha}\%$: 0.70</p> <p>Net weight: 67 kg</p> <p>Gross weight: 89 kg</p> <p>Shipping volume: 0.234 m³</p> <p>Country of origin: GB</p> <p>Custom tariff no.: 84137075</p>

96527807 CRN 20-3 A-FGJ-H-E-HQQE 50 Hz

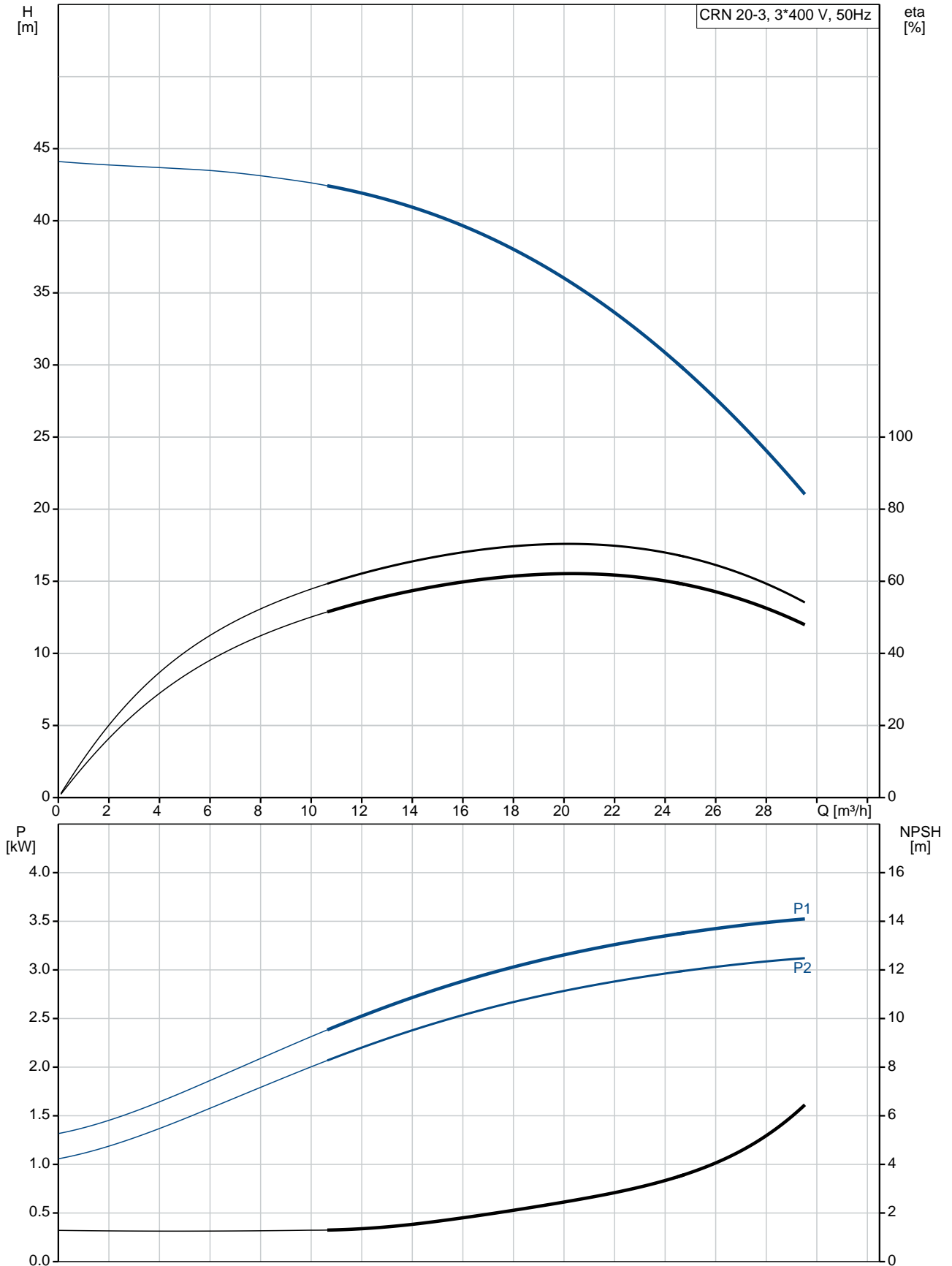

Description	Value
General information:	
Product name:	CRN 20-3 A-FGJ-H-E-HQQE
Product No:	96527807
EAN number:	5700397086797
Price:	2.685,00 GBP
Technical:	
Pump speed on which pump data are based:	2917 rpm
Rated flow:	21 m ³ /h
Rated head:	34.6 m
Head max:	43.9 m
Stages:	3
Impellers:	3
Number of reduced-diameter impellers:	0
Low NPSH:	N
Pump orientation:	Vertical
Shaft seal arrangement:	Single
Code for shaft seal:	HQQE
Approvals on nameplate:	CE, EAC, ACS
Curve tolerance:	ISO9906:2012 3B
Pump version:	A
Model:	A
Materials:	
Base:	Stainless steel EN 1.4408 AISI 316
Impeller:	Stainless steel EN 1.4401 AISI 316
Material code:	H
Code for rubber:	E
Bearing:	SIC
Installation:	
Maximum ambient temperature:	60 °C
Maximum operating pressure:	25 bar
Max pressure at stated temp:	25 bar / 120 °C 25 bar / -20 °C
Type of connection:	DIN / ANSI / JIS
Size of inlet connection:	DN 50 2 inch
Size of outlet connection:	DN 50 2 inch
Pressure rating for pipe connection:	PN 25
Flange rating inlet:	300 lb
Flange size for motor:	FT130
Connect code:	FGJ
Liquid:	
Pumped liquid:	Water
Liquid temperature range:	-20 .. 120 °C
Liquid temperature during operation:	20 °C
Density:	998.2 kg/m ³
Electrical data:	
Motor standard:	IEC
Motor type:	112MC
IE Efficiency class:	IE3
Rated power - P2:	4 kW
Power (P2) required by pump:	4 kW
Mains frequency:	50 Hz

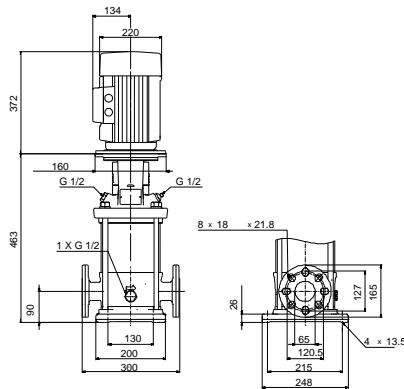
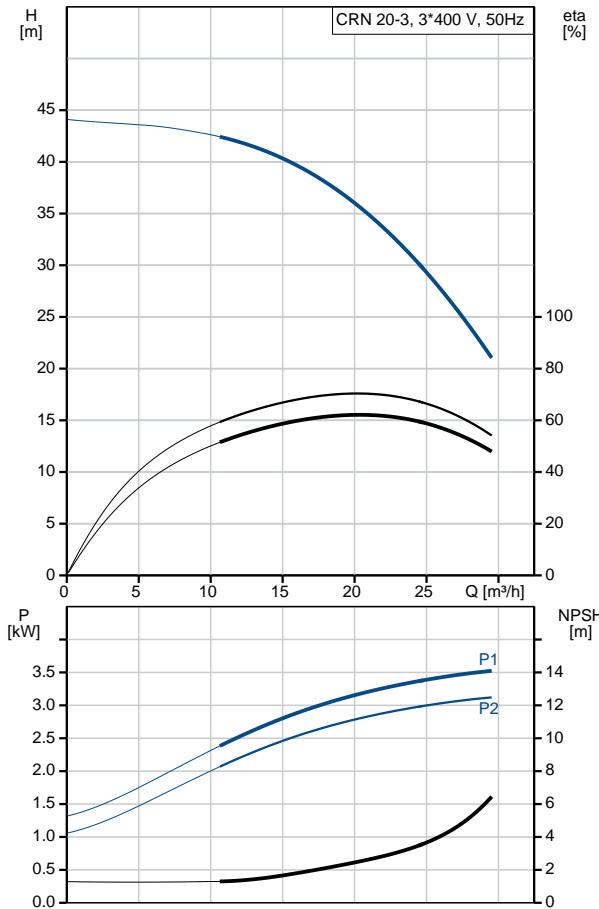



Company name:

Created by:

Phone:

Date:

12/03/2019

Description	Value
Rated voltage:	3 x 380-415D V
Rated current:	7.9 A
Starting current:	1000-1110 %
Cos phi - power factor:	0.87-0.87
Rated speed:	2920-2940 rpm
Efficiency:	IE3 88,1%
Motor efficiency at full load:	88.1 %
Motor efficiency at 3/4 load:	88.6 %
Motor efficiency at 1/2 load:	85.2 %
Number of poles:	2
Enclosure class (IEC 34-5):	55 Dust/Jetting
Insulation class (IEC 85):	F
Motor protec:	PTC
Motor No:	85U15413
Controls:	
Frequency converter:	NONE
Others:	
Minimum efficiency index, MEI %:	0.70
Net weight:	67 kg
Gross weight:	89 kg
Shipping volume:	0.234 m ³
Sales region:	Great Britain
Country of origin:	GB
Custom tariff no.:	84137075

96527807 CRN 20-3 A-FGJ-H-E-HQQE 50 Hz

