

Qty.	Description
1	<p data-bbox="199 338 483 369">CRN 5-8 A-P-A-E-HQQE</p>  <p data-bbox="199 660 469 687">Product No.: 96517245</p> <p data-bbox="199 719 1453 822">Vertical, multistage centrifugal pump with inlet and outlet ports on same the level (inline). Pump materials in contact with the liquid are in high-grade stainless steel. A cartridge shaft seal ensures high reliability, safe handling, and easy access and service. Power transmission is via a rigid split coupling. Pipe connection is via PJE (Victaulic®) couplings.</p> <p data-bbox="199 862 936 889">The pump is fitted with a 3-phase, fan-cooled asynchronous motor.</p> <p data-bbox="199 920 316 947">Controls:</p> <p data-bbox="199 952 638 978">Frequency converter: NONE</p> <p data-bbox="199 1010 288 1037">Liquid:</p> <p data-bbox="199 1041 707 1158">Pumped liquid: Water Liquid temperature range: -20 .. 120 °C Liquid temperature during operation: 20 °C Density: 998.2 kg/m³</p> <p data-bbox="199 1189 327 1216">Technical:</p> <p data-bbox="199 1220 821 1456">Pump speed on which pump data are based: 2853 rpm Rated flow: 5.8 m³/h Rated head: 40.3 m Pump orientation: Vertical Shaft seal arrangement: Single Code for shaft seal: HQQE Approvals on nameplate: CE, EAC, ACS Curve tolerance: ISO9906:2012 3B</p> <p data-bbox="199 1487 320 1514">Materials:</p> <p data-bbox="199 1518 729 1722">Base: Stainless steel EN 1.4408 AISI 316 Impeller: Stainless steel EN 1.4401 AISI 316 Bearing: SIC</p> <p data-bbox="199 1753 344 1780">Installation:</p> <p data-bbox="199 1785 743 2107">Maximum ambient temperature: 60 °C Maximum operating pressure: 25 bar Max pressure at stated temp: 25 bar / 120 °C 25 bar / -20 °C Type of connection: PJE Size of inlet connection: DN 32 1 1/4 inch Size of outlet connection: DN 32 1 1/4 inch Pressure rating for pipe connection: PN 50 Flange size for motor: FT100</p>

Qty.	Description
------	-------------

Electrical data:

Motor standard:	IEC
Motor type:	80C
IE Efficiency class:	IE3
Rated power - P2:	1.1 kW
Power (P2) required by pump:	1.1 kW
Mains frequency:	50 Hz
Rated voltage:	3 x 220-240D/380-415Y V
Rated current:	4.35/2.50 A
Starting current:	450-500 %
Cos phi - power factor:	0.83-0.76
Rated speed:	2840-2870 rpm
Efficiency:	IE3 82,7%
Motor efficiency at full load:	82.7 %
Motor efficiency at 3/4 load:	84.6 %
Motor efficiency at 1/2 load:	85.4 %
Number of poles:	2
Enclosure class (IEC 34-5):	55 Dust/Jetting
Insulation class (IEC 85):	F

Others:

Minimum efficiency index, MEI η_{min} :	0.57
Net weight:	24.9 kg
Gross weight:	27.8 kg
Shipping volume:	0.074 m ³
Danish VVS No.:	385912008
Norwegian NRF no.:	9040477
Country of origin:	HU
Custom tariff no.:	84137075

96517245 CRN 5-8 A-P-A-E-HQQE 50 Hz

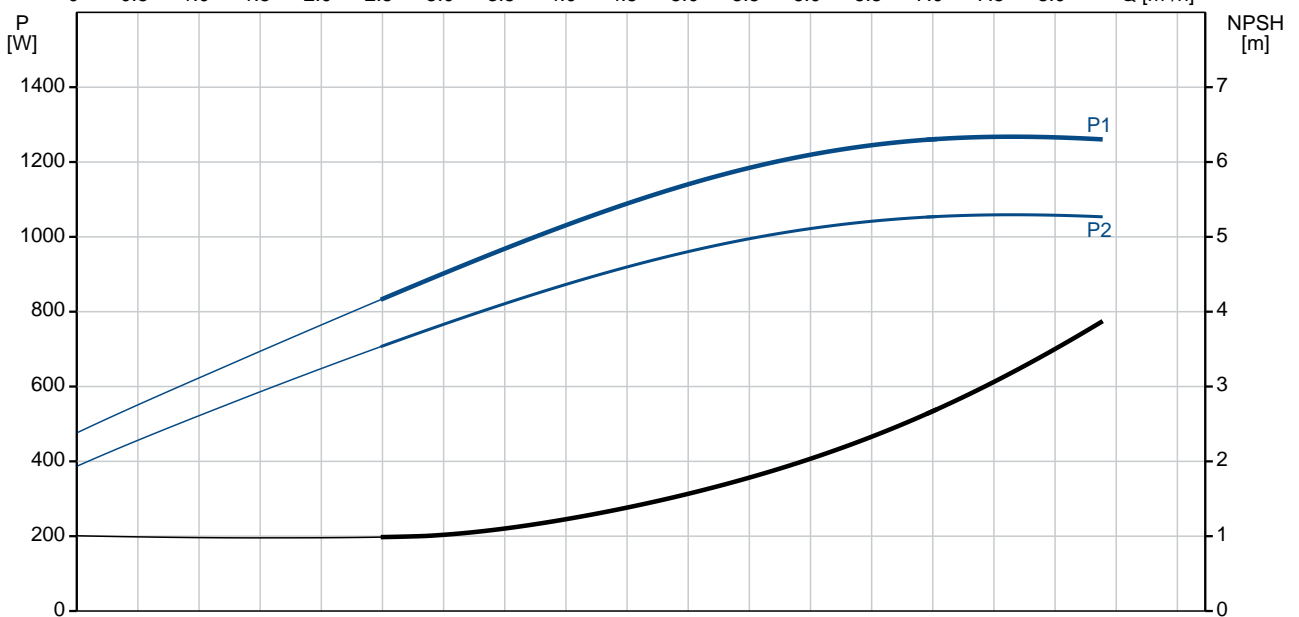
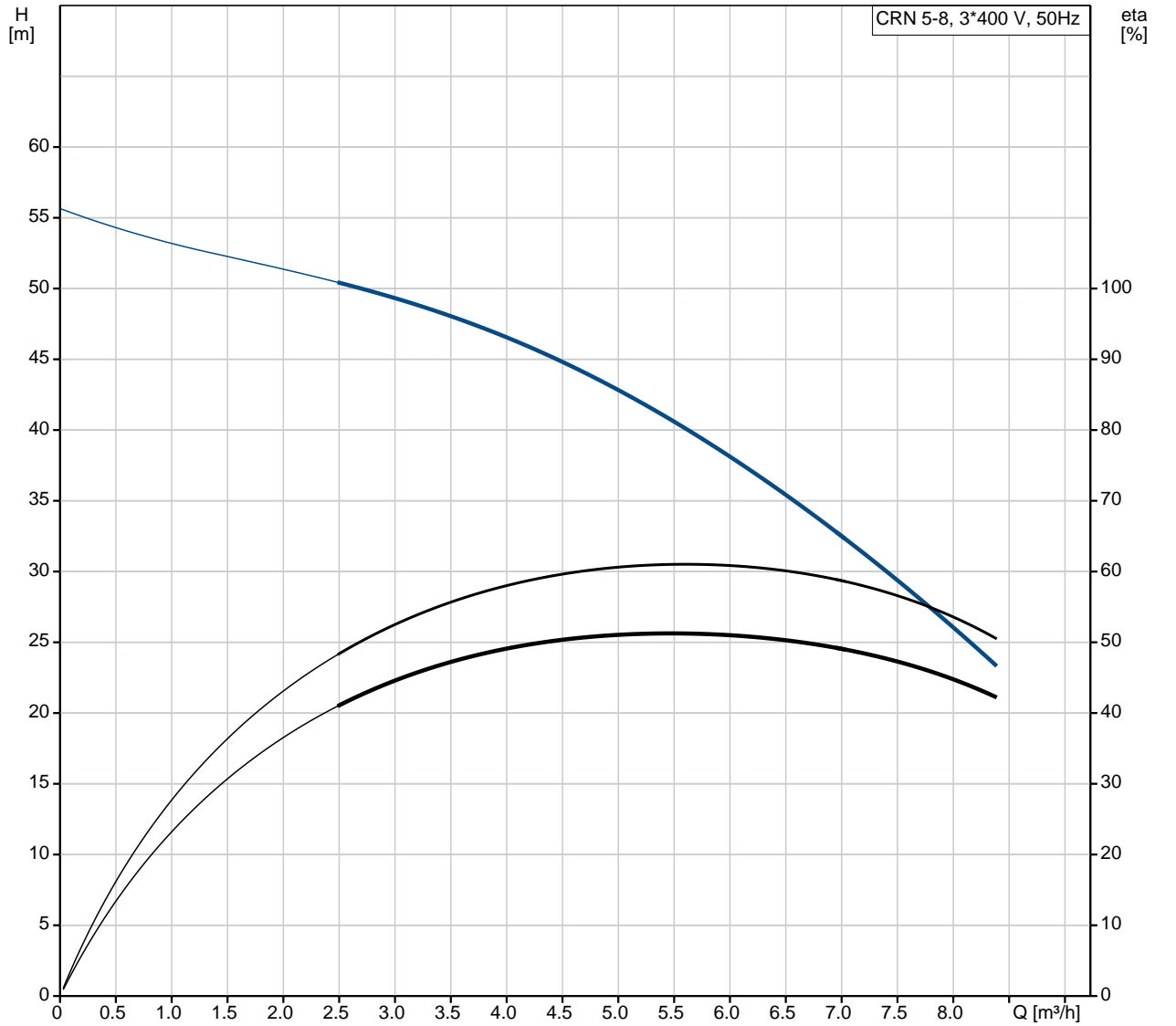

Description	Value
General information:	
Product name:	CRN 5-8 A-P-A-E-HQQE
Product No:	96517245
EAN number:	5700396759081
Price:	1.066,00 GBP
Technical:	
Pump speed on which pump data are based:	2853 rpm
Rated flow:	5.8 m ³ /h
Rated head:	40.3 m
Head max:	56.5 m
Stages:	8
Impellers:	8
Number of reduced-diameter impellers:	0
Low NPSH:	N
Pump orientation:	Vertical
Shaft seal arrangement:	Single
Code for shaft seal:	HQQE
Approvals on nameplate:	CE, EAC, ACS
Curve tolerance:	ISO9906:2012 3B
Pump version:	A
Model:	A
Materials:	
Base:	Stainless steel EN 1.4408 AISI 316
Impeller:	Stainless steel EN 1.4401 AISI 316
Material code:	A
Code for rubber:	E
Bearing:	SIC
Installation:	
Maximum ambient temperature:	60 °C
Maximum operating pressure:	25 bar
Max pressure at stated temp:	25 bar / 120 °C 25 bar / -20 °C
Type of connection:	PJE
Size of inlet connection:	DN 32 1 1/4 inch
Size of outlet connection:	DN 32 1 1/4 inch
Pressure rating for pipe connection:	PN 50
Flange size for motor:	FT100
Connect code:	P
Liquid:	
Pumped liquid:	Water
Liquid temperature range:	-20 .. 120 °C
Liquid temperature during operation:	20 °C
Density:	998.2 kg/m ³
Electrical data:	
Motor standard:	IEC
Motor type:	80C
IE Efficiency class:	IE3
Rated power - P2:	1.1 kW
Power (P2) required by pump:	1.1 kW
Mains frequency:	50 Hz

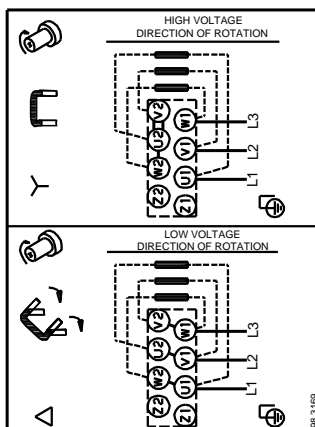
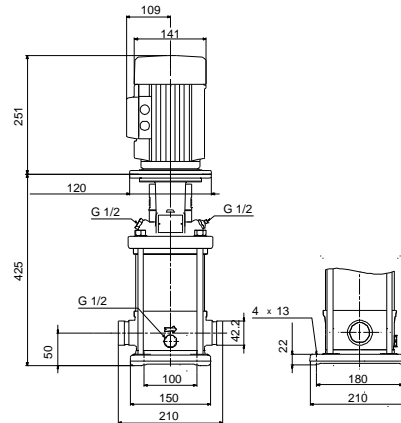
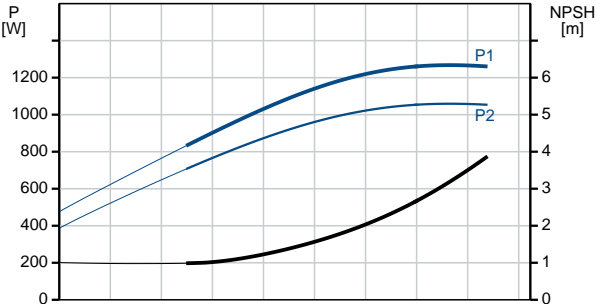
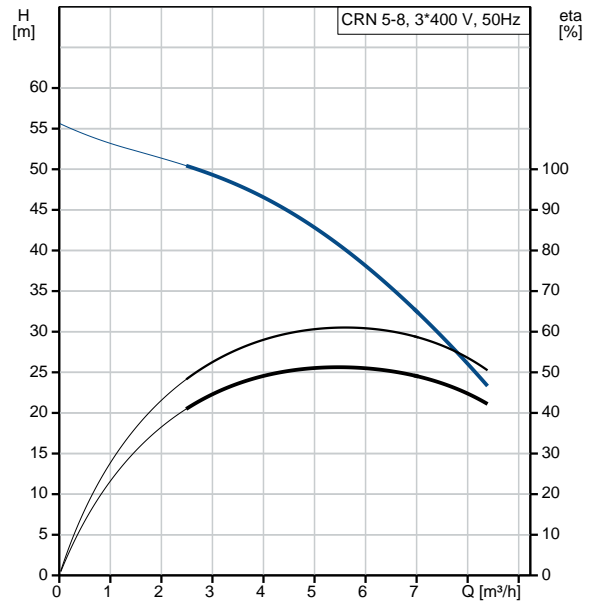

Description	Value
Rated voltage:	3 x 220-240D/380-415Y V
Rated current:	4.35/2.50 A
Starting current:	450-500 %
Cos phi - power factor:	0.83-0.76
Rated speed:	2840-2870 rpm
Efficiency:	IE3 82,7%
Motor efficiency at full load:	82.7 %
Motor efficiency at 3/4 load:	84.6 %
Motor efficiency at 1/2 load:	85.4 %
Number of poles:	2
Enclosure class (IEC 34-5):	55 Dust/Jetting
Insulation class (IEC 85):	F
Motor protec:	NONE
Motor No:	85U05105
Controls:	
Frequency converter:	NONE
Others:	
Minimum efficiency index, MEI $\hat{a}\%$ ¥:	0.57
Net weight:	24.9 kg
Gross weight:	27.8 kg
Shipping volume:	0.074 m ³
Danish VVS No.:	385912008
Norwegian NRF no.:	9040477
Country of origin:	HU
Custom tariff no.:	84137075

96517245 CRN 5-8 A-P-A-E-HQQE 50 Hz

