

Qty.	Description
1	<p data-bbox="199 338 497 367">CRN 3-12 A-P-A-E-HQQE</p>  <p data-bbox="199 660 469 689">Product No.: 96516904</p> <p data-bbox="199 719 1453 824">Vertical, multistage centrifugal pump with inlet and outlet ports on same the level (inline). Pump materials in contact with the liquid are in high-grade stainless steel. A cartridge shaft seal ensures high reliability, safe handling, and easy access and service. Power transmission is via a rigid split coupling. Pipe connection is via PJE (Victaulic®) couplings.</p> <p data-bbox="199 862 935 891">The pump is fitted with a 3-phase, fan-cooled asynchronous motor.</p> <p data-bbox="199 920 316 949">Controls:</p> <p data-bbox="199 952 638 981">Frequency converter: NONE</p> <p data-bbox="199 1010 288 1039">Liquid:</p> <p data-bbox="199 1041 707 1160">Pumped liquid: Water Liquid temperature range: -20 .. 120 °C Liquid temperature during operation: 20 °C Density: 998.2 kg/m³</p> <p data-bbox="199 1189 327 1218">Technical:</p> <p data-bbox="199 1220 820 1458">Pump speed on which pump data are based: 2853 rpm Rated flow: 3 m³/h Rated head: 57 m Pump orientation: Vertical Shaft seal arrangement: Single Code for shaft seal: HQQE Approvals on nameplate: CE, EAC, ACS Curve tolerance: ISO9906:2012 3B</p> <p data-bbox="199 1487 320 1516">Materials:</p> <p data-bbox="199 1518 727 1727">Base: Stainless steel EN 1.4408 AISI 316 Impeller: Stainless steel EN 1.4401 AISI 316 Bearing: SIC</p> <p data-bbox="199 1756 344 1785">Installation:</p> <p data-bbox="199 1787 742 2107">Maximum ambient temperature: 60 °C Maximum operating pressure: 25 bar Max pressure at stated temp: 25 bar / 120 °C 25 bar / -20 °C Type of connection: PJE Size of inlet connection: DN 32 1 1/4 inch Size of outlet connection: DN 32 1 1/4 inch Pressure rating for pipe connection: PN 50 Flange size for motor: FT100</p>

Qty.	Description
	<p>Electrical data:</p> <p>Motor standard: IEC</p> <p>Motor type: 80C</p> <p>IE Efficiency class: IE3</p> <p>Rated power - P2: 1.1 kW</p> <p>Power (P2) required by pump: 1.1 kW</p> <p>Mains frequency: 50 Hz</p> <p>Rated voltage: 3 x 220-240D/380-415Y V</p> <p>Rated current: 4.35/2.50 A</p> <p>Starting current: 450-500 %</p> <p>Cos phi - power factor: 0.83-0.76</p> <p>Rated speed: 2840-2870 rpm</p> <p>Efficiency: IE3 82,7%</p> <p>Motor efficiency at full load: 82.7 %</p> <p>Motor efficiency at 3/4 load: 84.6 %</p> <p>Motor efficiency at 1/2 load: 85.4 %</p> <p>Number of poles: 2</p> <p>Enclosure class (IEC 34-5): 55 Dust/Jetting</p> <p>Insulation class (IEC 85): F</p> <p>Others:</p> <p>Minimum efficiency index, MEI $\hat{\alpha}\%$: 0.70</p> <p>Net weight: 25.2 kg</p> <p>Gross weight: 28.1 kg</p> <p>Shipping volume: 0.074 m³</p> <p>Danish VVS No.: 385911012</p> <p>Norwegian NRF no.: 9040467</p> <p>Country of origin: HU</p> <p>Custom tariff no.: 84137075</p>

96516904 CRN 3-12 A-P-A-E-HQQE 50 Hz

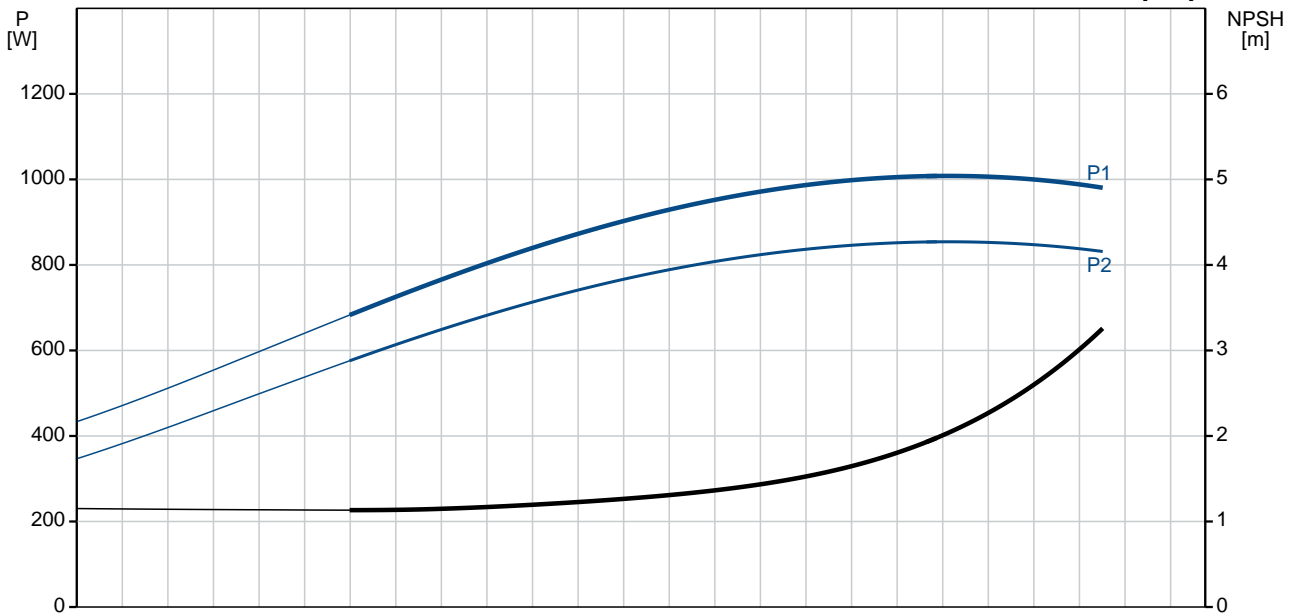
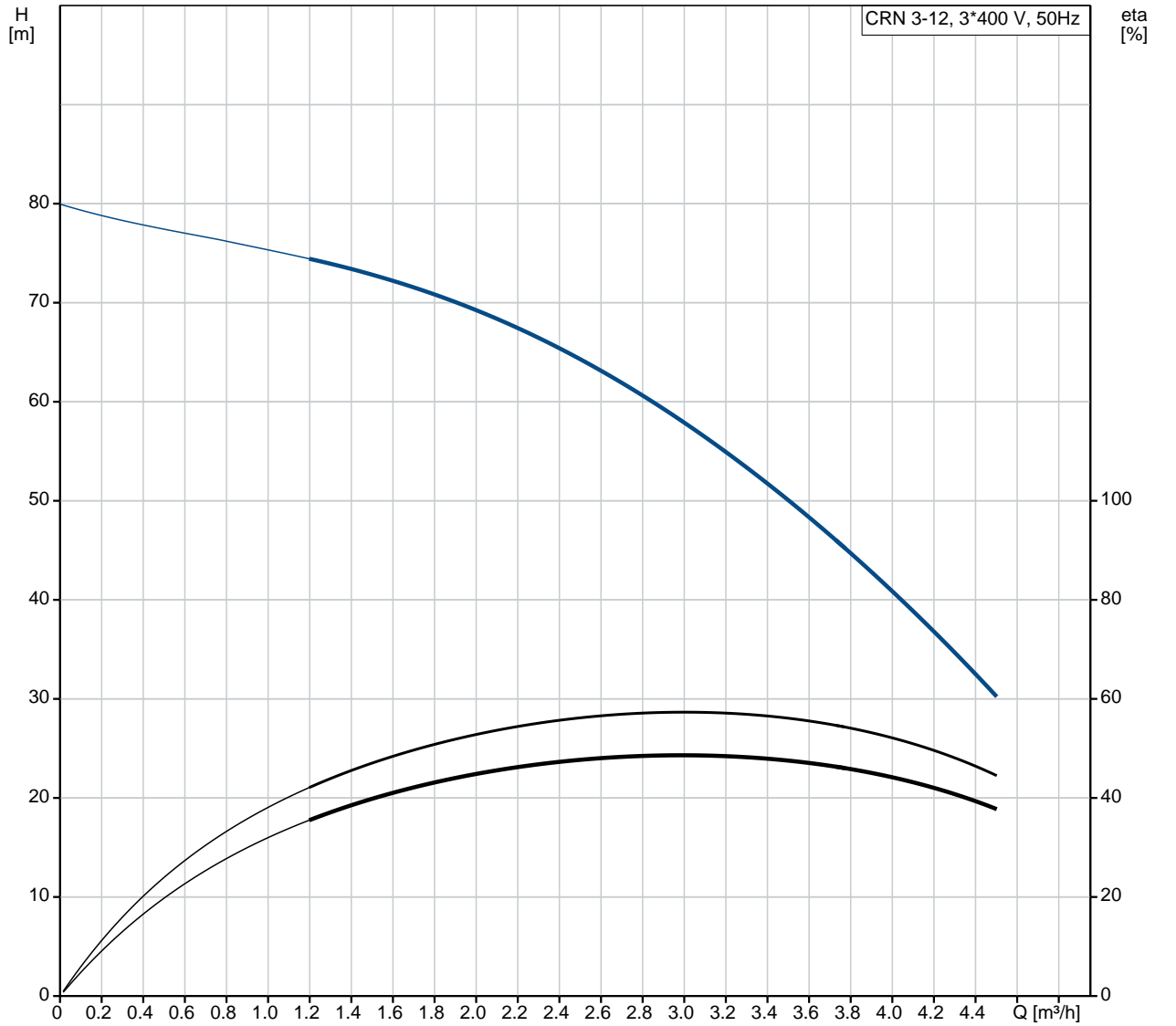

Description	Value
General information:	
Product name:	CRN 3-12 A-P-A-E-HQQE
Product No:	96516904
EAN number:	5700396752198
Price:	1.109,00 GBP
Technical:	
Pump speed on which pump data are based:	2853 rpm
Rated flow:	3 m ³ /h
Rated head:	57 m
Head max:	79.1 m
Stages:	12
Impellers:	12
Number of reduced-diameter impellers:	0
Low NPSH:	N
Pump orientation:	Vertical
Shaft seal arrangement:	Single
Code for shaft seal:	HQQE
Approvals on nameplate:	CE, EAC, ACS
Curve tolerance:	ISO9906:2012 3B
Pump version:	A
Model:	A
Materials:	
Base:	Stainless steel EN 1.4408 AISI 316
Impeller:	Stainless steel EN 1.4401 AISI 316
Material code:	A
Code for rubber:	E
Bearing:	SIC
Installation:	
Maximum ambient temperature:	60 °C
Maximum operating pressure:	25 bar
Max pressure at stated temp:	25 bar / 120 °C 25 bar / -20 °C
Type of connection:	PJE
Size of inlet connection:	DN 32 1 1/4 inch
Size of outlet connection:	DN 32 1 1/4 inch
Pressure rating for pipe connection:	PN 50
Flange size for motor:	FT100
Connect code:	P
Liquid:	
Pumped liquid:	Water
Liquid temperature range:	-20 .. 120 °C
Liquid temperature during operation:	20 °C
Density:	998.2 kg/m ³
Electrical data:	
Motor standard:	IEC
Motor type:	80C
IE Efficiency class:	IE3
Rated power - P2:	1.1 kW
Power (P2) required by pump:	1.1 kW
Mains frequency:	50 Hz

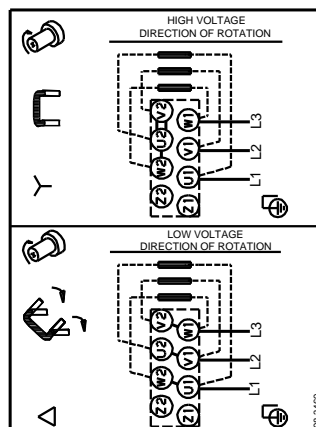
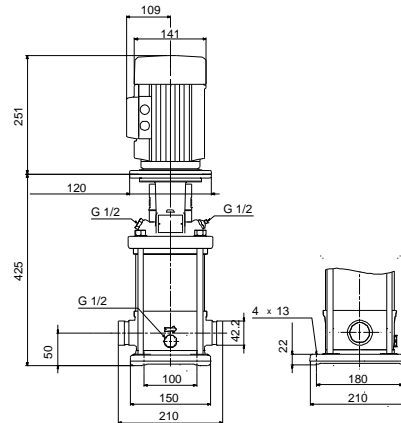
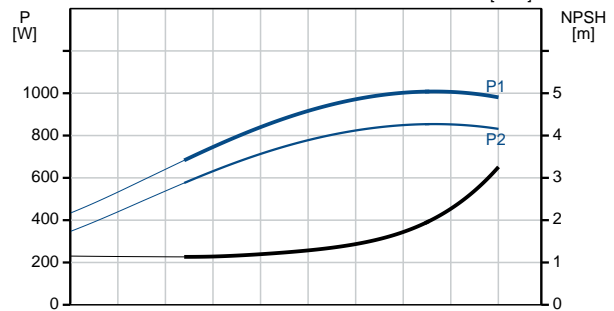
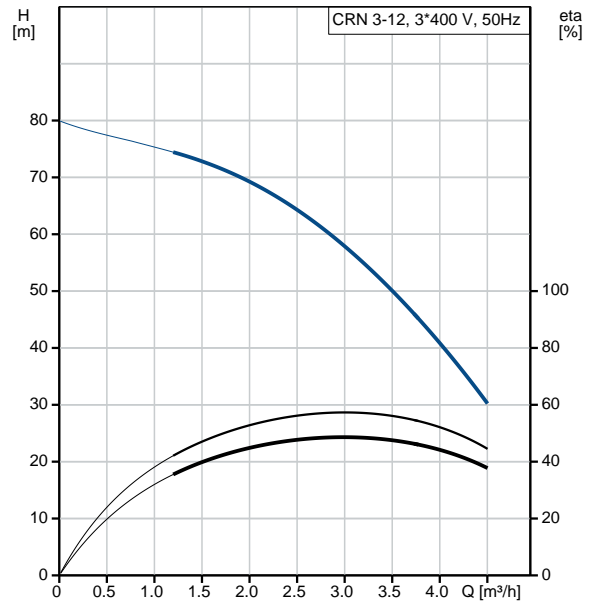



Company name:

Created by:

Phone:

Date:

07/03/2019

Description	Value
Rated voltage:	3 x 220-240D/380-415Y V
Rated current:	4.35/2.50 A
Starting current:	450-500 %
Cos phi - power factor:	0.83-0.76
Rated speed:	2840-2870 rpm
Efficiency:	IE3 82,7%
Motor efficiency at full load:	82.7 %
Motor efficiency at 3/4 load:	84.6 %
Motor efficiency at 1/2 load:	85.4 %
Number of poles:	2
Enclosure class (IEC 34-5):	55 Dust/Jetting
Insulation class (IEC 85):	F
Motor protec:	NONE
Motor No:	85U05105
Controls:	
Frequency converter:	NONE
Others:	
Minimum efficiency index, MEI $\hat{a}\%$ ¥:	0.70
Net weight:	25.2 kg
Gross weight:	28.1 kg
Shipping volume:	0.074 m ³
Danish VVS No.:	385911012
Norwegian NRF no.:	9040467
Country of origin:	HU
Custom tariff no.:	84137075

96516904 CRN 3-12 A-P-A-E-HQQE 50 Hz

