

Qty.	Description
1	<p data-bbox="199 336 502 369"><b>CRN 3-10 A-P-A-E-HQQE</b></p>  <p data-bbox="199 660 470 683">Product No.: <a href="#">96499188</a></p> <p data-bbox="199 716 1460 817">Vertical, multistage centrifugal pump with inlet and outlet ports on same the level (inline). Pump materials in contact with the liquid are in high-grade stainless steel. A cartridge shaft seal ensures high reliability, safe handling, and easy access and service. Power transmission is via a rigid split coupling. Pipe connection is via PJE (Victaulic®) couplings.</p> <p data-bbox="199 862 933 884">The pump is fitted with a 3-phase, fan-cooled asynchronous motor.</p> <p data-bbox="199 918 319 940"><b>Controls:</b></p> <p data-bbox="199 952 638 974">Frequency converter: NONE</p> <p data-bbox="199 1008 287 1030"><b>Liquid:</b></p> <p data-bbox="199 1041 638 1064">Pumped liquid: Water</p> <p data-bbox="199 1070 710 1093">Liquid temperature range: -20 .. 120 °C</p> <p data-bbox="199 1099 686 1122">Liquid temperature during operation: 20 °C</p> <p data-bbox="199 1128 702 1151">Density: 998.2 kg/m<sup>3</sup></p> <p data-bbox="199 1187 327 1209"><b>Technical:</b></p> <p data-bbox="199 1220 821 1243">Pump speed on which pump data are based: 2864 rpm</p> <p data-bbox="199 1249 638 1272">Rated flow: 3 m<sup>3</sup>/h</p> <p data-bbox="199 1279 646 1301">Rated head: 46.4 m</p> <p data-bbox="199 1308 646 1330">Pump orientation: Vertical</p> <p data-bbox="199 1337 638 1359">Shaft seal arrangement: Single</p> <p data-bbox="199 1366 638 1388">Code for shaft seal: HQQE</p> <p data-bbox="199 1395 726 1417">Approvals on nameplate: CE, EAC, ACS</p> <p data-bbox="199 1424 766 1447">Curve tolerance: ISO9906:2012 3B</p> <p data-bbox="199 1482 319 1505"><b>Materials:</b></p> <p data-bbox="199 1516 726 1601">Base: Stainless steel EN 1.4408 AISI 316</p> <p data-bbox="199 1608 726 1693">Impeller: Stainless steel EN 1.4401 AISI 316</p> <p data-bbox="199 1700 606 1722">Bearing: SIC</p> <p data-bbox="199 1758 343 1780"><b>Installation:</b></p> <p data-bbox="199 1787 630 1809">Maximum ambient temperature: 60 °C</p> <p data-bbox="199 1816 638 1839">Maximum operating pressure: 25 bar</p> <p data-bbox="199 1845 742 1899">Max pressure at stated temp: 25 bar / 120 °C 25 bar / -20 °C</p> <p data-bbox="199 1906 614 1928">Type of connection: PJE</p> <p data-bbox="199 1935 678 1989">Size of inlet connection: DN 32 1 1/4 inch</p> <p data-bbox="199 1995 678 2049">Size of outlet connection: DN 32 1 1/4 inch</p> <p data-bbox="199 2056 686 2078">Pressure rating for pipe connection: PN 50</p> <p data-bbox="199 2085 638 2107">Flange size for motor: FT100</p>

Qty.	Description
------	-------------

**Electrical data:**

Motor standard:	IEC
Motor type:	80A
IE Efficiency class:	IE3
Rated power - P2:	0.75 kW
Power (P2) required by pump:	0.75 kW
Mains frequency:	50 Hz
Rated voltage:	3 x 220-240D/380-415Y V
Rated current:	3.30/1.90 A
Starting current:	580-620 %
Cos phi - power factor:	0.81-0.71
Rated speed:	2840-2870 rpm
Efficiency:	IE3 80,7%
Motor efficiency at full load:	80.7 %
Motor efficiency at 3/4 load:	82.7 %
Motor efficiency at 1/2 load:	81.7 %
Number of poles:	2
Enclosure class (IEC 34-5):	55 Dust/Jetting
Insulation class (IEC 85):	F

**Others:**

Minimum efficiency index, MEI $\hat{\alpha}\%$ :	0.70
Net weight:	22.4 kg
Gross weight:	25.3 kg
Shipping volume:	0.074 m <sup>3</sup>
Danish VVS No.:	385911010
Country of origin:	GB
Custom tariff no.:	84137075

## 96499188 CRN 3-10 A-P-A-E-HQQE 50 Hz

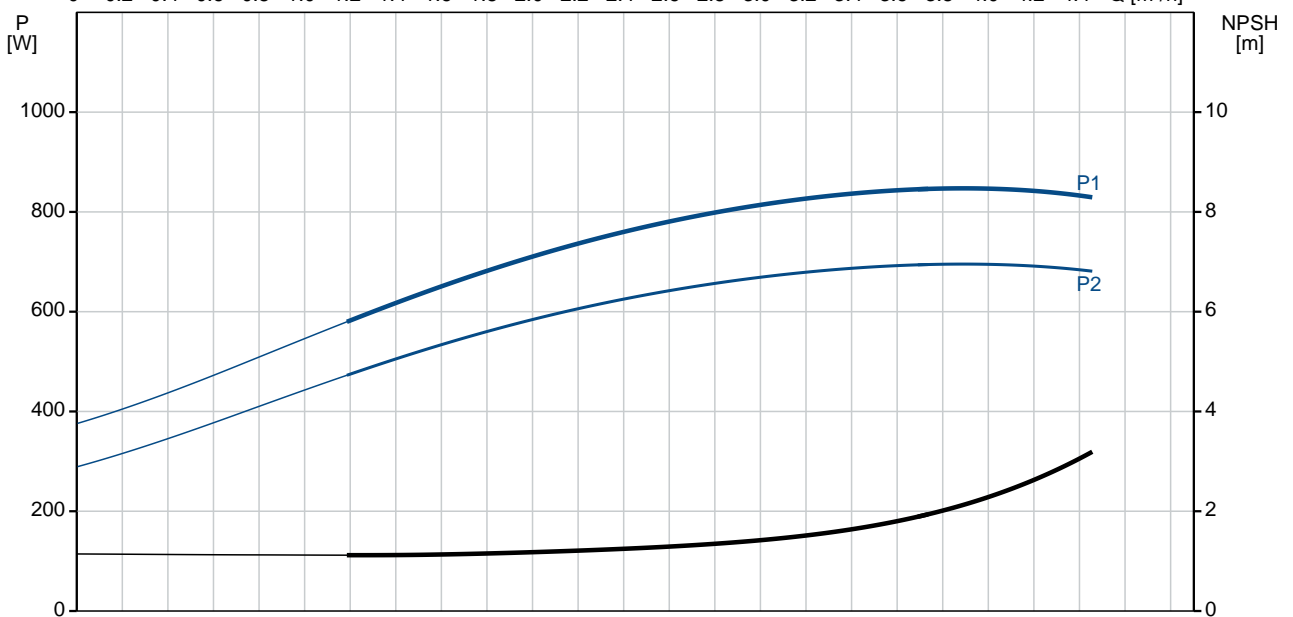
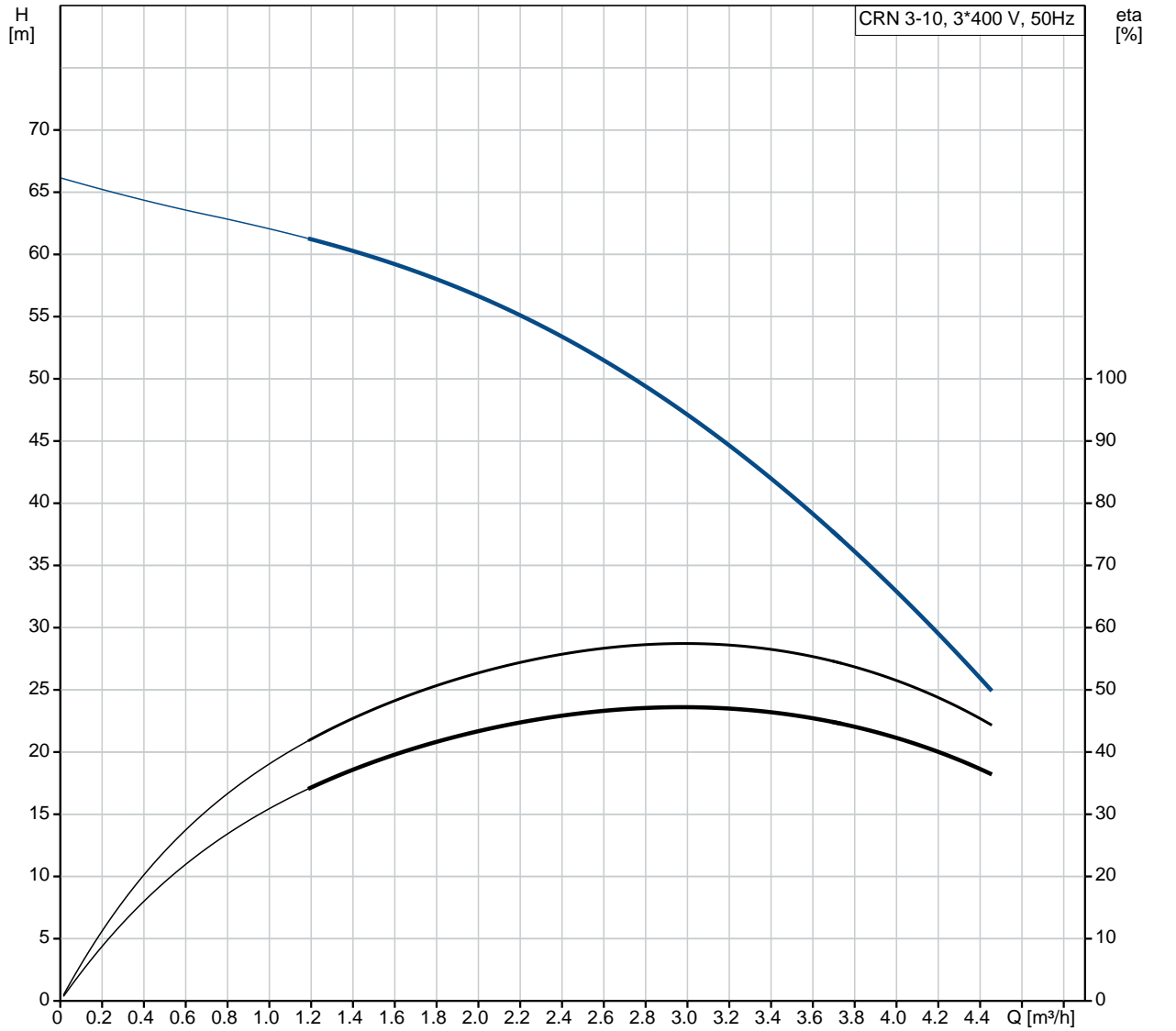

Description	Value
<b>General information:</b>	
Product name:	CRN 3-10 A-P-A-E-HQQE
Product No:	96499188
EAN number:	5700396167947
Price:	1.006,00 GBP
<b>Technical:</b>	
Pump speed on which pump data are based:	2864 rpm
Rated flow:	3 m <sup>3</sup> /h
Rated head:	46.4 m
Head max:	65.6 m
Stages:	10
Impellers:	10
Number of reduced-diameter impellers:	0
Low NPSH:	N
Pump orientation:	Vertical
Shaft seal arrangement:	Single
Code for shaft seal:	HQQE
Approvals on nameplate:	CE, EAC, ACS
Curve tolerance:	ISO9906:2012 3B
Pump version:	A
Model:	A
<b>Materials:</b>	
Base:	Stainless steel EN 1.4408 AISI 316
Impeller:	Stainless steel EN 1.4401 AISI 316
Material code:	A
Code for rubber:	E
Bearing:	SIC
<b>Installation:</b>	
Maximum ambient temperature:	60 °C
Maximum operating pressure:	25 bar
Max pressure at stated temp:	25 bar / 120 °C 25 bar / -20 °C
Type of connection:	PJE
Size of inlet connection:	DN 32 1 1/4 inch
Size of outlet connection:	DN 32 1 1/4 inch
Pressure rating for pipe connection:	PN 50
Flange size for motor:	FT100
Connect code:	P
<b>Liquid:</b>	
Pumped liquid:	Water
Liquid temperature range:	-20 .. 120 °C
Liquid temperature during operation:	20 °C
Density:	998.2 kg/m <sup>3</sup>
<b>Electrical data:</b>	
Motor standard:	IEC
Motor type:	80A
IE Efficiency class:	IE3
Rated power - P2:	0.75 kW
Power (P2) required by pump:	0.75 kW
Mains frequency:	50 Hz

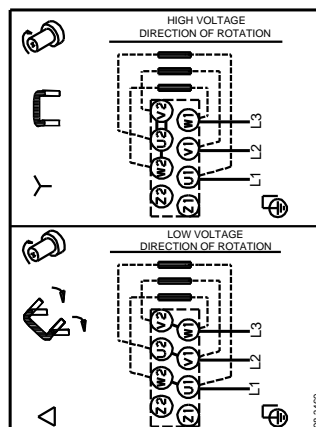
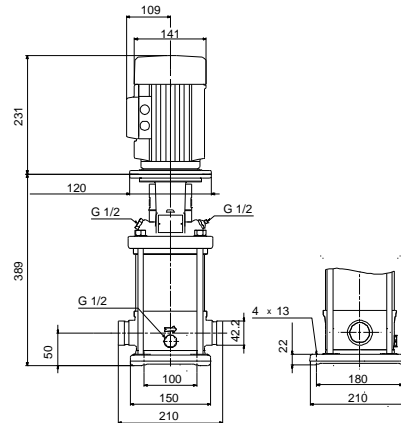
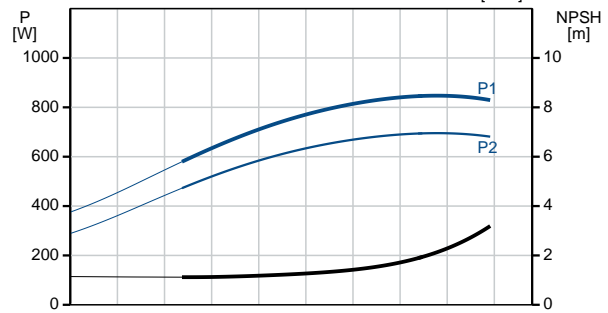
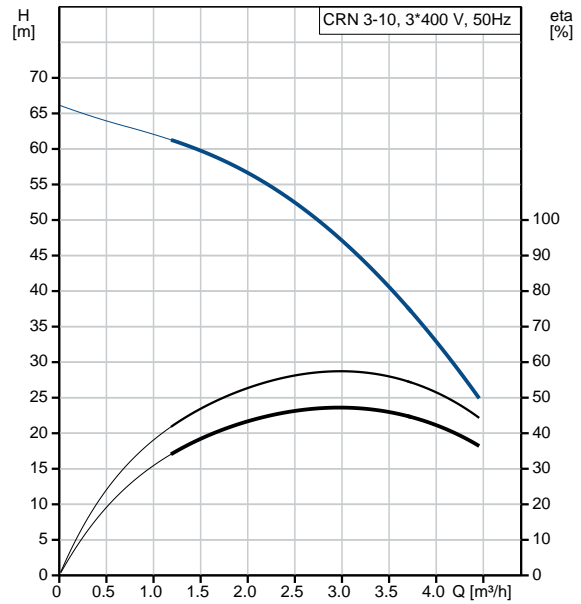



Company name:

Created by:

Phone:

Date:

07/03/2019

Description	Value
Rated voltage:	3 x 220-240D/380-415Y V
Rated current:	3.30/1.90 A
Starting current:	580-620 %
Cos phi - power factor:	0.81-0.71
Rated speed:	2840-2870 rpm
Efficiency:	IE3 80,7%
Motor efficiency at full load:	80.7 %
Motor efficiency at 3/4 load:	82.7 %
Motor efficiency at 1/2 load:	81.7 %
Number of poles:	2
Enclosure class (IEC 34-5):	55 Dust/Jetting
Insulation class (IEC 85):	F
Motor protec:	NONE
Motor No:	85U05104
<b>Controls:</b>	
Frequency converter:	NONE
<b>Others:</b>	
Minimum efficiency index, MEI $\hat{a}\%$ ¥:	0.70
Net weight:	22.4 kg
Gross weight:	25.3 kg
Shipping volume:	0.074 m <sup>3</sup>
Danish VVS No.:	385911010
Country of origin:	GB
Custom tariff no.:	84137075

## 96499188 CRN 3-10 A-P-A-E-HQQE 50 Hz

