

Qty.	Description
1	<p data-bbox="199 336 351 369">SP 300-1A G</p>  <p data-bbox="590 772 1077 795" style="text-align: center;">Note! Product picture may differ from actual product</p> <p data-bbox="199 801 470 828">Product No.: 96430983</p> <p data-bbox="199 833 1452 884">Multi-stage submersible pump for raw water supply, groundwater lowering, pressure boosting and various industrial jobs.</p> <p data-bbox="199 889 1284 918">The pump is suitable for pumping clean, thin, non-aggressive liquids without solid particles or fibres.</p> <p data-bbox="199 952 1428 996">Pump: The pump is made entirely of Cast iron DIN W.-Nr. EN-JL1040 and suitable for horizontal installation.</p> <p data-bbox="199 1008 742 1034">The pump is fitted with a built-in non-return valve.</p> <p data-bbox="199 1068 1412 1120">Phase: The motor is a 3-phase motor with sand shield, liquid-lubricated bearings and pressure equalizing diaphragm.</p> <p data-bbox="199 1124 1069 1153">Performance test according to ISO9906 2012 Grade 3B is available on request.</p> <p data-bbox="199 1182 702 1361">Liquid: Pumped liquid: Water Maximum liquid temperature: 40 °C Max liquid t at 0.15 m/sec: 25 °C Selected liquid temperature: 20 °C Density: 998.2 kg/m³</p> <p data-bbox="199 1393 766 1541">Technical: Type of impeller: A Shaft seal for motor: CER/CARBON Curve tolerance: ISO9906:2012 3B Motor version: T30</p> <p data-bbox="199 1572 805 1809">Materials: Pump: Cast iron EN-JL1040 Impeller: Zinc-free bronze DIN W.-Nr. 2.1050.01 Motor: Cast iron DIN W.-Nr. 0.6025 ASTM 35-40</p> <p data-bbox="199 1841 638 1960">Installation: Flange standard: DIN Pump outlet: DN175 Motor diameter: 8 inch</p> <p data-bbox="199 1991 678 2105">Electrical data: Motor type: MMS8000 Rated power - P2: 45 kW Mains frequency: 50 Hz</p>



Company name:

Created by:

Phone:

Date:

12/11/2020

Qty.	Description
------	-------------

Rated voltage:	3 x 380-400-415 V
Rated current:	95.5-96.5-96.0 A
Cos phi - power factor:	0.88-0.82-0.80
Rated speed:	2900-2910-2920 rpm
Start. method:	direct-on-line
Enclosure class (IEC 34-5):	IP68
Built-in temp. transmitter:	no
Motor No:	96430671
Windings:	PVC

Others:	
Net weight:	317 kg
Shipping volume:	0.455 m ³
Country of origin:	IT
Custom tariff no.:	84137029

96430983 SP 300-1A G 50 Hz

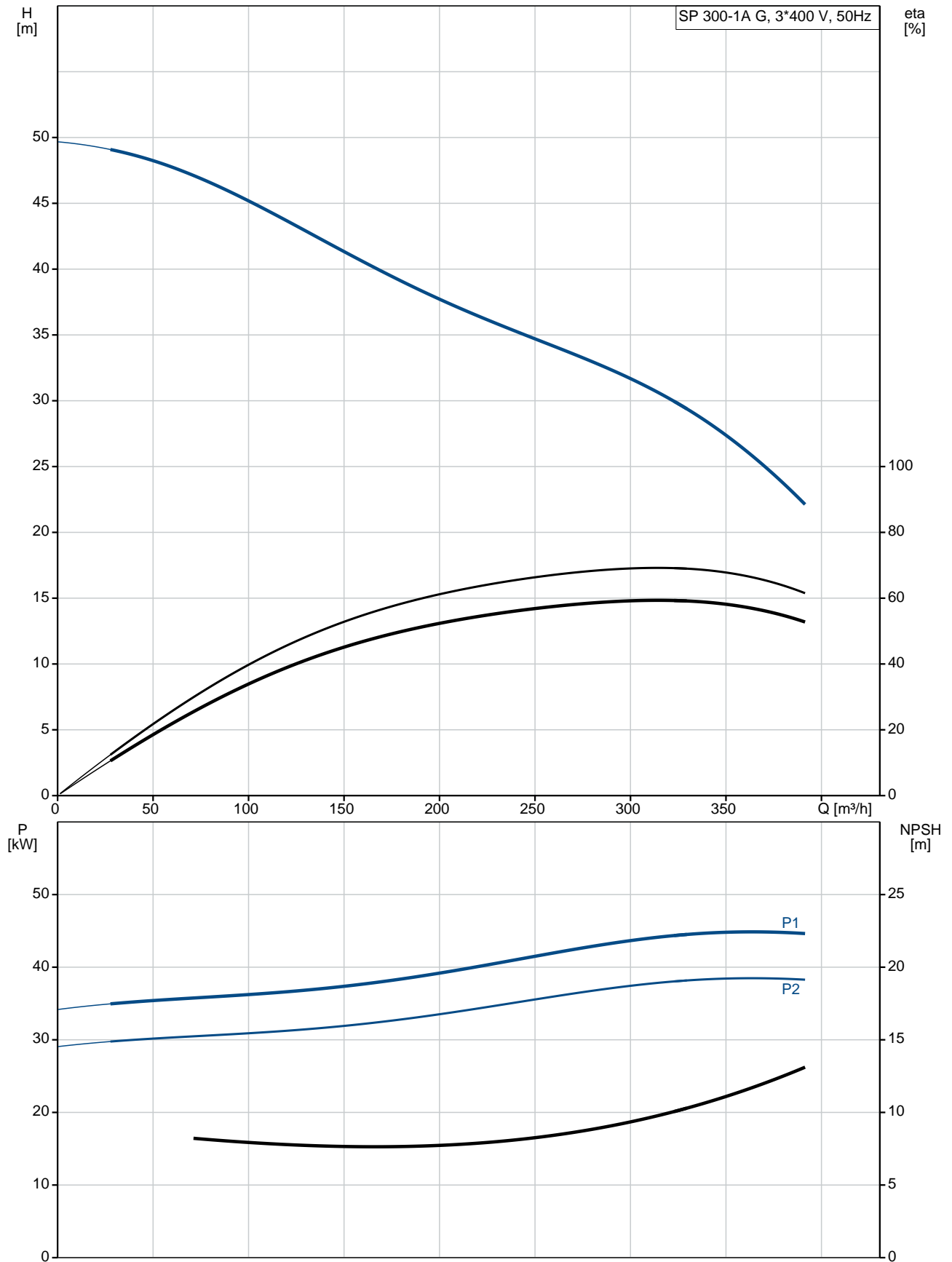

Description	Value
General information:	
Product name:	SP 300-1A G
Product No:	96430983
EAN number:	5700393033184
Technical:	
Stages:	1
Type of impeller:	A
Shaft seal for motor:	CER/CARBON
Curve tolerance:	ISO9906:2012 3B
Pump No:	96430886
Valve:	pump with built-in non-return valve
Motor version:	T30
Materials:	
Pump:	Cast iron
Pump:	EN-JL1040
Impeller:	Zinc-free bronze
Impeller:	DIN W.-Nr. 2.1050.01
Motor:	Cast iron
Motor:	DIN W.-Nr. 0.6025
Motor:	ASTM 35-40
Installation:	
Flange standard:	DIN
Pump outlet:	DN175
Motor diameter:	8 inch
Liquid:	
Pumped liquid:	Water
Maximum liquid temperature:	40 °C
Max liquid t at 0.15 m/sec:	25 °C
Selected liquid temperature:	20 °C
Density:	998.2 kg/m ³
Electrical data:	
Motor type:	MMS8000
Applic. motor:	GRUNDFOS
Rated power - P2:	45 kW
Mains frequency:	50 Hz
Rated voltage:	3 x 380-400-415 V
Rated current:	95.5-96.5-96.0 A
Cos phi - power factor:	0.88-0.82-0.80
Rated speed:	2900-2910-2920 rpm
Start. method:	direct-on-line
Enclosure class (IEC 34-5):	IP68
Motor protec:	NONE
Thermal protec:	external
Built-in temp. transmitter:	no
Motor No:	96430671
Windings:	PVC
Others:	
Net weight:	317 kg
Shipping volume:	0.455 m ³
Country of origin:	IT
Custom tariff no.:	84137029

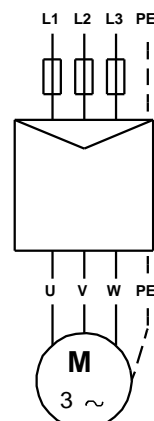
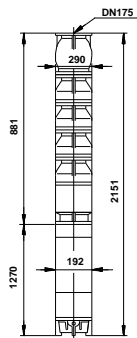
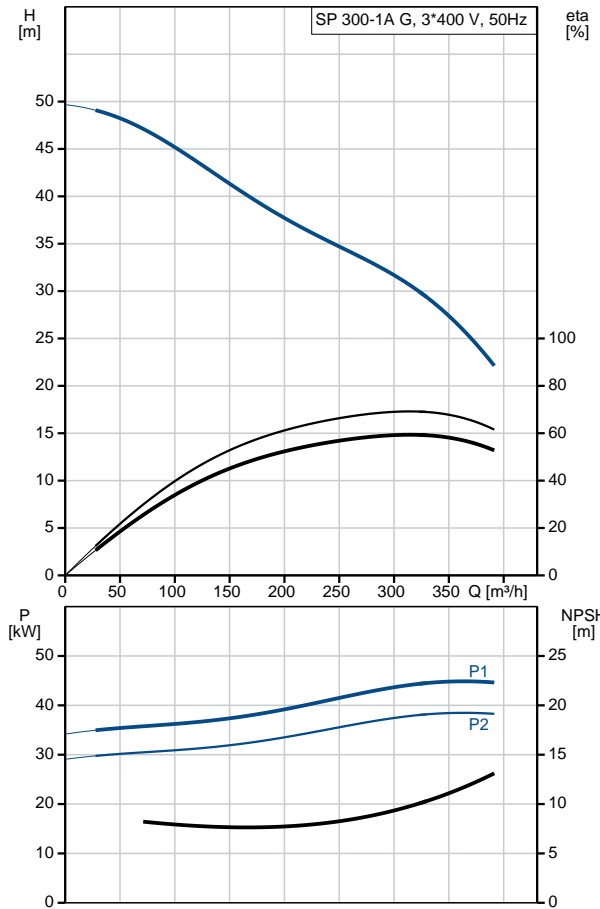

96430983 SP 300-1A G 50 Hz

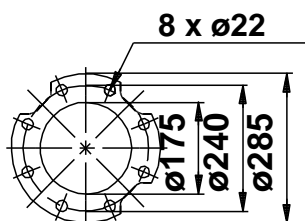
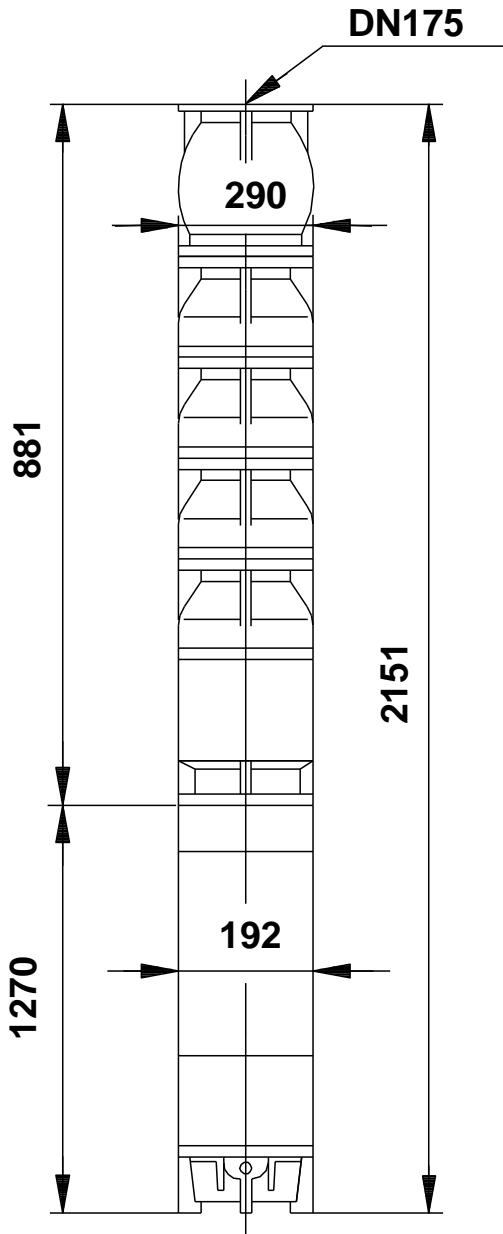

Note! All units are in [mm] unless others are stated.
Disclaimer: This simplified dimensional drawing does not show all details.

96430983 SP 300-1A G 50 Hz

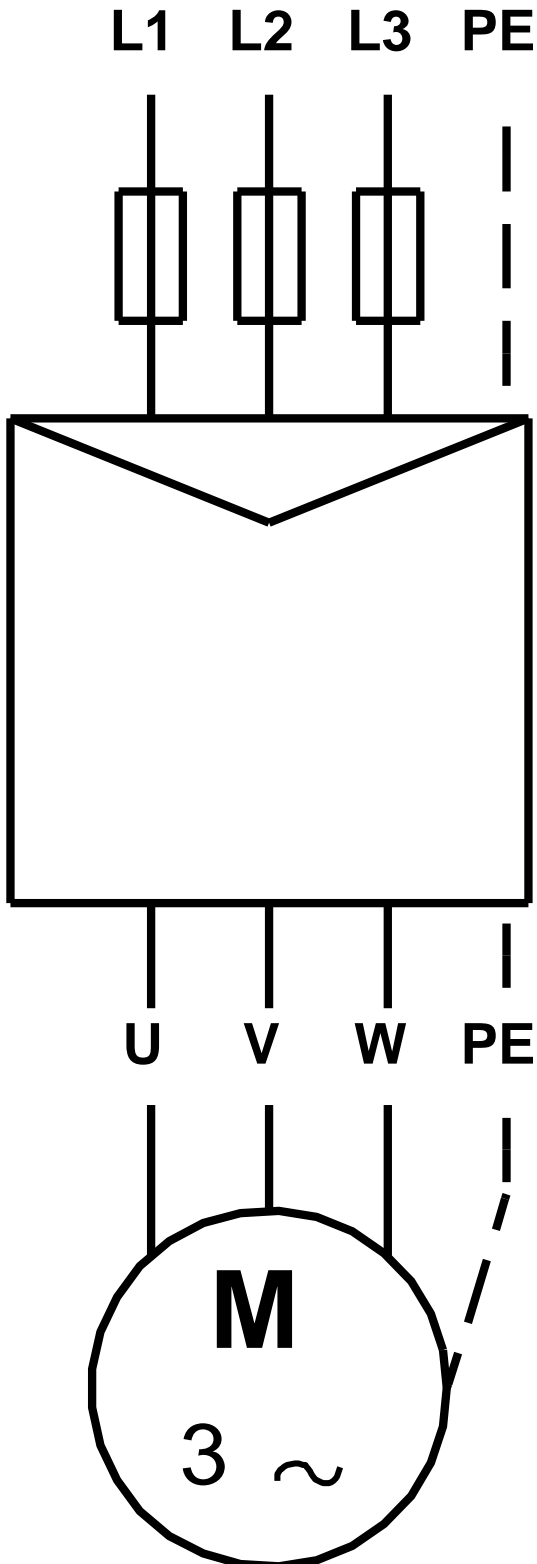

Note! All units are in [mm] unless others are stated.