

Qty. Description

1 SEV.65.80.30.A.EX.2.50D



Note! Product picture may differ from actual product

Product No.: [96177701](#)

Non-self-priming, single-stage, centrifugal pump designed for handling wastewater, process water and unscreened raw sewage.

The pump is designed for intermittent and continuous operation. The liquidless and maintenance free cooling system ensures that the pump can be used for submerged or dry installation. The efficient SuperVortex impeller provides passage of long fibres and solids up to 65 mm and is suitable for wastewater with a dry matter content of up to 5 %.

A unique stainless-steel clamp assembling system enables quick and easy disassembly of the pump from the motor unit for service and inspection. No special tools are required. Pipework connection is via a DIN flange. The pump is explosion-proof.

Controls:

Moisture sensor: with moisture sensors
 Water-in-oil sensor: with water-in-oil sensor
 Temp. sensor: Y

Liquid:

Liquid temperature range: 0 .. 40 °C
 Density: 998.2 kg/m³

Technical:

Type of impeller: SUPER VORTEX
 Maximum particle size: 65 mm
 Primary shaft seal: SIC/SIC
 Secondary shaft seal: CARBON/CERAMICS
 Max. hydraulic efficiency: 34 %
 Approvals on nameplate: EN12050-1
 Curve tolerance: ISO9906:2012 3B2

Materials:

Pump housing: EN 1561 EN-GJL-250
 Impeller: Cast iron

Installation:

Maximum ambient temperature: 40 °C
 Maximum operating pressure: 6 bar
 Flange standard: DIN
 Pump outlet: DN 80
 Pressure rating: PN 10
 Maximum installation depth: 20 m

Electrical data:

Power input - P1: 3.8 kW
 Rated power - P2: 3 kW
 Mains frequency: 50 Hz
 Rated voltage: 3 x 380-415 V
 Voltage tolerance: +6/-10 %

Qty.	Description																																																												
	<table> <tr><td>Max starts per. hour:</td><td>20</td></tr> <tr><td>Rated current:</td><td>6.8-6.5 A</td></tr> <tr><td>Rated current at 3/4 load:</td><td>5 A</td></tr> <tr><td>Rated current at 1/2 load:</td><td>3.9 A</td></tr> <tr><td>Starting current:</td><td>51 A</td></tr> <tr><td>Rated current at no load:</td><td>2.5 A</td></tr> <tr><td>Cos phi - power factor:</td><td>0.87</td></tr> <tr><td>Cos phi - p.f. at no load:</td><td>0.22</td></tr> <tr><td>Cos phi - p.f. at 3/4 load:</td><td>0.83</td></tr> <tr><td>Cos phi - p.f. at 1/2 load:</td><td>0.74</td></tr> <tr><td>Rated speed:</td><td>2910 rpm</td></tr> <tr><td>Locked-rotor torque:</td><td>23 Nm</td></tr> <tr><td>Breakdown torque:</td><td>33 Nm</td></tr> <tr><td>Moment of inertia:</td><td>0.0098 kg m²</td></tr> <tr><td>Motor efficiency at full load:</td><td>79.6 %</td></tr> <tr><td>Motor efficiency at 3/4 load:</td><td>78.5 %</td></tr> <tr><td>Motor efficiency at 1/2 load:</td><td>75.1 %</td></tr> <tr><td>Number of poles:</td><td>2</td></tr> <tr><td>Start. method:</td><td>direct-on-line</td></tr> <tr><td>Enclosure class (IEC 34-5):</td><td>IP68</td></tr> <tr><td>Insulation class (IEC 85):</td><td>F</td></tr> <tr><td>Explosion proof:</td><td>yes</td></tr> <tr><td>Ex-protection standard:</td><td>Ex cd mb IIB T4,T3</td></tr> <tr><td>Length of cable:</td><td>10 m</td></tr> <tr><td>Cable type:</td><td>LYNIFLEX</td></tr> <tr><td>Type of cable plug:</td><td>NO PLUG</td></tr> <tr><td colspan="2">Others:</td></tr> <tr><td>Net weight:</td><td>94 kg</td></tr> <tr><td>Country of origin:</td><td>HU</td></tr> <tr><td>Custom tariff no.:</td><td>84137021</td></tr> </table>	Max starts per. hour:	20	Rated current:	6.8-6.5 A	Rated current at 3/4 load:	5 A	Rated current at 1/2 load:	3.9 A	Starting current:	51 A	Rated current at no load:	2.5 A	Cos phi - power factor:	0.87	Cos phi - p.f. at no load:	0.22	Cos phi - p.f. at 3/4 load:	0.83	Cos phi - p.f. at 1/2 load:	0.74	Rated speed:	2910 rpm	Locked-rotor torque:	23 Nm	Breakdown torque:	33 Nm	Moment of inertia:	0.0098 kg m ²	Motor efficiency at full load:	79.6 %	Motor efficiency at 3/4 load:	78.5 %	Motor efficiency at 1/2 load:	75.1 %	Number of poles:	2	Start. method:	direct-on-line	Enclosure class (IEC 34-5):	IP68	Insulation class (IEC 85):	F	Explosion proof:	yes	Ex-protection standard:	Ex cd mb IIB T4,T3	Length of cable:	10 m	Cable type:	LYNIFLEX	Type of cable plug:	NO PLUG	Others:		Net weight:	94 kg	Country of origin:	HU	Custom tariff no.:	84137021
Max starts per. hour:	20																																																												
Rated current:	6.8-6.5 A																																																												
Rated current at 3/4 load:	5 A																																																												
Rated current at 1/2 load:	3.9 A																																																												
Starting current:	51 A																																																												
Rated current at no load:	2.5 A																																																												
Cos phi - power factor:	0.87																																																												
Cos phi - p.f. at no load:	0.22																																																												
Cos phi - p.f. at 3/4 load:	0.83																																																												
Cos phi - p.f. at 1/2 load:	0.74																																																												
Rated speed:	2910 rpm																																																												
Locked-rotor torque:	23 Nm																																																												
Breakdown torque:	33 Nm																																																												
Moment of inertia:	0.0098 kg m ²																																																												
Motor efficiency at full load:	79.6 %																																																												
Motor efficiency at 3/4 load:	78.5 %																																																												
Motor efficiency at 1/2 load:	75.1 %																																																												
Number of poles:	2																																																												
Start. method:	direct-on-line																																																												
Enclosure class (IEC 34-5):	IP68																																																												
Insulation class (IEC 85):	F																																																												
Explosion proof:	yes																																																												
Ex-protection standard:	Ex cd mb IIB T4,T3																																																												
Length of cable:	10 m																																																												
Cable type:	LYNIFLEX																																																												
Type of cable plug:	NO PLUG																																																												
Others:																																																													
Net weight:	94 kg																																																												
Country of origin:	HU																																																												
Custom tariff no.:	84137021																																																												

96177701 SEV.65.80.30.A.EX.2.50D 50 Hz

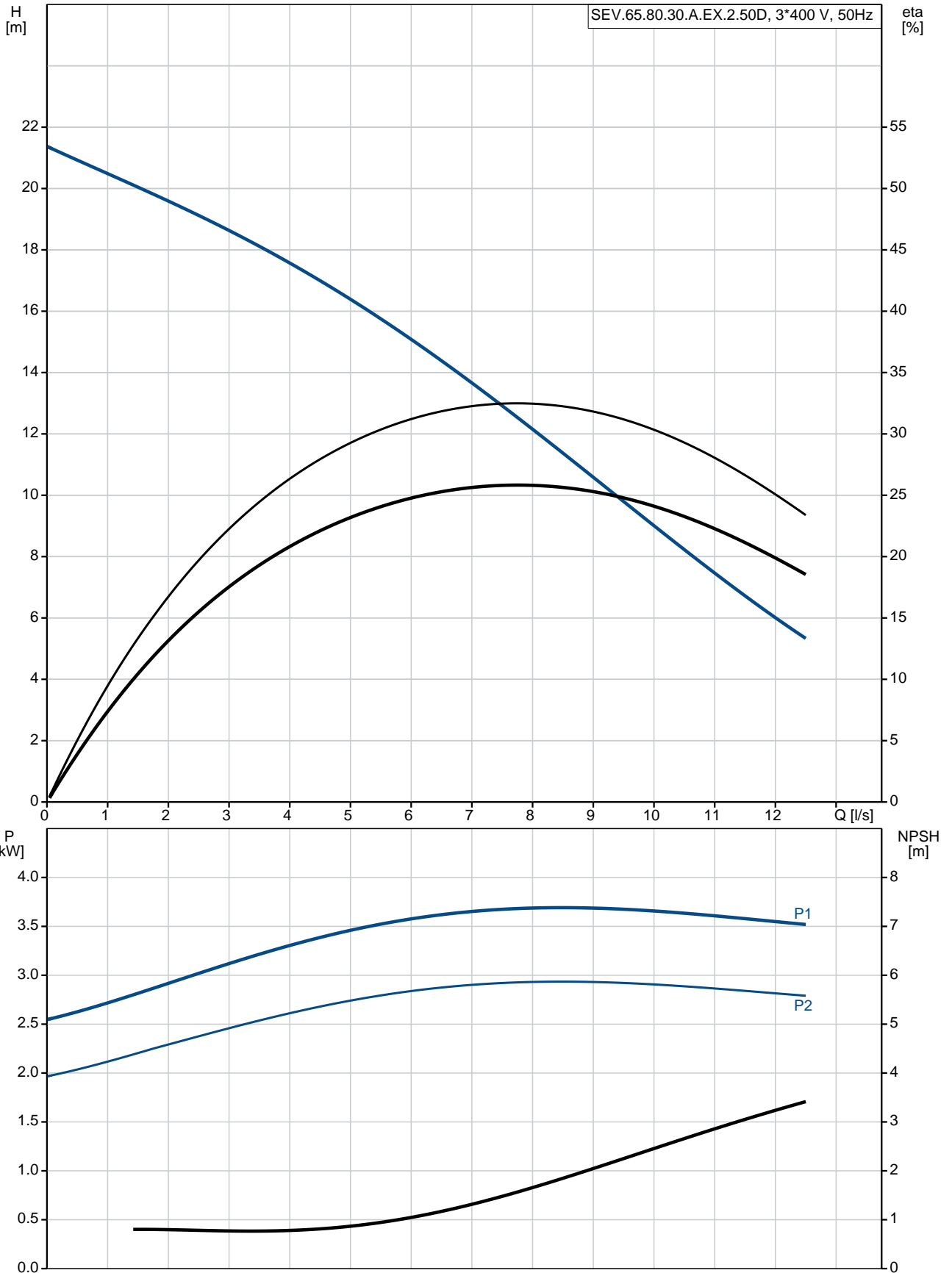

Description	Value
General information:	
Product name:	SEV.65.80.30.A.EX.2.50D
Product No:	96177701
EAN number:	5700830443477
	5700830443477
Price:	3.709,00 GBP
Technical:	
Max flow:	12.5 l/s
Head max:	21.4 m
Type of impeller:	SUPER VORTEX
Maximum particle size:	65 mm
Primary shaft seal:	SIC/SIC
Secondary shaft seal:	CARBON/CERAMICS
Max. hydraulic efficiency:	34 %
Approvals on nameplate:	EN12050-1
Curve tolerance:	ISO9906:2012 3B2
Cooling jacket:	with cooling jacket
Materials:	
Pump housing:	EN 1561 EN-GJL-250
Impeller:	Cast iron
Installation:	
Maximum ambient temperature:	40 °C
Maximum operating pressure:	6 bar
Flange standard:	DIN
Pump outlet:	DN 80
Pressure rating:	PN 10
Maximum installation depth:	20 m
Inst dry/wet:	DRY/SUBMERGED
Installation:	horizontal or vertical
Liquid:	
Liquid temperature range:	0 .. 40 °C
Density:	998.2 kg/m ³
Electrical data:	
Power input - P1:	3.8 kW
Rated power - P2:	3 kW
Mains frequency:	50 Hz
Rated voltage:	3 x 380-415 V
Voltage tolerance:	+6/-10 %
Max starts per. hour:	20
Rated current:	6.8-6.5 A
Rated current at 3/4 load:	5 A
Rated current at 1/2 load:	3.9 A
Starting current:	51 A
Rated current at no load:	2.5 A
Cos phi - power factor:	0.87
Cos phi - p.f. at no load:	0.22
Cos phi - p.f. at 3/4 load:	0.83
Cos phi - p.f. at 1/2 load:	0.74
Rated speed:	2910 rpm
Locked-rotor torque:	23 Nm
Breakdown torque:	33 Nm
Moment of inertia:	0.0098 kg m ²
Motor efficiency at full load:	79.6 %
Motor efficiency at 3/4 load:	78.5 %
Motor efficiency at 1/2 load:	75.1 %
Number of poles:	2
Start. method:	direct-on-line
Enclosure class (IEC 34-5):	IP68

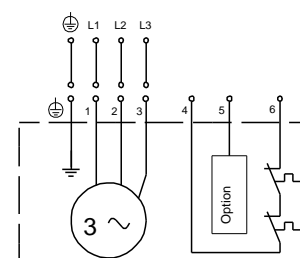
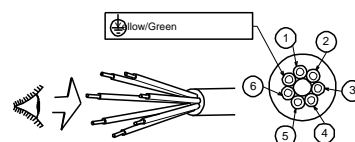
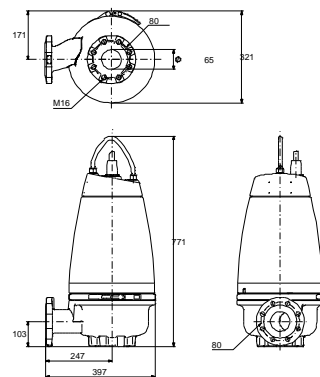
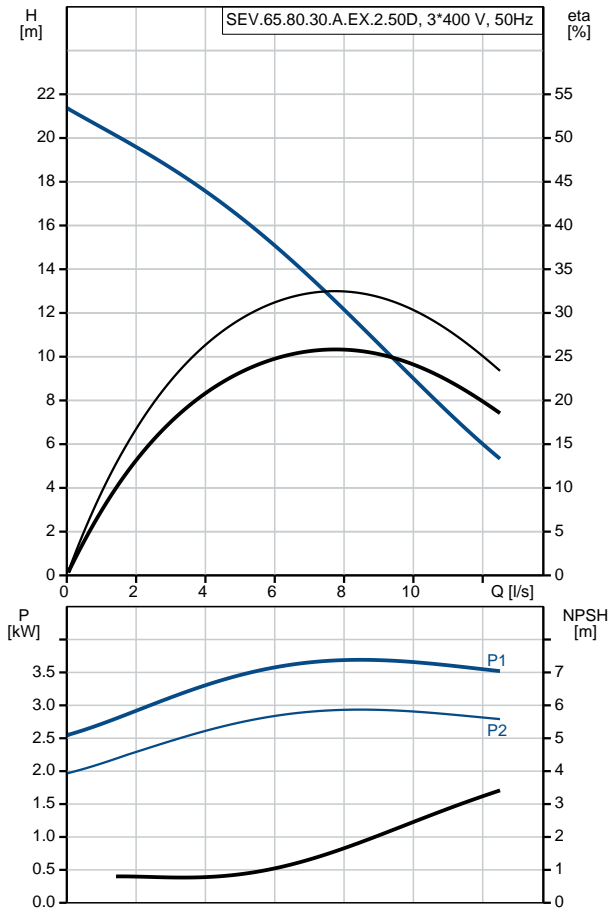



Company name:

Created by:

Phone:

Date: 28/01/2020

Description	Value
Insulation class (IEC 85):	F
Explosion proof:	yes
Ex-protection standard:	Ex cd mb IIB T4,T3
Motor protec:	THERMAL SWITCH
Thermal protec:	internal
Length of cable:	10 m
Cable type:	LYNIFLEX
Type of cable plug:	NO PLUG
Controls:	
Control box:	not included
Moisture sensor:	with moisture sensors
Water-in-oil sensor:	with water-in-oil sensor
Temp. sensor:	Y
Others:	
Net weight:	94 kg
Country of origin:	HU
Custom tariff no.:	84137021

96177701 SEV.65.80.30.A.EX.2.50D 50 Hz

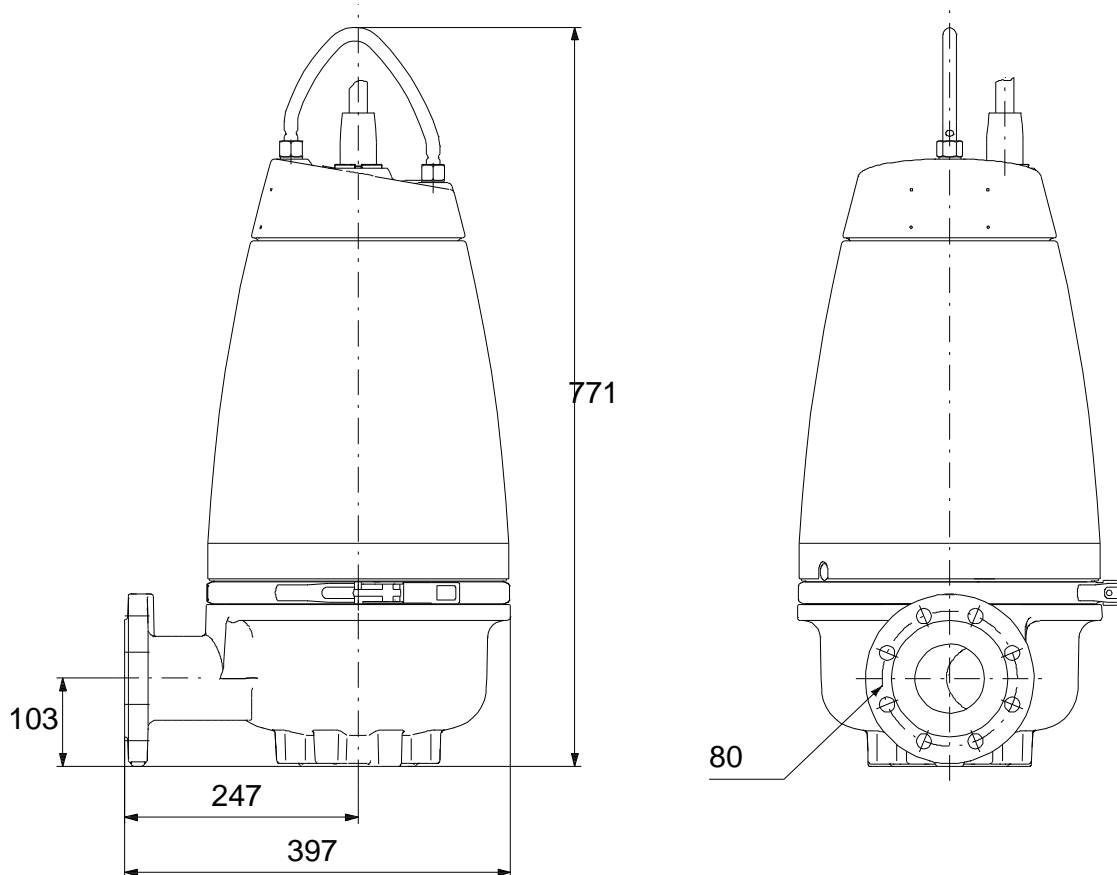
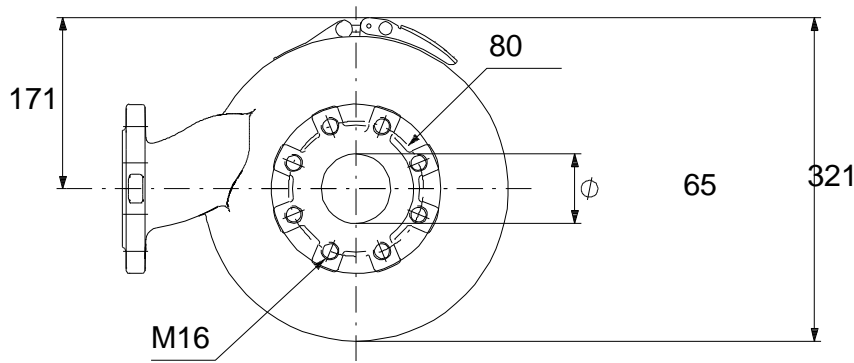

Note! All units are in [mm] unless others are stated.
Disclaimer: This simplified dimensional drawing does not show all details.

96177701 SEV.65.80.30.A.EX.2.50D 50 Hz

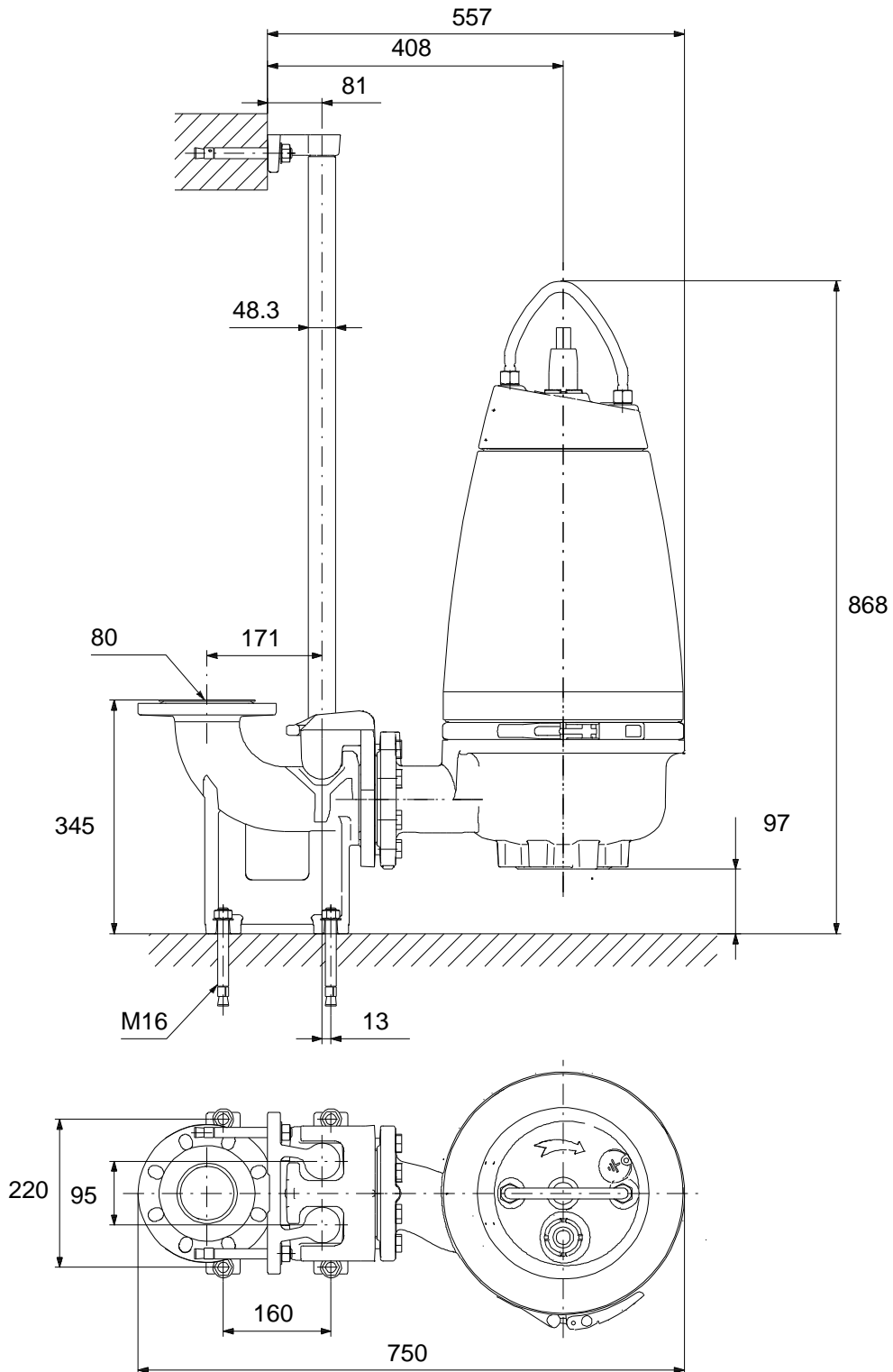

Note! All units are in [mm] unless others are stated.
 Disclaimer: This simplified dimensional drawing does not show all details.

96177701 SEV.65.80.30.A.EX.2.50D 50 Hz

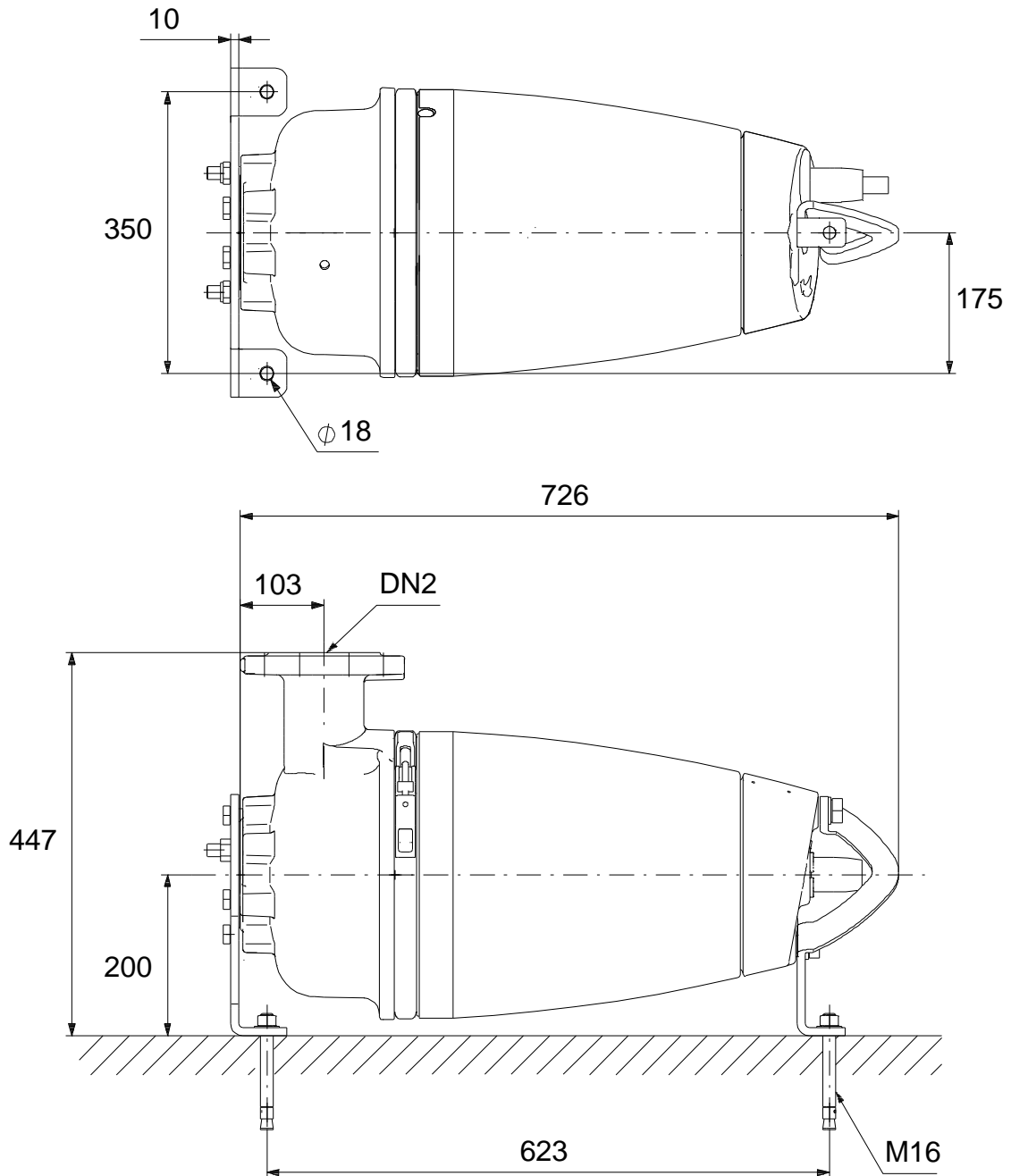

Note! All units are in [mm] unless others are stated.
Disclaimer: This simplified dimensional drawing does not show all details.

96177701 SEV.65.80.30.A.EX.2.50D 50 Hz

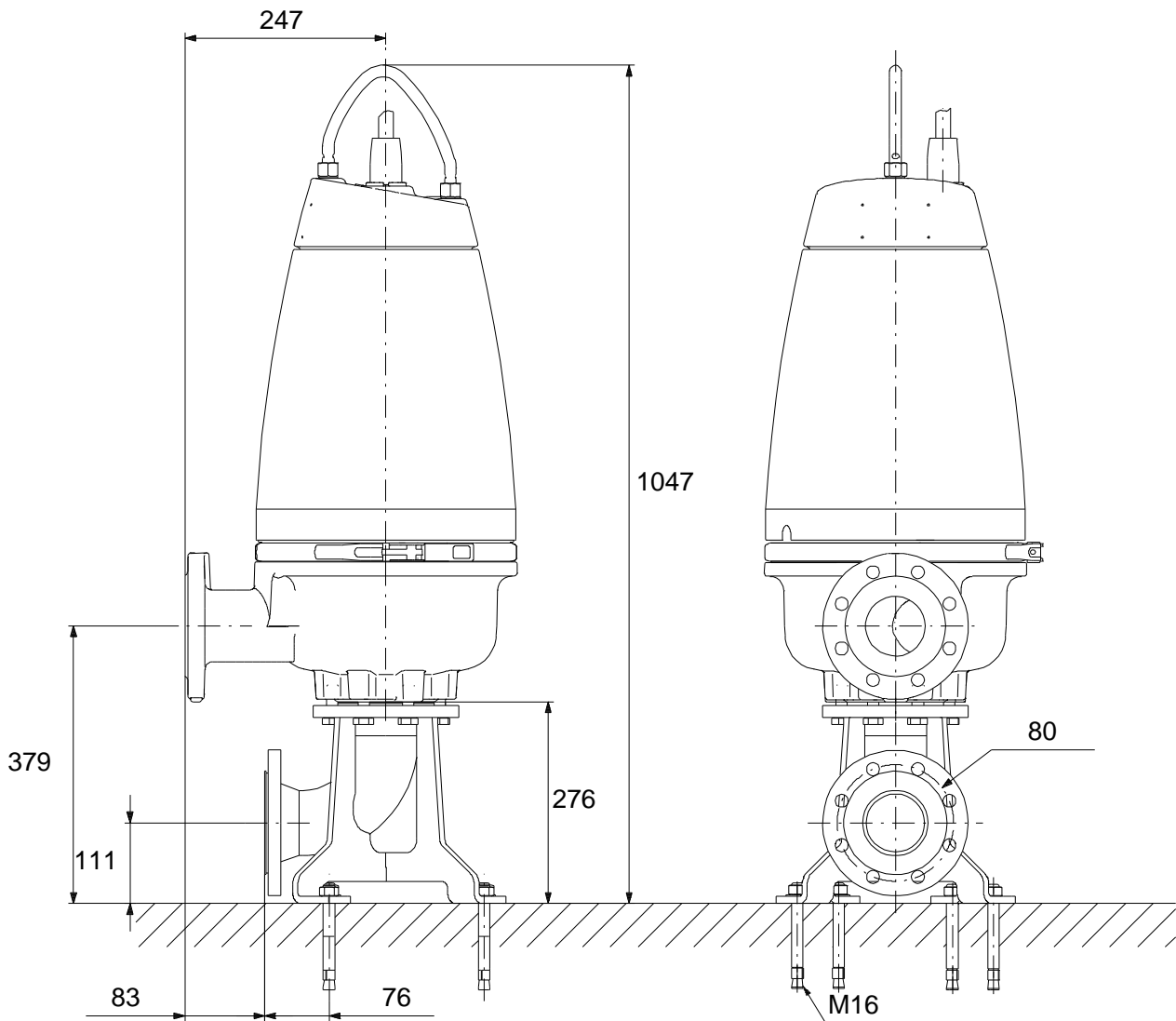
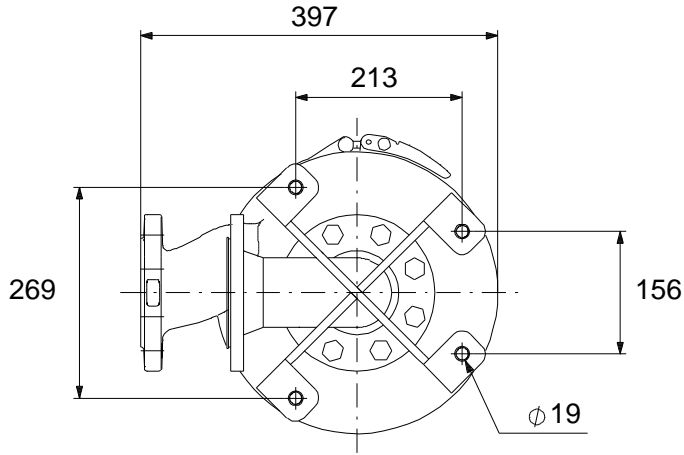

Note! All units are in [mm] unless others are stated.
Disclaimer: This simplified dimensional drawing does not show all details.

96177701 SEV.65.80.30.A.EX.2.50D 50 Hz

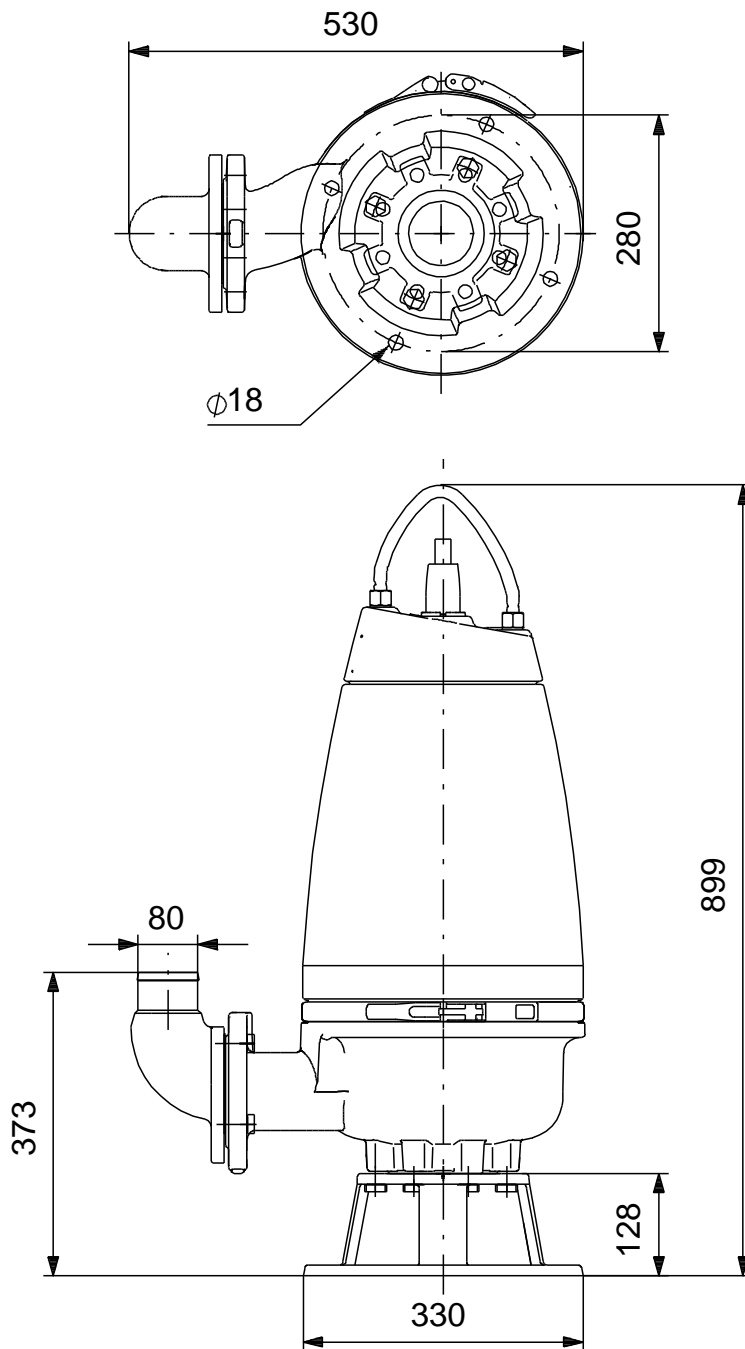

Note! All units are in [mm] unless others are stated.
Disclaimer: This simplified dimensional drawing does not show all details.