

Qty.	Description																																																		
1	<p data-bbox="199 340 502 369">SE1.100.150.40.A.4.51D.B</p> <div data-bbox="226 383 560 663">  </div> <p data-bbox="592 642 1075 667">Note! Product picture may differ from actual product</p> <p data-bbox="199 674 469 701">Product No.: 96177650</p> <p data-bbox="199 732 1460 786">Non-self-priming, single-stage, centrifugal pump designed for handling wastewater, process water and unscreened raw sewage.</p> <p data-bbox="199 792 1460 893">The pump is designed for intermittent and continuous operation. The liquidless and maintenance free cooling system ensures that the pump can be used for submerged or dry installation. The revolutionary S-tube® impeller provides free spherical passage of solids up to 100 mm and is suitable for wastewater with a dry matter content of up to 3 %.</p> <p data-bbox="199 904 1401 958">A unique stainless-steel clamp assembling system enables quick and easy disassembly of the pump from the motor unit for service and inspection. No special tools are required. Pipework connection is via a DIN flange.</p> <p data-bbox="199 1021 316 1048">Controls:</p> <table data-bbox="199 1052 821 1137"> <tr> <td>Moisture sensor:</td> <td>with moisture sensors</td> </tr> <tr> <td>Water-in-oil sensor:</td> <td>with water-in-oil sensor</td> </tr> <tr> <td>Temp. sensor:</td> <td>Y</td> </tr> </table> <p data-bbox="199 1171 288 1198">Liquid:</p> <table data-bbox="199 1202 799 1288"> <tr> <td>Pumped liquid:</td> <td>Any Newtonian liquid</td> </tr> <tr> <td>Liquid temperature range:</td> <td>0 .. 40 °C</td> </tr> <tr> <td>Density:</td> <td>998.2 kg/m³</td> </tr> </table> <p data-bbox="199 1321 327 1348">Technical:</p> <table data-bbox="199 1352 810 1556"> <tr> <td>Type of impeller:</td> <td>S-TUBE</td> </tr> <tr> <td>Maximum particle size:</td> <td>100 mm</td> </tr> <tr> <td>Primary shaft seal:</td> <td>SIC/SIC</td> </tr> <tr> <td>Secondary shaft seal:</td> <td>CARBON/CERAMICS</td> </tr> <tr> <td>Max. hydraulic efficiency:</td> <td>66 %</td> </tr> <tr> <td>Approvals on nameplate:</td> <td>EN12050-1</td> </tr> <tr> <td>Curve tolerance:</td> <td>ISO9906:2012 3B2</td> </tr> </table> <p data-bbox="199 1588 320 1615">Materials:</p> <table data-bbox="199 1619 810 1675"> <tr> <td>Pump housing:</td> <td>EN 1561 EN-GJL-250</td> </tr> <tr> <td>Impeller:</td> <td>Cast iron</td> </tr> </table> <p data-bbox="199 1709 343 1736">Installation:</p> <table data-bbox="199 1740 651 1883"> <tr> <td>Maximum operating pressure:</td> <td>6 bar</td> </tr> <tr> <td>Flange standard:</td> <td>DIN</td> </tr> <tr> <td>Pump outlet:</td> <td>DN 150</td> </tr> <tr> <td>Pressure rating:</td> <td>PN 10</td> </tr> <tr> <td>Maximum installation depth:</td> <td>20 m</td> </tr> </table> <p data-bbox="199 1917 379 1944">Electrical data:</p> <table data-bbox="199 1948 719 2092"> <tr> <td>Power input - P1:</td> <td>4.9 kW</td> </tr> <tr> <td>Rated power - P2:</td> <td>4 kW</td> </tr> <tr> <td>Mains frequency:</td> <td>50 Hz</td> </tr> <tr> <td>Rated voltage:</td> <td>3 x 380-415 V</td> </tr> <tr> <td>Voltage tolerance:</td> <td>+6/-10 %</td> </tr> </table>	Moisture sensor:	with moisture sensors	Water-in-oil sensor:	with water-in-oil sensor	Temp. sensor:	Y	Pumped liquid:	Any Newtonian liquid	Liquid temperature range:	0 .. 40 °C	Density:	998.2 kg/m ³	Type of impeller:	S-TUBE	Maximum particle size:	100 mm	Primary shaft seal:	SIC/SIC	Secondary shaft seal:	CARBON/CERAMICS	Max. hydraulic efficiency:	66 %	Approvals on nameplate:	EN12050-1	Curve tolerance:	ISO9906:2012 3B2	Pump housing:	EN 1561 EN-GJL-250	Impeller:	Cast iron	Maximum operating pressure:	6 bar	Flange standard:	DIN	Pump outlet:	DN 150	Pressure rating:	PN 10	Maximum installation depth:	20 m	Power input - P1:	4.9 kW	Rated power - P2:	4 kW	Mains frequency:	50 Hz	Rated voltage:	3 x 380-415 V	Voltage tolerance:	+6/-10 %
Moisture sensor:	with moisture sensors																																																		
Water-in-oil sensor:	with water-in-oil sensor																																																		
Temp. sensor:	Y																																																		
Pumped liquid:	Any Newtonian liquid																																																		
Liquid temperature range:	0 .. 40 °C																																																		
Density:	998.2 kg/m ³																																																		
Type of impeller:	S-TUBE																																																		
Maximum particle size:	100 mm																																																		
Primary shaft seal:	SIC/SIC																																																		
Secondary shaft seal:	CARBON/CERAMICS																																																		
Max. hydraulic efficiency:	66 %																																																		
Approvals on nameplate:	EN12050-1																																																		
Curve tolerance:	ISO9906:2012 3B2																																																		
Pump housing:	EN 1561 EN-GJL-250																																																		
Impeller:	Cast iron																																																		
Maximum operating pressure:	6 bar																																																		
Flange standard:	DIN																																																		
Pump outlet:	DN 150																																																		
Pressure rating:	PN 10																																																		
Maximum installation depth:	20 m																																																		
Power input - P1:	4.9 kW																																																		
Rated power - P2:	4 kW																																																		
Mains frequency:	50 Hz																																																		
Rated voltage:	3 x 380-415 V																																																		
Voltage tolerance:	+6/-10 %																																																		

Qty.	Description																																																										
	<table> <tr><td>Max starts per. hour:</td><td>20</td></tr> <tr><td>Rated current:</td><td>10.0-10.2 A</td></tr> <tr><td>Rated current at 3/4 load:</td><td>8.2 A</td></tr> <tr><td>Rated current at 1/2 load:</td><td>7.1 A</td></tr> <tr><td>Starting current:</td><td>67 A</td></tr> <tr><td>Rated current at no load:</td><td>6.1 A</td></tr> <tr><td>Cos phi - power factor:</td><td>0.73</td></tr> <tr><td>Cos phi - p.f. at no load:</td><td>0.11</td></tr> <tr><td>Cos phi - p.f. at 3/4 load:</td><td>0.65</td></tr> <tr><td>Cos phi - p.f. at 1/2 load:</td><td>0.52</td></tr> <tr><td>Rated speed:</td><td>1460 rpm</td></tr> <tr><td>Locked-rotor torque:</td><td>72 Nm</td></tr> <tr><td>Breakdown torque:</td><td>100 Nm</td></tr> <tr><td>Moment of inertia:</td><td>0.128 kg m²</td></tr> <tr><td>Motor efficiency at full load:</td><td>82.2 %</td></tr> <tr><td>Motor efficiency at 3/4 load:</td><td>81.7 %</td></tr> <tr><td>Motor efficiency at 1/2 load:</td><td>78.2 %</td></tr> <tr><td>Number of poles:</td><td>4</td></tr> <tr><td>Start. method:</td><td>star/delta</td></tr> <tr><td>Enclosure class (IEC 34-5):</td><td>IP68</td></tr> <tr><td>Insulation class (IEC 85):</td><td>F</td></tr> <tr><td>Explosion proof:</td><td>no</td></tr> <tr><td>Length of cable:</td><td>10 m</td></tr> <tr><td>Cable type:</td><td>LYNIFLEX</td></tr> <tr><td>Type of cable plug:</td><td>NO PLUG</td></tr> <tr><td colspan="2">Others:</td></tr> <tr><td>Net weight:</td><td>166 kg</td></tr> <tr><td>Country of origin:</td><td>HU</td></tr> <tr><td>Custom tariff no.:</td><td>84137021</td></tr> </table>	Max starts per. hour:	20	Rated current:	10.0-10.2 A	Rated current at 3/4 load:	8.2 A	Rated current at 1/2 load:	7.1 A	Starting current:	67 A	Rated current at no load:	6.1 A	Cos phi - power factor:	0.73	Cos phi - p.f. at no load:	0.11	Cos phi - p.f. at 3/4 load:	0.65	Cos phi - p.f. at 1/2 load:	0.52	Rated speed:	1460 rpm	Locked-rotor torque:	72 Nm	Breakdown torque:	100 Nm	Moment of inertia:	0.128 kg m ²	Motor efficiency at full load:	82.2 %	Motor efficiency at 3/4 load:	81.7 %	Motor efficiency at 1/2 load:	78.2 %	Number of poles:	4	Start. method:	star/delta	Enclosure class (IEC 34-5):	IP68	Insulation class (IEC 85):	F	Explosion proof:	no	Length of cable:	10 m	Cable type:	LYNIFLEX	Type of cable plug:	NO PLUG	Others:		Net weight:	166 kg	Country of origin:	HU	Custom tariff no.:	84137021
Max starts per. hour:	20																																																										
Rated current:	10.0-10.2 A																																																										
Rated current at 3/4 load:	8.2 A																																																										
Rated current at 1/2 load:	7.1 A																																																										
Starting current:	67 A																																																										
Rated current at no load:	6.1 A																																																										
Cos phi - power factor:	0.73																																																										
Cos phi - p.f. at no load:	0.11																																																										
Cos phi - p.f. at 3/4 load:	0.65																																																										
Cos phi - p.f. at 1/2 load:	0.52																																																										
Rated speed:	1460 rpm																																																										
Locked-rotor torque:	72 Nm																																																										
Breakdown torque:	100 Nm																																																										
Moment of inertia:	0.128 kg m ²																																																										
Motor efficiency at full load:	82.2 %																																																										
Motor efficiency at 3/4 load:	81.7 %																																																										
Motor efficiency at 1/2 load:	78.2 %																																																										
Number of poles:	4																																																										
Start. method:	star/delta																																																										
Enclosure class (IEC 34-5):	IP68																																																										
Insulation class (IEC 85):	F																																																										
Explosion proof:	no																																																										
Length of cable:	10 m																																																										
Cable type:	LYNIFLEX																																																										
Type of cable plug:	NO PLUG																																																										
Others:																																																											
Net weight:	166 kg																																																										
Country of origin:	HU																																																										
Custom tariff no.:	84137021																																																										

96177650 SE1.100.150.40.A.4.51D.B 50 Hz

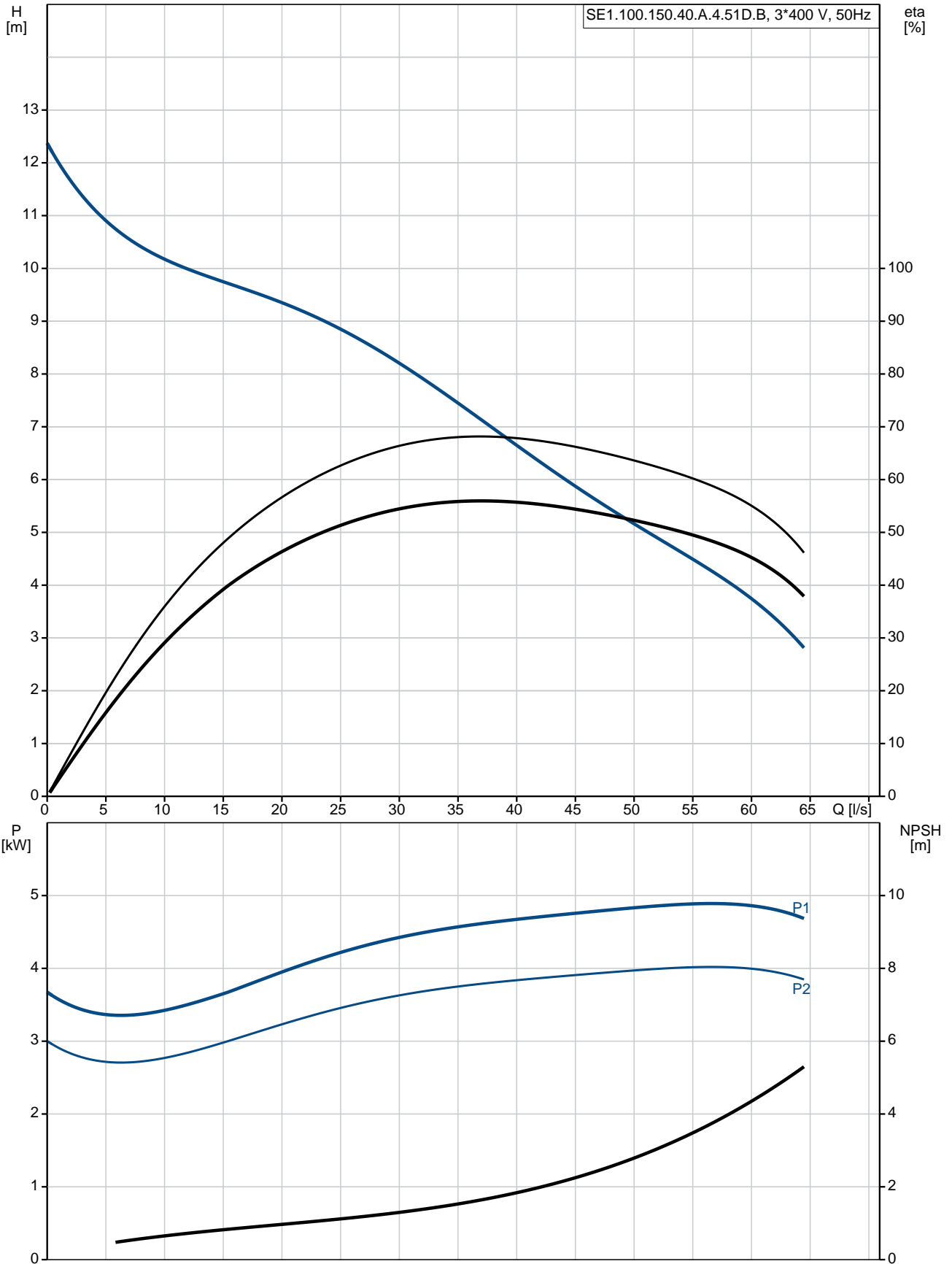

Description	Value
General information:	
Product name:	SE1.100.150.40.A.4.51D.B
Product No:	96177650
EAN number:	5700830442210
	5700830442210
Price:	5.333,00 GBP
Technical:	
Max flow:	64.4 l/s
Head max:	11.2 m
Type of impeller:	S-TUBE
Maximum particle size:	100 mm
Primary shaft seal:	SIC/SIC
Secondary shaft seal:	CARBON/CERAMICS
Max. hydraulic efficiency:	66 %
Approvals on nameplate:	EN12050-1
Curve tolerance:	ISO9906:2012 3B2
Cooling jacket:	with cooling jacket
Materials:	
Pump housing:	EN 1561 EN-GJL-250
Impeller:	Cast iron
Installation:	
Maximum operating pressure:	6 bar
Flange standard:	DIN
Pump outlet:	DN 150
Pressure rating:	PN 10
Maximum installation depth:	20 m
Inst dry/wet:	DRY/SUBMERGED
Installation:	horizontal or vertical
Liquid:	
Pumped liquid:	Any Newtonian liquid
Liquid temperature range:	0 .. 40 °C
Density:	998.2 kg/m ³
Electrical data:	
Power input - P1:	4.9 kW
Rated power - P2:	4 kW
Mains frequency:	50 Hz
Rated voltage:	3 x 380-415 V
Voltage tolerance:	+6/-10 %
Max starts per. hour:	20
Rated current:	10.0-10.2 A
Rated current at 3/4 load:	8.2 A
Rated current at 1/2 load:	7.1 A
Starting current:	67 A
Rated current at no load:	6.1 A
Cos phi - power factor:	0.73
Cos phi - p.f. at no load:	0.11
Cos phi - p.f. at 3/4 load:	0.65
Cos phi - p.f. at 1/2 load:	0.52
Rated speed:	1460 rpm
Locked-rotor torque:	72 Nm
Breakdown torque:	100 Nm
Moment of inertia:	0.128 kg m ²
Motor efficiency at full load:	82.2 %
Motor efficiency at 3/4 load:	81.7 %
Motor efficiency at 1/2 load:	78.2 %
Number of poles:	4
Start. method:	star/delta
Enclosure class (IEC 34-5):	IP68

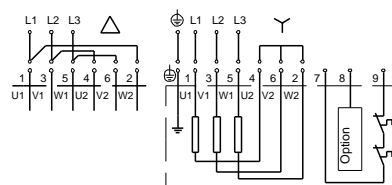
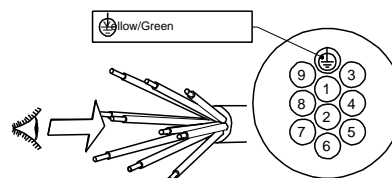
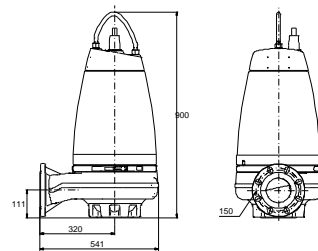
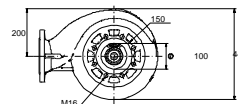
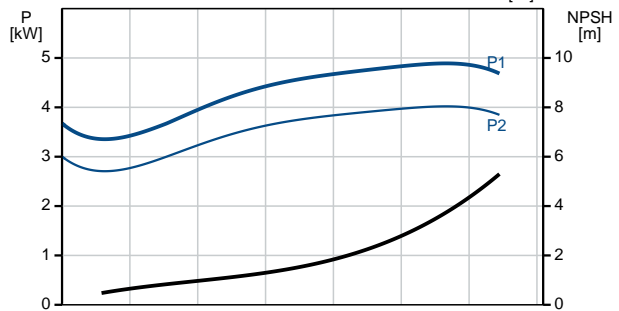
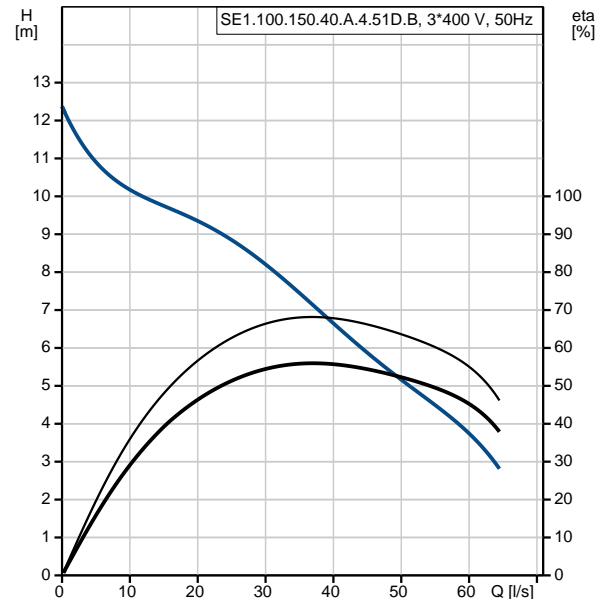



Company name:

Created by:

Phone:

Date:

23/01/2020

Description	Value
Insulation class (IEC 85):	F
Explosion proof:	no
Motor protec:	THERMAL SWITCH
Thermal protec:	internal
Length of cable:	10 m
Cable type:	LYNIFLEX
Type of cable plug:	NO PLUG
Controls:	
Control box:	not included
Moisture sensor:	with moisture sensors
Water-in-oil sensor:	with water-in-oil sensor
Temp. sensor:	Y
Others:	
Net weight:	166 kg
Country of origin:	HU
Custom tariff no.:	84137021

96177650 SE1.100.150.40.A.4.51D.B 50 Hz

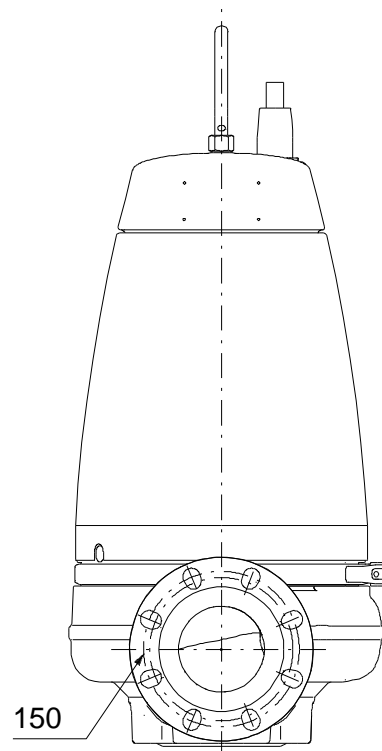
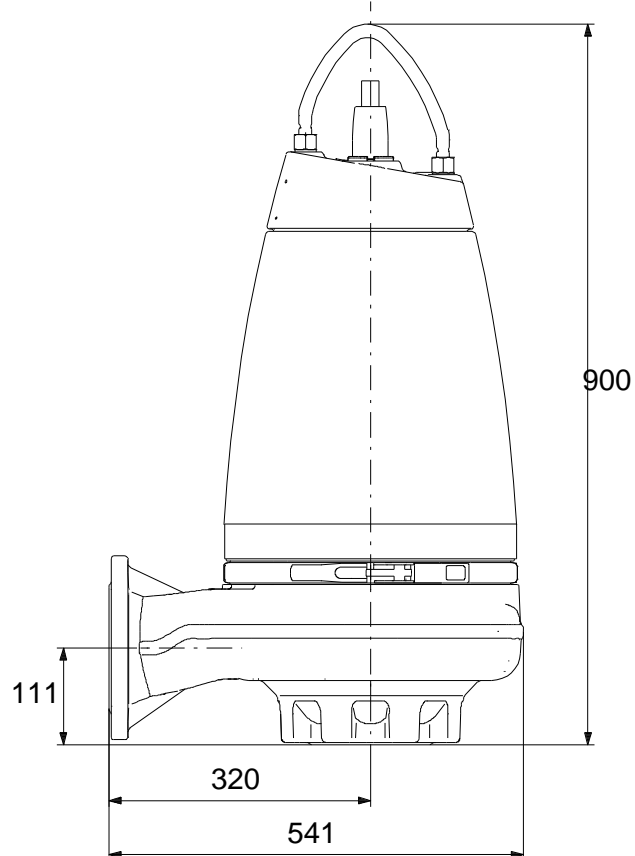
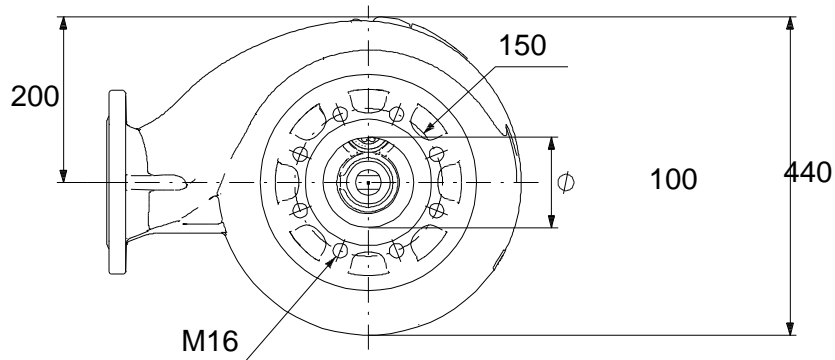

Note! All units are in [mm] unless others are stated.
Disclaimer: This simplified dimensional drawing does not show all details.

96177650 SE1.100.150.40.A.4.51D.B 50 Hz

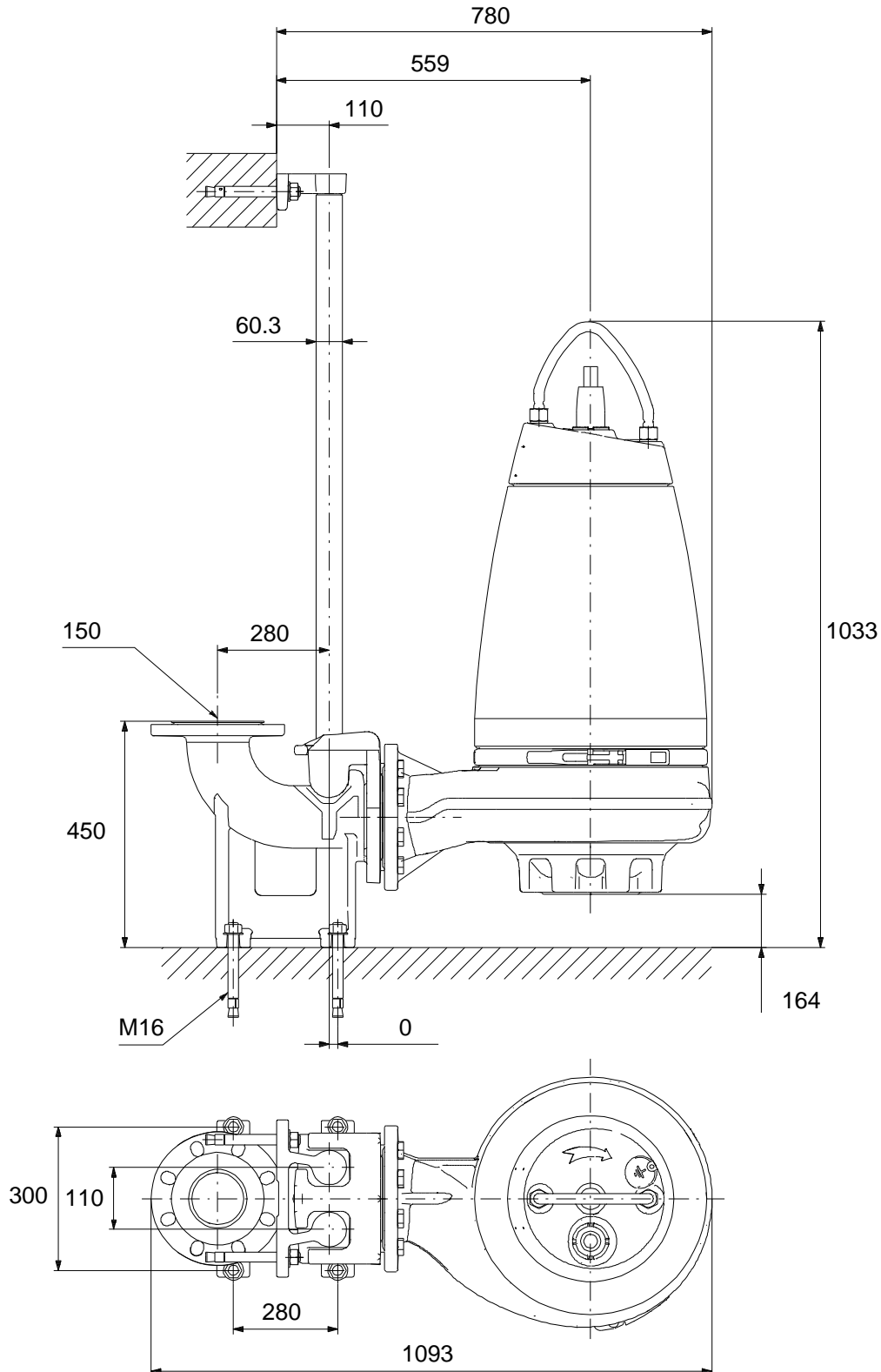

Note! All units are in [mm] unless others are stated.
Disclaimer: This simplified dimensional drawing does not show all details.

96177650 SE1.100.150.40.A.4.51D.B 50 Hz

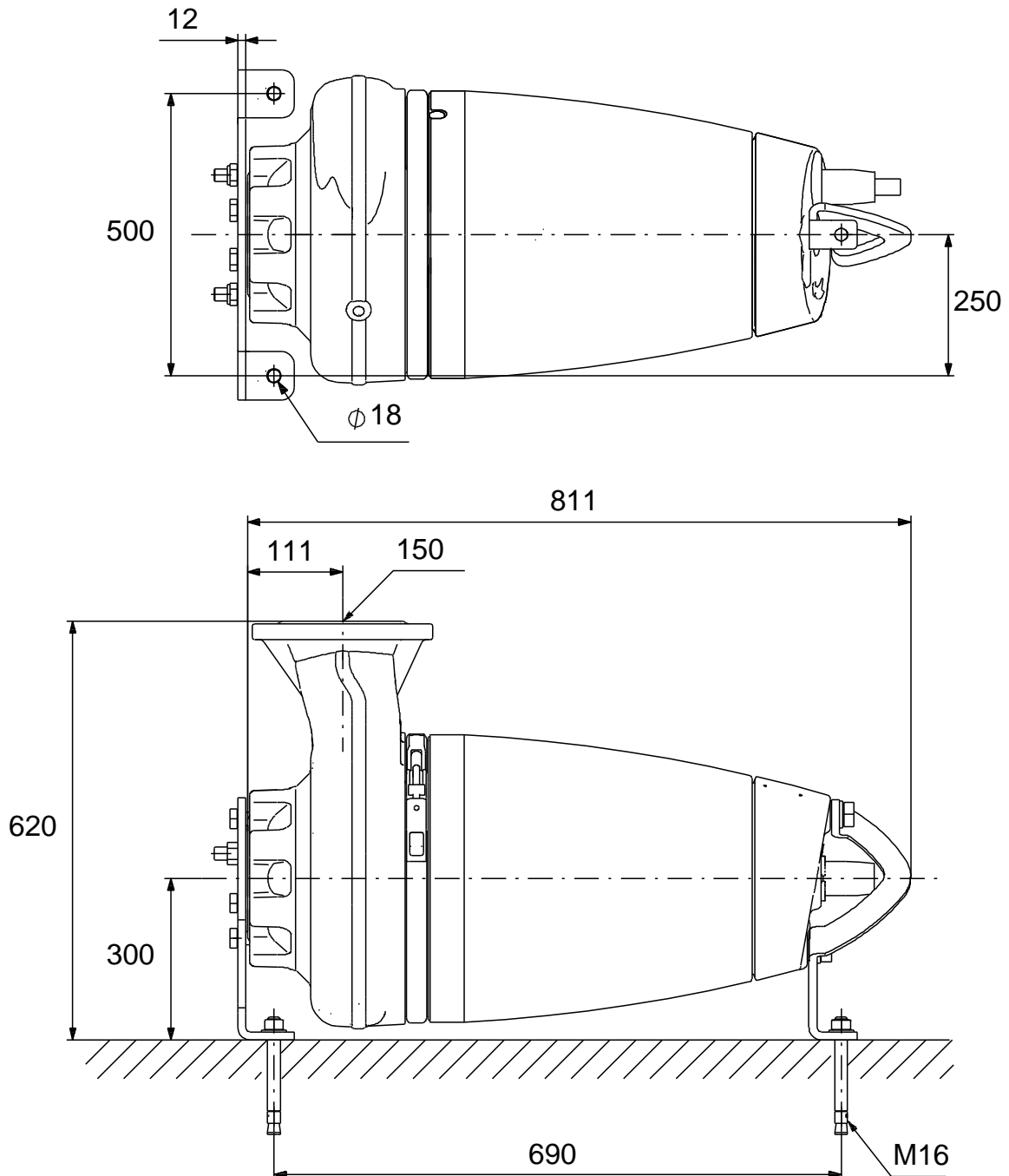

Note! All units are in [mm] unless others are stated.
Disclaimer: This simplified dimensional drawing does not show all details.

96177650 SE1.100.150.40.A.4.51D.B 50 Hz

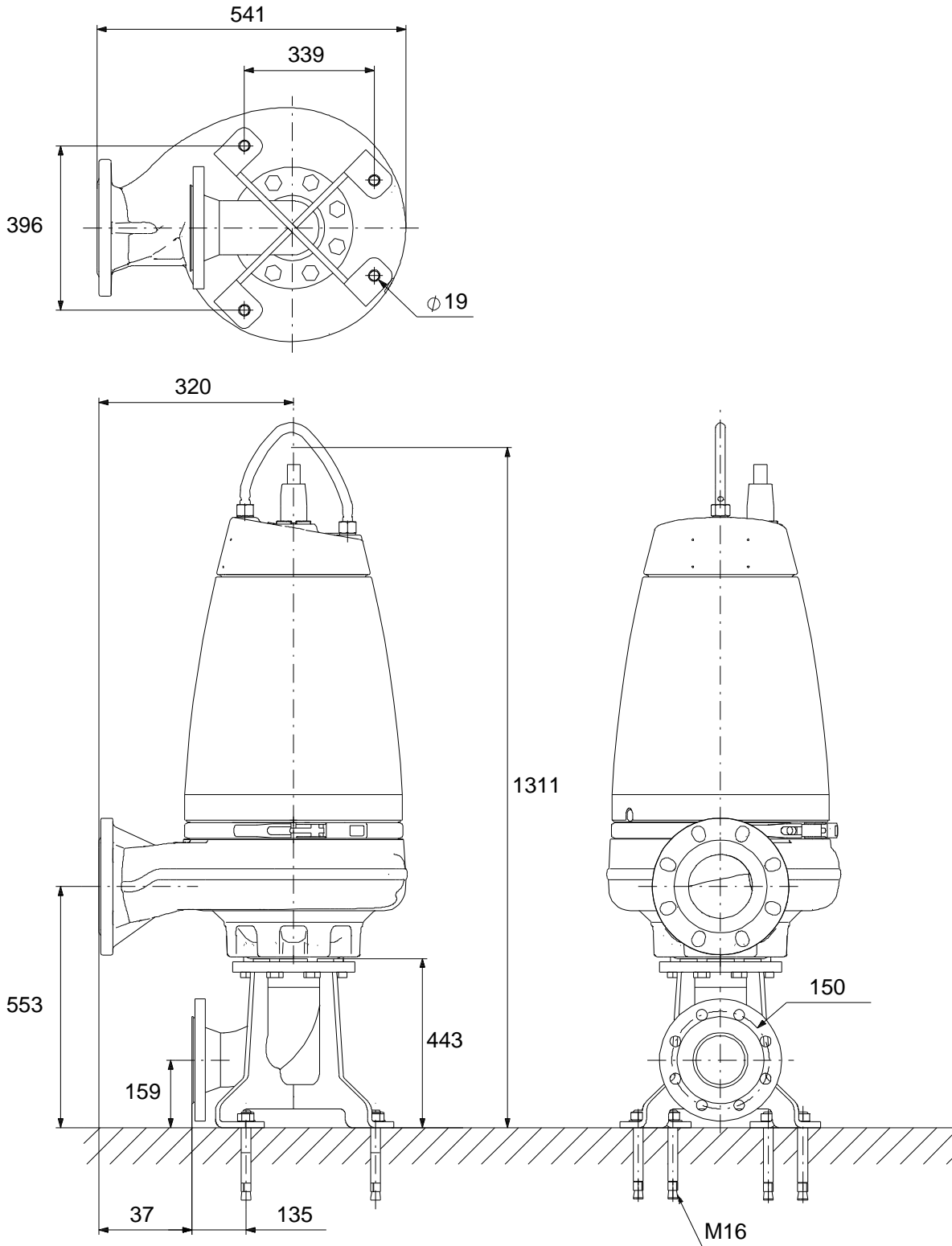

Note! All units are in [mm] unless others are stated.
Disclaimer: This simplified dimensional drawing does not show all details.

96177650 SE1.100.150.40.A.4.51D.B 50 Hz

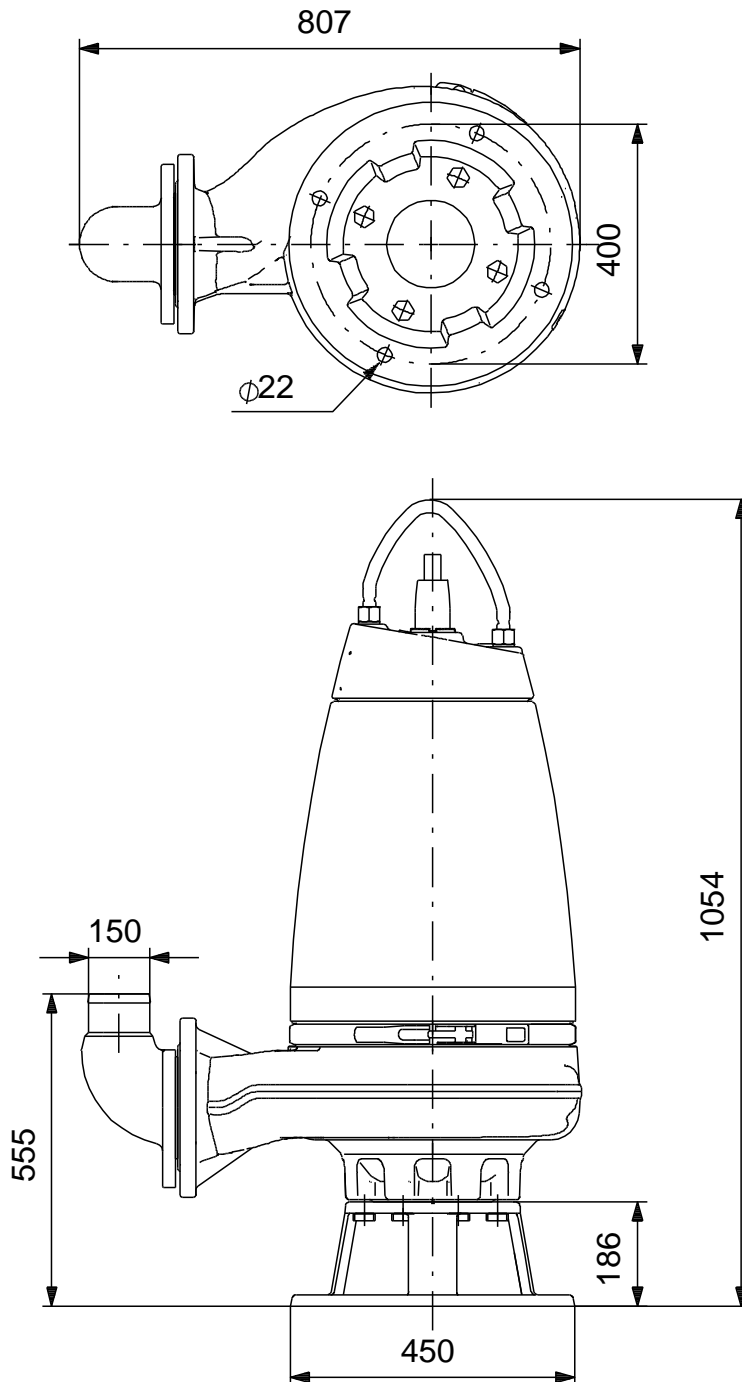

Note! All units are in [mm] unless others are stated.
Disclaimer: This simplified dimensional drawing does not show all details.