

Position	Qty.	Description
	1	<p>CR 64-7-2 A-F-A-V-HQQV</p>  <p>Product No.: 96123565</p> <p>Vertical, multistage centrifugal pump with suction and discharge ports on same the level (in-line) enabling installation in a horizontal one-pipe system. The pump head and base are in cast iron – all other wetted parts are in stainless steel. A cartridge shaft seal ensures high reliability, safe handling and easy service and access. Power transmission is via a rigid split coupling. Pipework connection is via DIN flanges.</p> <p>The pump is fitted with a 3-phase, fan-cooled asynchronous motor.</p> <p>Liquid: Pumped liquid: Water Liquid temperature range: -20 .. 90 °C Liquid temperature during operation: 20 °C Density: 998.2 kg/m³</p> <p>Technical: Rated flow: 64 m³/h Rated head: 147.5 m Pump orientation: Vertical Shaft seal arrangement: Single Code for shaft seal: HQQV Approvals on nameplate: CE, EAC Curve tolerance: ISO9906:2012 3B</p> <p>Materials: Base: Cast iron EN 1563 EN-GJS-500-7 ASTM A536 80-55-06 Impeller: Stainless steel EN 1.4301 AISI 304 Bearing: SIC Support bearing: Graflon</p> <p>Installation: Maximum ambient temperature: 55 °C Maximum operating pressure: 30 bar Max pressure at stated temp: 30 bar / 90 °C 30 bar / -20 °C Type of connection: DIN Size of inlet connection: DN 100 Size of outlet connection: DN 100 Pressure rating for pipe connection: PN 40 Flange size for motor: FF350</p> <p>Electrical data: Motor standard: IEC</p>

Position	Qty.	Description
		<p>Motor type: SIEMENS</p> <p>IE Efficiency class: IE3</p> <p>Rated power - P2: 37 kW</p> <p>Power (P2) required by pump: 37 kW</p> <p>Mains frequency: 50 Hz</p> <p>Rated voltage: 3 x 380-420D/660-725Y V</p> <p>Rated current: 68,0-63,0/39,0-36,0 A</p> <p>Starting current: 670-670 %</p> <p>Cos phi - power factor: 0.87</p> <p>Rated speed: 2955 rpm</p> <p>Efficiency: IE3 93,7%</p> <p>Motor efficiency at full load: 93.7-93.7 %</p> <p>Motor efficiency at 3/4 load: 93.9-93.9 %</p> <p>Motor efficiency at 1/2 load: 93.5-93.5 %</p> <p>Number of poles: 2</p> <p>Enclosure class (IEC 34-5): 55 Dust/Jetting</p> <p>Insulation class (IEC 85): F</p> <p>Controls:</p> <p>Frequency converter: NONE</p> <p>Others:</p> <p>Minimum efficiency index, MEI : 0.7</p> <p>Net weight: 369 kg</p> <p>Gross weight: 413 kg</p> <p>Shipping volume: 0.808 m³</p> <p>Country of origin: GB</p> <p>Custom tariff no.: 84137075</p>

96123565 CR 64-7-2 A-F-A-V-HQQV 50 Hz

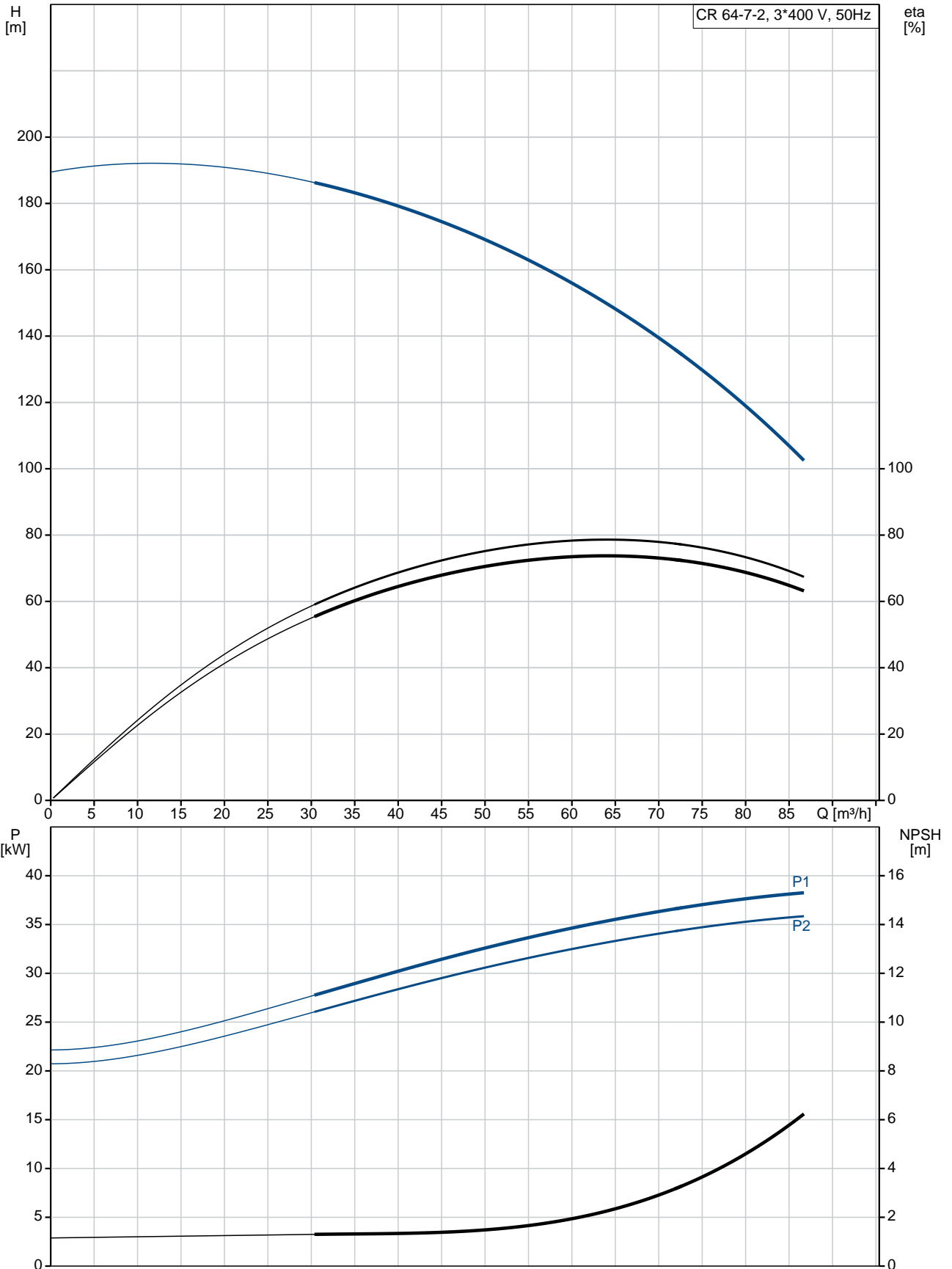

Description	Value
General information:	
Product name:	CR 64-7-2 A-F-A-V-HQQV
Product No:	96123565
EAN number:	5700396697758
Price:	9.359,00 GBP
Technical:	
Rated flow:	64 m ³ /h
Rated head:	147.5 m
Stages:	7
Impellers:	7
Number of reduced-diameter impellers:	2
Low NPSH:	N
Pump orientation:	Vertical
Shaft seal arrangement:	Single
Code for shaft seal:	HQQV
Approvals on nameplate:	CE, EAC
Curve tolerance:	ISO9906:2012 3B
Pump version:	A
Model:	B
Materials:	
Base:	Cast iron EN 1563 EN-GJS-500-7 ASTM A536 80-55-06
Impeller:	Stainless steel EN 1.4301 AISI 304
Material code:	A
Code for rubber:	V
Bearing:	SIC
Support bearing:	Graflon
Installation:	
Maximum ambient temperature:	55 °C
Maximum operating pressure:	30 bar
Max pressure at stated temp:	30 bar / 90 °C 30 bar / -20 °C
Type of connection:	DIN
Size of inlet connection:	DN 100
Size of outlet connection:	DN 100
Pressure rating for pipe connection:	PN 40
Flange size for motor:	FF350
Connect code:	F
Liquid:	
Pumped liquid:	Water
Liquid temperature range:	-20 .. 90 °C
Liquid temperature during operation:	20 °C
Density:	998.2 kg/m ³
Electrical data:	
Motor standard:	IEC
Motor type:	SIEMENS
IE Efficiency class:	IE3
Rated power - P2:	37 kW
Power (P2) required by pump:	37 kW
Mains frequency:	50 Hz
Rated voltage:	3 x 380-420D/660-725Y V
Rated current:	68,0-63,0/39,0-36,0 A
Starting current:	670-670 %
Cos phi - power factor:	0.87

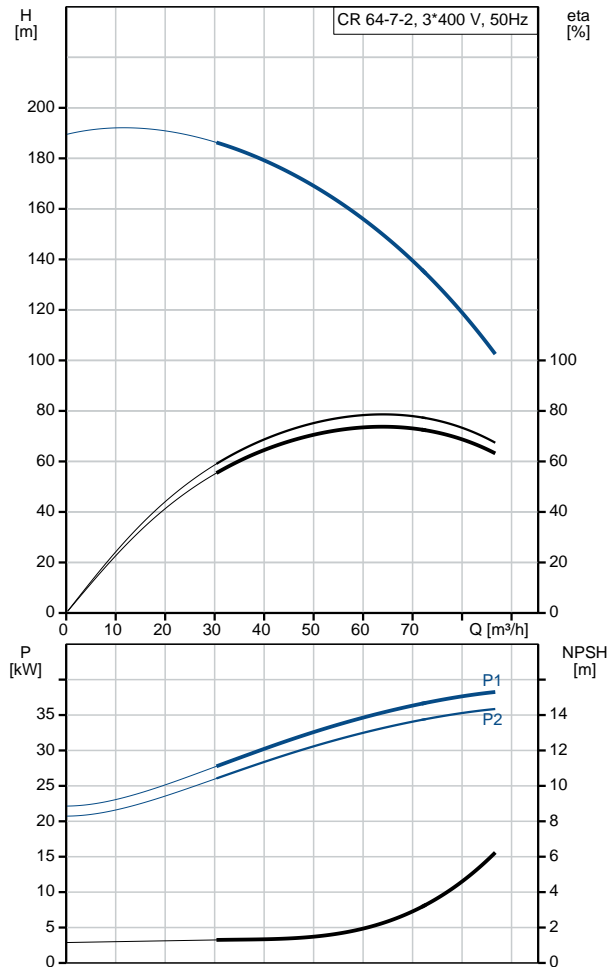



Company name:

Created by:

Phone:

Date:

12/09/2018

Description	Value
Rated speed:	2955 rpm
Efficiency:	IE3 93,7%
Motor efficiency at full load:	93.7-93.7 %
Motor efficiency at 3/4 load:	93.9-93.9 %
Motor efficiency at 1/2 load:	93.5-93.5 %
Number of poles:	2
Enclosure class (IEC 34-5):	55 Dust/Jetting
Insulation class (IEC 85):	F
Motor protec:	PTC
Motor No:	81U15334
Controls:	
Frequency converter:	NONE
Others:	
Minimum efficiency index, MEI :	0.7
Net weight:	369 kg
Gross weight:	413 kg
Shipping volume:	0.808 m ³
Country of origin:	GB
Custom tariff no.:	84137075

96123565 CR 64-7-2 A-F-A-V-HQQV 50 Hz

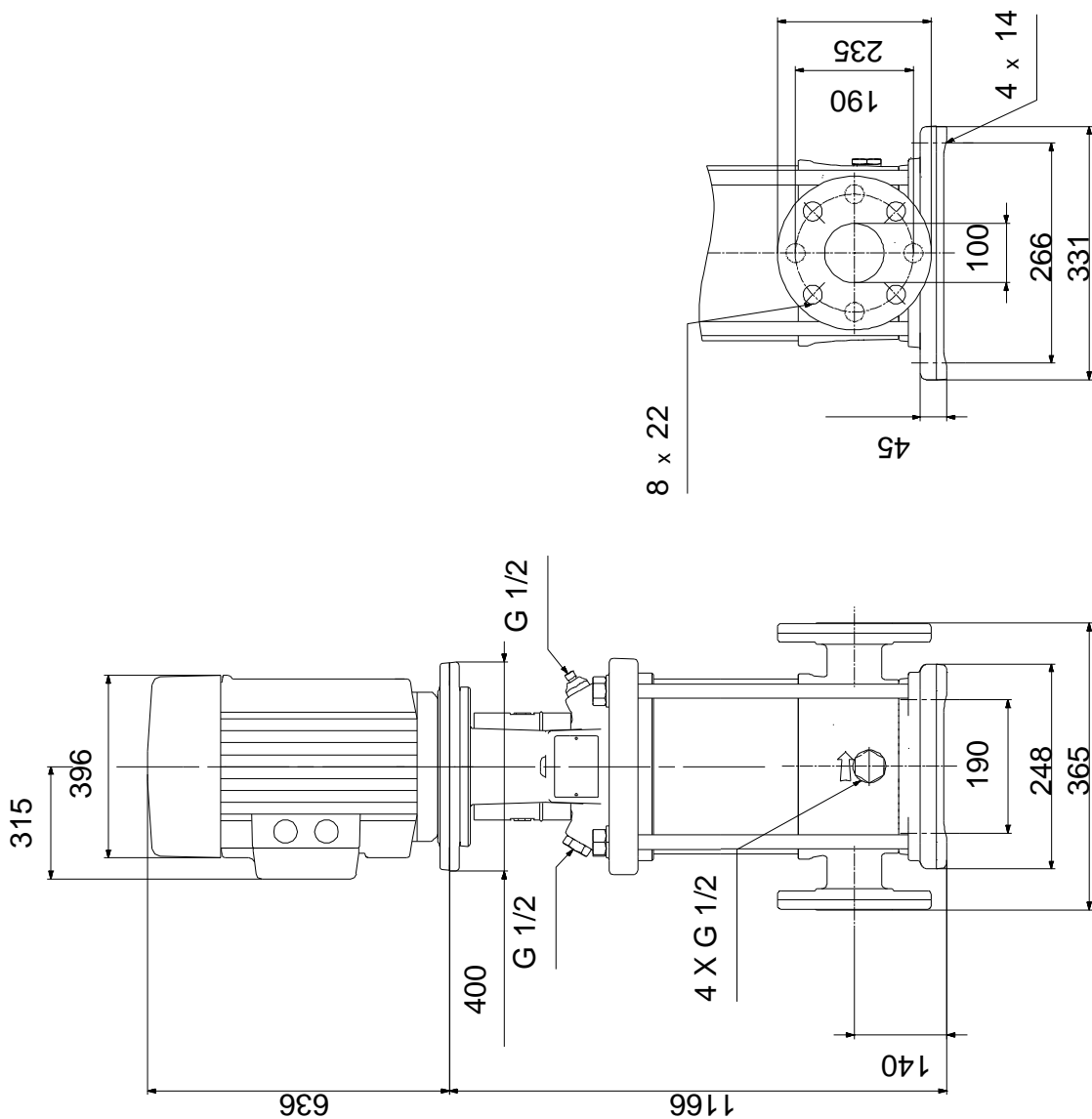

Note! All units are in [mm] unless others are stated.
Disclaimer: This simplified dimensional drawing does not show all details.

96123565 CR 64-7-2 A-F-A-V-HQQV 50 Hz

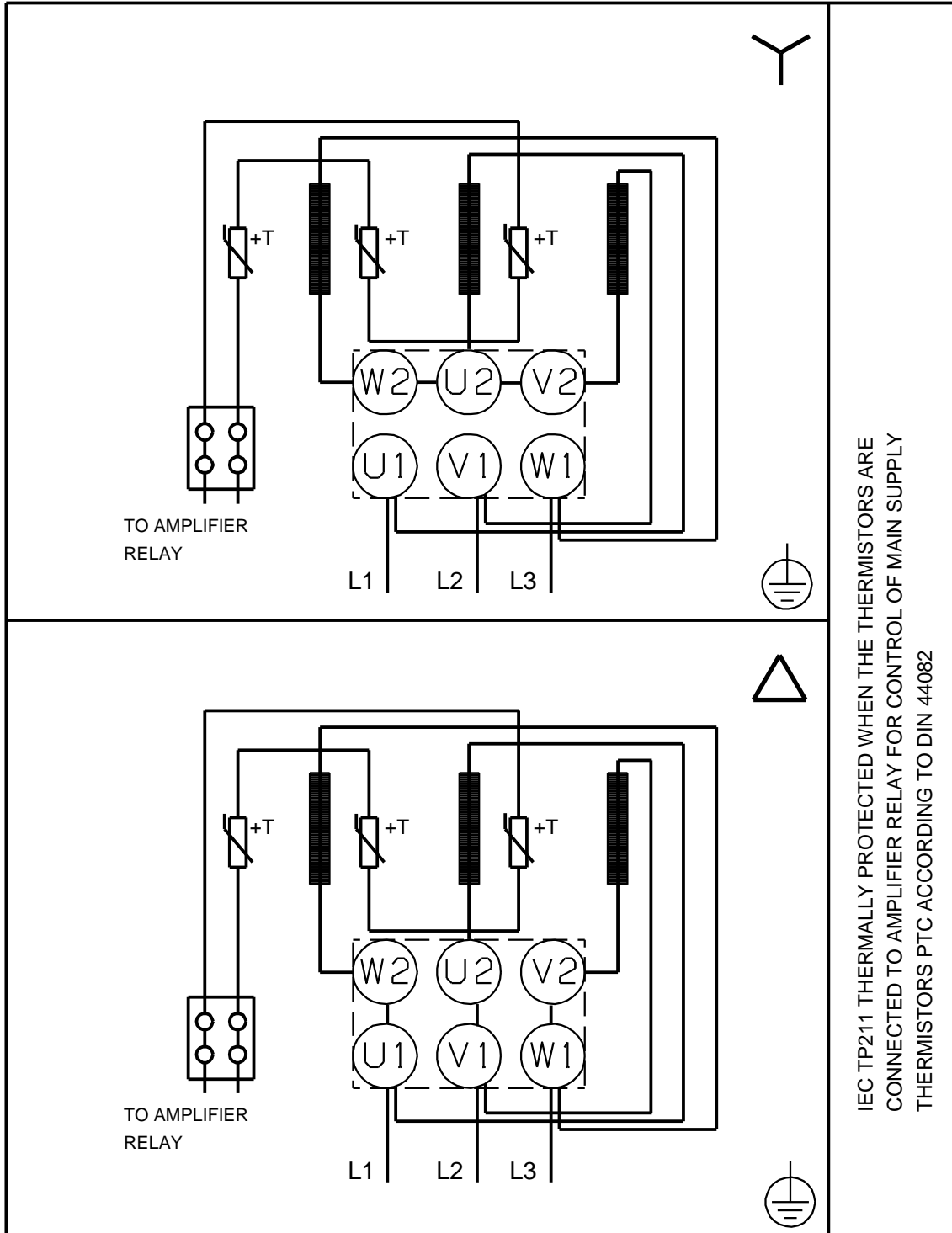

IEC TP211 THERMALLY PROTECTED WHEN THE THERMISTORS ARE
CONNECTED TO AMPLIFIER RELAY FOR CONTROL OF MAIN SUPPLY
THERMISTORS PTC ACCORDING TO DIN 44082

Note! All units are in [mm] unless others are stated.