

Position	Qty.	Description
	1	<p>TP 100-410/4 A-F-A-BQQE</p>  <p>Product No.: 96109311</p> <p>Single-stage, close-coupled, volute pump with in-line suction and discharge ports of identical diameter. The pump is of the top-pull-out design, i.e. the power head (motor, pump head and impeller) can be removed for maintenance or service while the pump housing remains in the pipework.</p> <p>The pump is fitted with an unbalanced rubber bellows seal. The shaft seal is according to EN 12756. Pipework connection is via PN 16 DIN flanges (EN 1092-2 and ISO 7005-2).</p> <p>The pump is fitted with a fan-cooled asynchronous motor.</p> <p>Liquid: Pumped liquid: Water Liquid temperature range: -25 .. 120 °C Liquid temperature during operation: 20 °C Density: 998.2 kg/m³</p> <p>Technical: Speed for pump data: 1465 rpm Rated flow: 171 m³/h Rated head: 32.7 m Actual impeller diameter: 334 mm Primary shaft seal: BQQE Curve tolerance: ISO9906:2012 3B</p> <p>Materials: Pump housing: Cast iron EN-JL1040 ASTM A48-40 B Impeller: Cast iron EN-JL1030 ASTM A48-30 B</p> <p>Installation: Range of ambient temperature: -20 .. 55 °C Maximum operating pressure: 16 bar Flange standard: DIN Pipe connection: DN 100 Pump inlet: DN 100 Pump outlet: DN 100 Pressure stage: PN 16 Port-to-port length: 670 mm Flange size for motor: FF300</p> <p>Electrical data: Motor type: SIEMENS IE Efficiency class: IE3 Rated power - P2: 22 kW Power (P2) required by pump: 22 kW Mains frequency: 50 Hz</p>

Position	Qty.	Description
		<p>Rated voltage: 3 x 380-420D/660-725Y V</p> <p>Rated current: 42,5-40,5/24,6-23,6 A</p> <p>Starting current: 680-680 %</p> <p>Cos phi - power factor: 0,83</p> <p>Rated speed: 1470 rpm</p> <p>Efficiency: IE3 93,0%</p> <p>Motor efficiency at full load: 93.0-93.0 %</p> <p>Motor efficiency at 3/4 load: 93.7-93.7 %</p> <p>Motor efficiency at 1/2 load: 93.7-93.7 %</p> <p>Number of poles: 4</p> <p>Enclosure class (IEC 34-5): 55 Dust/Jetting</p> <p>Insulation class (IEC 85): F</p> <p>Others:</p> <p>Minimum efficiency index, MEI : 0.69</p> <p>ErP status: EuP Standalone/Prod.</p> <p>Net weight: 351 kg</p> <p>Gross weight: 399 kg</p> <p>Shipping volume: 1.12 m³</p> <p>Danish: VVS NO 38 1716.410</p>

96109311 TP 100-410/4 50 Hz

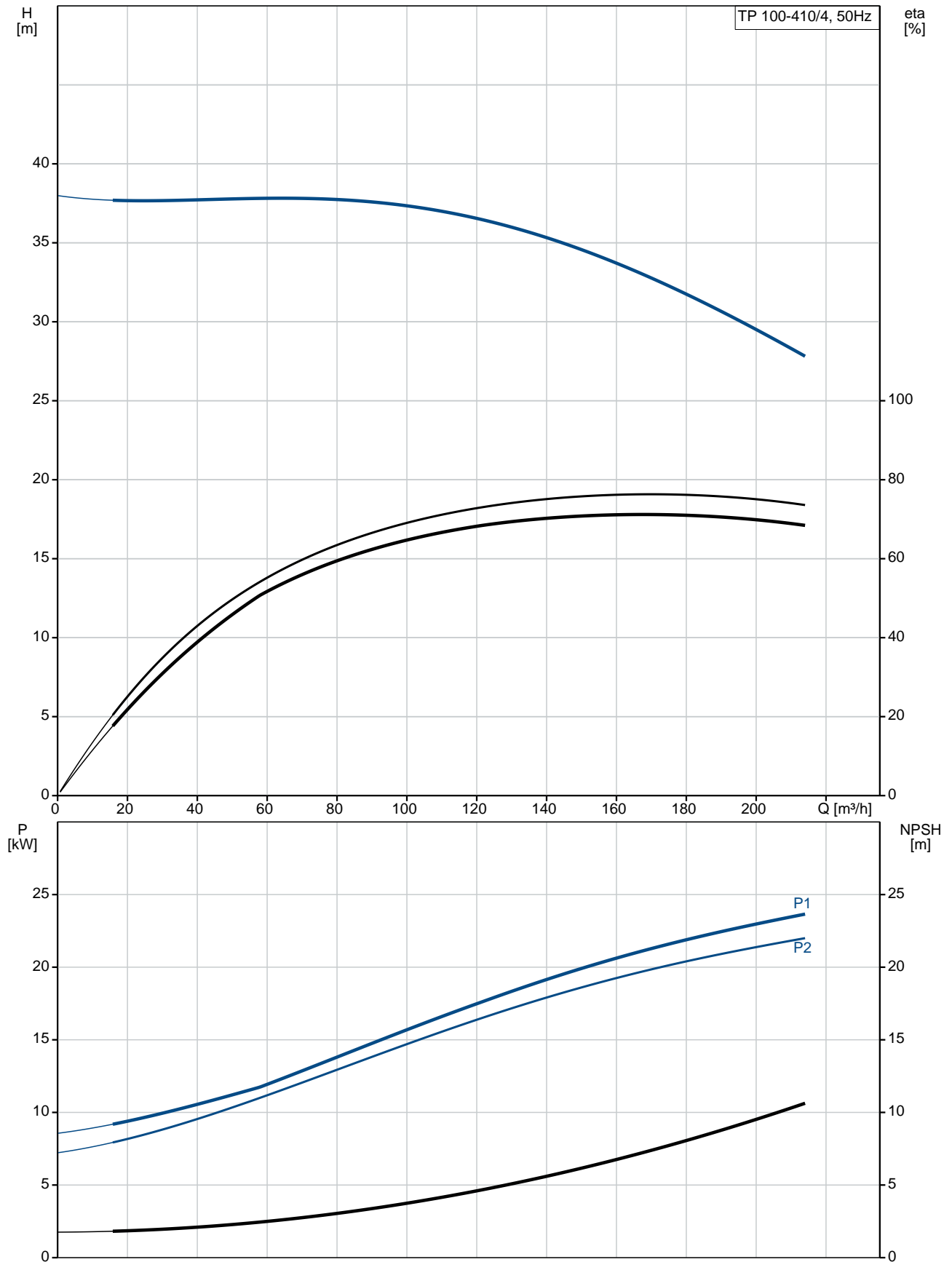

Description	Value
General information:	
Product name:	TP 100-410/4 A-F-A-BQQE
Product No:	96109311
EAN number:	5700396982885
Technical:	
Speed for pump data:	1465 rpm
Rated flow:	171 m ³ /h
Rated head:	32.7 m
Head max:	410 dm
Actual impeller diameter:	334 mm
Primary shaft seal:	BQQE
Curve tolerance:	ISO9906:2012 3B
Pump version:	A
Model:	A
Materials:	
Pump housing:	Cast iron EN-JL1040 ASTM A48-40 B
Impeller:	Cast iron EN-JL1030 ASTM A48-30 B
Material code:	A
Installation:	
Range of ambient temperature:	-20 .. 55 °C
Maximum operating pressure:	16 bar
Flange standard:	DIN
Connect code:	F
Pipe connection:	DN 100
Pump inlet:	DN 100
Pump outlet:	DN 100
Pressure stage:	PN 16
Port-to-port length:	670 mm
Flange size for motor:	FF300
Liquid:	
Pumped liquid:	Water
Liquid temperature range:	-25 .. 120 °C
Liquid temperature during operation:	20 °C
Density:	998.2 kg/m ³
Electrical data:	
Motor type:	SIEMENS
IE Efficiency class:	IE3
Rated power - P2:	22 kW
Power (P2) required by pump:	22 kW
Mains frequency:	50 Hz
Rated voltage:	3 x 380-420D/660-725Y V
Rated current:	42,5-40,5/24,6-23,6 A
Starting current:	680-680 %
Cos phi - power factor:	0,83
Rated speed:	1470 rpm
Efficiency:	IE3 93,0%
Motor efficiency at full load:	93.0-93.0 %
Motor efficiency at 3/4 load:	93.7-93.7 %
Motor efficiency at 1/2 load:	93.7-93.7 %
Number of poles:	4

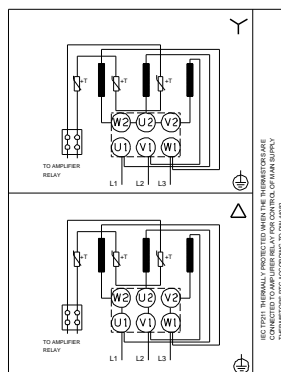
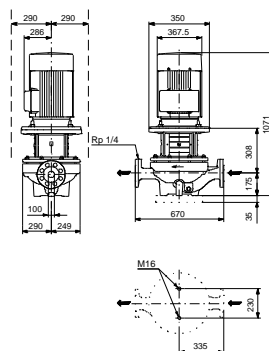
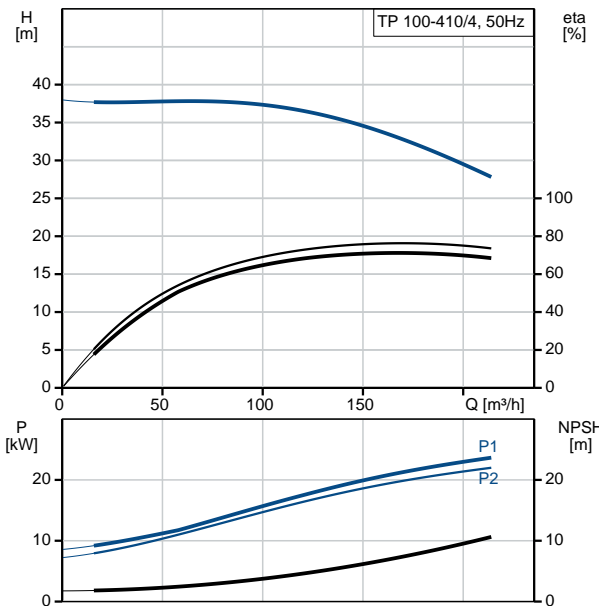



Company name:

Created by:

Phone:

Date:

31/08/2017

Description	Value
Enclosure class (IEC 34-5):	55 Dust/Jetting
Insulation class (IEC 85):	F
Motor protec:	PTC
Motor No:	99032118
Others:	
Minimum efficiency index, MEI :	0.69
ErP status:	EuP Standalone/Prod.
Net weight:	351 kg
Gross weight:	399 kg
Shipping volume:	1.12 m ³
Danish:	VVS NO 38 1716.410

96109311 TP 100-410/4 50 Hz

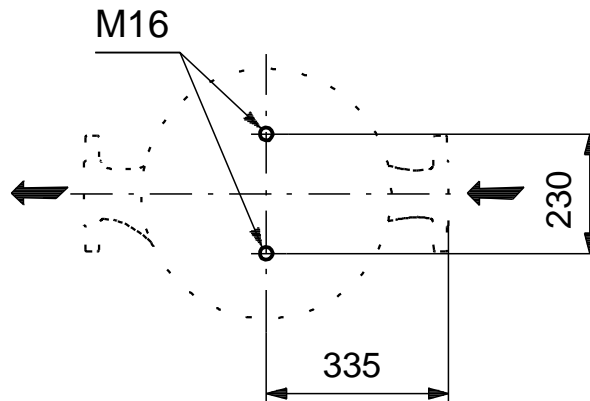
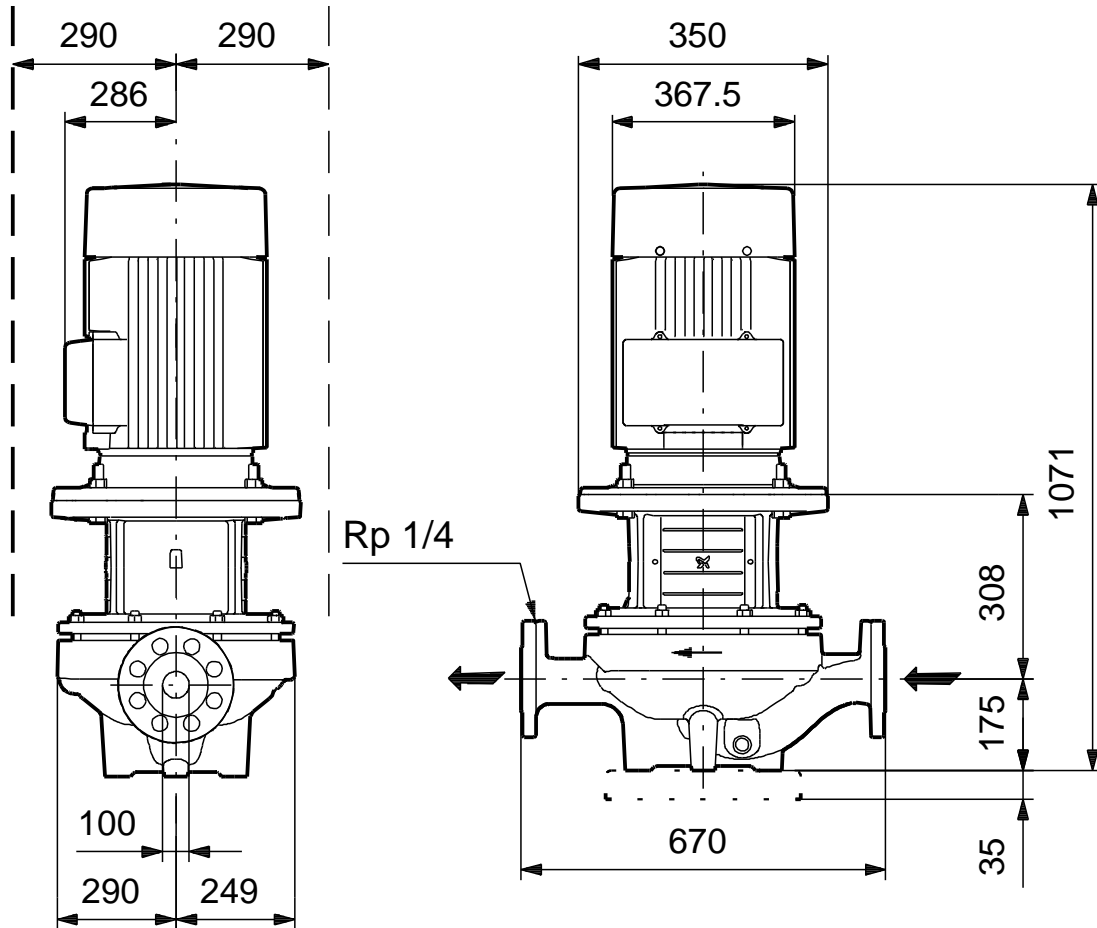

Note! All units are in [mm] unless others are stated.
Disclaimer: This simplified dimensional drawing does not show all details.

96109311 TP 100-410/4 50 Hz



IEC TP211 THERMALLY PROTECTED WHEN THE THERMISTORS ARE
CONNECTED TO AMPLIFIER RELAY FOR CONTROL OF MAIN SUPPLY
THERMISTORS PTC ACCORDING TO DIN 44082

Note! All units are in [mm] unless others are stated.