

Position	Qty.	Description
	1	<p><b>TP 100-200/4 A-F-A-BQQE</b></p>  <p>Product No.: <a href="#">96109307</a></p> <p>Single-stage, close-coupled, volute pump with in-line suction and discharge ports of identical diameter. The pump is of the top-pull-out design, i.e. the power head (motor, pump head and impeller) can be removed for maintenance or service while the pump housing remains in the pipework.</p> <p>The pump is fitted with an unbalanced rubber bellows seal. The shaft seal is according to EN 12756. Pipework connection is via PN 16 DIN flanges (EN 1092-2 and ISO 7005-2).</p> <p>The pump is fitted with a fan-cooled asynchronous motor.</p> <p><b>Liquid:</b>  Pumped liquid: Water  Liquid temperature range: -25 .. 120 °C  Liquid temperature during operation: 20 °C  Density: 998.2 kg/m<sup>3</sup></p> <p><b>Technical:</b>  Speed for pump data: 1455 rpm  Rated flow: 117 m<sup>3</sup>/h  Rated head: 16.32 m  Actual impeller diameter: 240 mm  Primary shaft seal: BQQE  Curve tolerance: ISO9906:2012 3B</p> <p><b>Materials:</b>  Pump housing: Cast iron  EN-JL1040  ASTM A48-40 B  Impeller: Cast iron  EN-JL1030  ASTM A48-30 B</p> <p><b>Installation:</b>  Range of ambient temperature: -30 .. 60 °C  Maximum operating pressure: 16 bar  Flange standard: DIN  Pipe connection: DN 100  Pump inlet: DN 100  Pump outlet: DN 100  Pressure stage: PN 16  Port-to-port length: 670 mm  Flange size for motor: FF265</p> <p><b>Electrical data:</b>  Motor type: 132MB  IE Efficiency class: IE3  Rated power - P2: 7.5 kW  Power (P2) required by pump: 7.5 kW  Mains frequency: 50 Hz</p>

Position	Qty.	Description
		<p>Rated voltage: 3 x 380-415D/660-690Y V            Rated current: 14,9-14,2/8,60-8,40 A            Starting current: 680-780 %            Cos phi - power factor: 0,86-0,82            Rated speed: 1460 rpm            Efficiency: IE3 90,4%            Motor efficiency at full load: 90.4 %            Motor efficiency at 3/4 load: 91.6 %            Motor efficiency at 1/2 load: 92.4 %            Number of poles: 4            Enclosure class (IEC 34-5): 55 Dust/Jetting            Insulation class (IEC 85): F</p> <p><b>Others:</b></p> <p>Label: Grundfos Blueflux            Minimum efficiency index, MEI : 0.45            ErP status: EuP Standalone/Prod.            Net weight: 228 kg            Gross weight: 261 kg            Shipping volume: 1.12 m<sup>3</sup>            Danish: VVS NO 38 1716.200</p>

## 96109307 TP 100-200/4 50 Hz

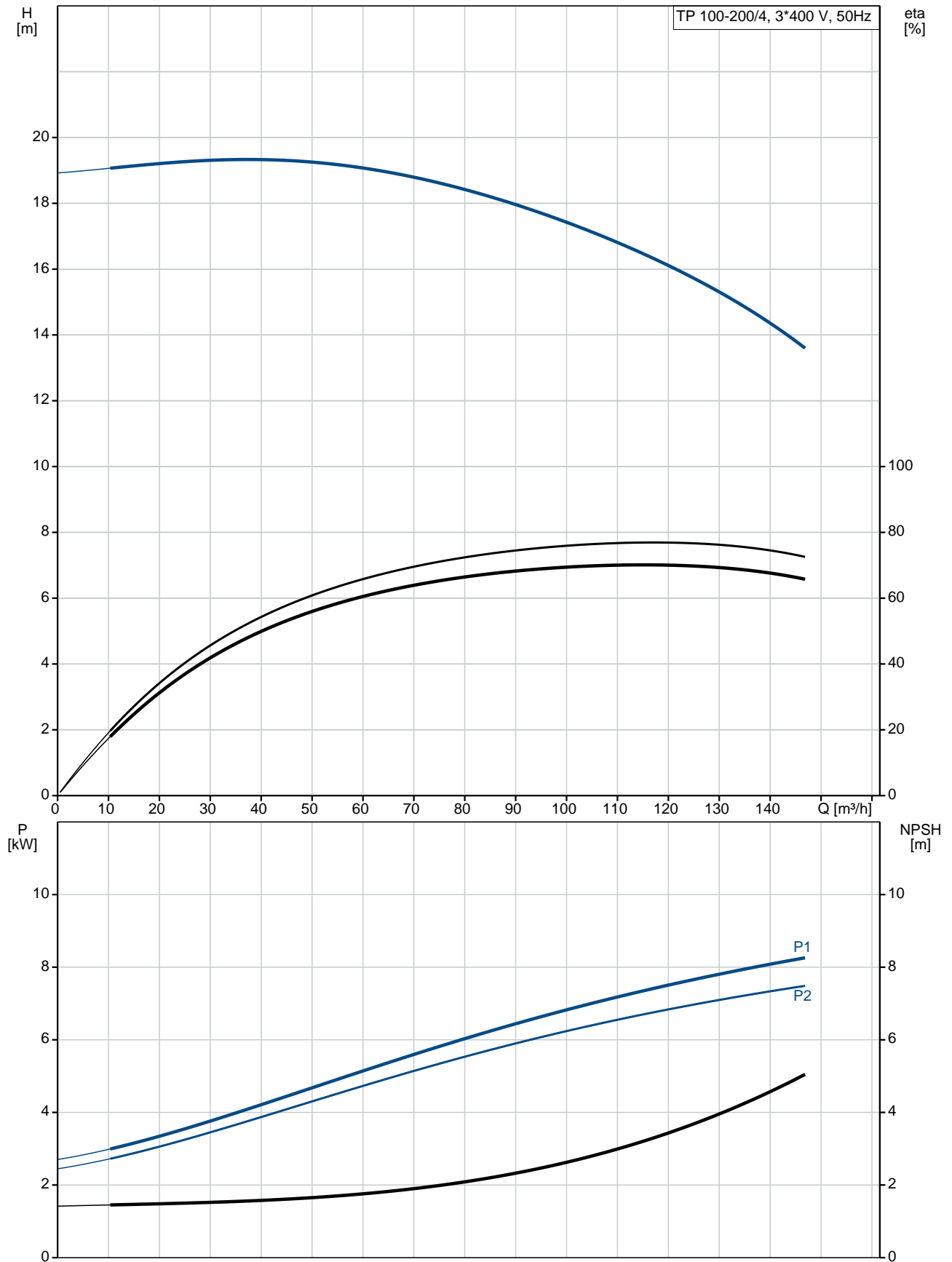

Description	Value
<b>General information:</b>	
Product name:	TP 100-200/4 A-F-A-BQQE
Product No:	96109307
EAN number:	5700396982847
<b>Technical:</b>	
Speed for pump data:	1455 rpm
Rated flow:	117 m <sup>3</sup> /h
Rated head:	16.32 m
Head max:	200 dm
Actual impeller diameter:	240 mm
Primary shaft seal:	BQQE
Curve tolerance:	ISO9906:2012 3B
Pump version:	A
Model:	A
<b>Materials:</b>	
Pump housing:	Cast iron EN-JL1040 ASTM A48-40 B
Impeller:	Cast iron EN-JL1030 ASTM A48-30 B
Material code:	A
<b>Installation:</b>	
Range of ambient temperature:	-30 .. 60 °C
Maximum operating pressure:	16 bar
Flange standard:	DIN
Connect code:	F
Pipe connection:	DN 100
Pump inlet:	DN 100
Pump outlet:	DN 100
Pressure stage:	PN 16
Port-to-port length:	670 mm
Flange size for motor:	FF265
<b>Liquid:</b>	
Pumped liquid:	Water
Liquid temperature range:	-25 .. 120 °C
Liquid temperature during operation:	20 °C
Density:	998.2 kg/m <sup>3</sup>
<b>Electrical data:</b>	
Motor type:	132MB
IE Efficiency class:	IE3
Rated power - P2:	7.5 kW
Power (P2) required by pump:	7.5 kW
Mains frequency:	50 Hz
Rated voltage:	3 x 380-415D/660-690Y V
Rated current:	14,9-14,2/8,60-8,40 A
Starting current:	680-780 %
Cos phi - power factor:	0,86-0,82
Rated speed:	1460 rpm
Efficiency:	IE3 90,4%
Motor efficiency at full load:	90.4 %
Motor efficiency at 3/4 load:	91.6 %
Motor efficiency at 1/2 load:	92.4 %
Number of poles:	4

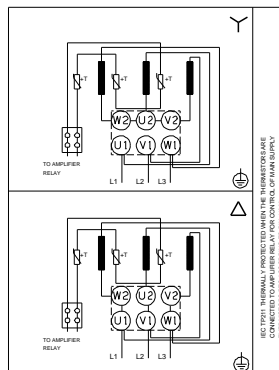
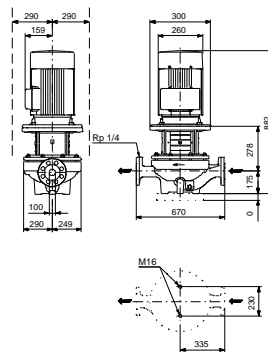
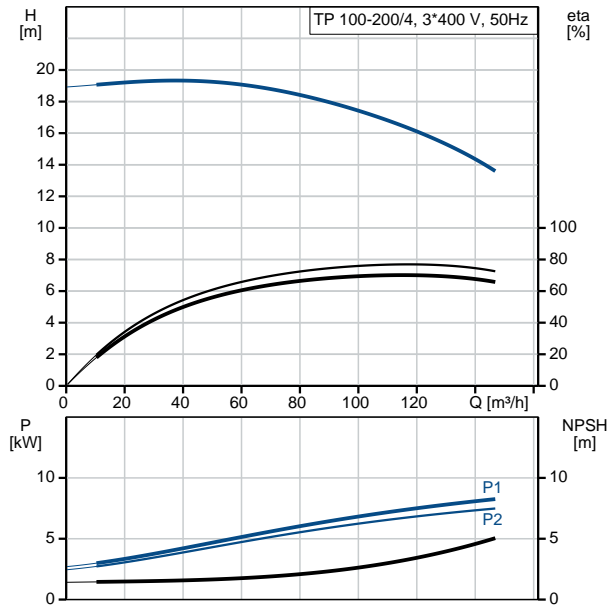



Company name:

Created by:

Phone:

Date:

31/08/2017

Description	Value
Enclosure class (IEC 34-5):	55 Dust/Jetting
Insulation class (IEC 85):	F
Motor protec:	PTC
Motor No:	87370262
<b>Others:</b>	
Label:	Grundfos Blueflux
Minimum efficiency index, MEI :	0.45
ErP status:	EuP Standalone/Prod.
Net weight:	228 kg
Gross weight:	261 kg
Shipping volume:	1.12 m <sup>3</sup>
Danish:	VVS NO 38 1716.200

**96109307 TP 100-200/4 50 Hz**

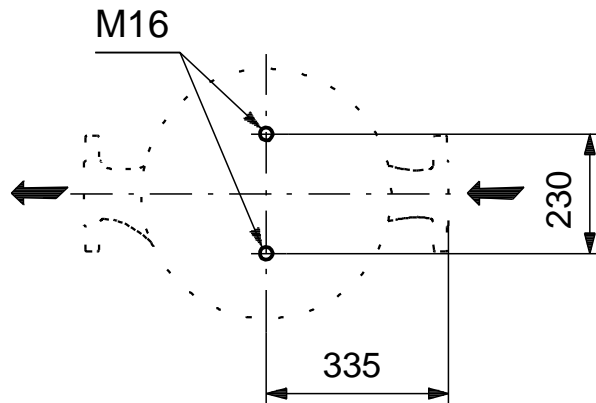
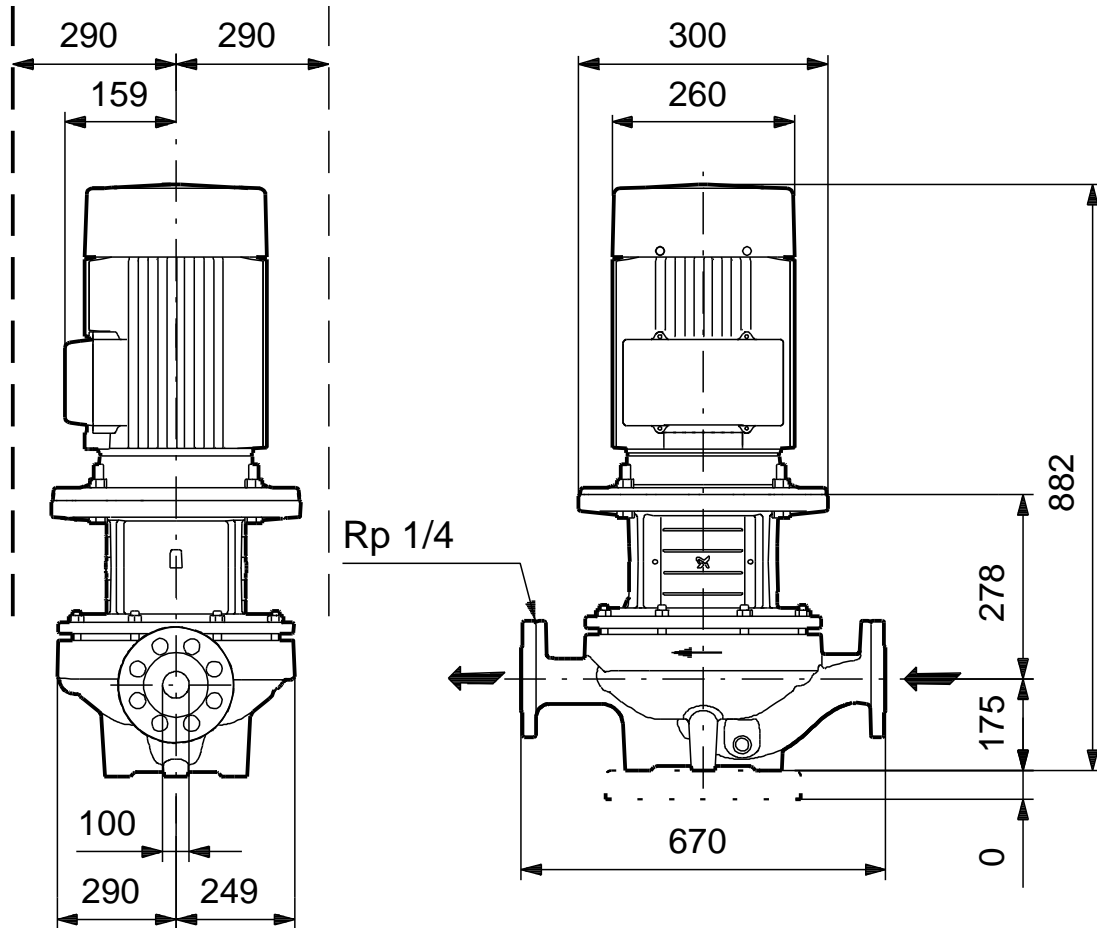

Note! All units are in [mm] unless others are stated.  
Disclaimer: This simplified dimensional drawing does not show all details.

## 96109307 TP 100-200/4 50 Hz



IEC TP211 THERMALLY PROTECTED WHEN THE THERMISTORS ARE  
CONNECTED TO AMPLIFIER RELAY FOR CONTROL OF MAIN SUPPLY  
THERMISTORS PTC ACCORDING TO DIN 44082

Note! All units are in [mm] unless others are stated.