

**Qty. Description**

1 SEV.80.80.22.4.50D



Note! Product picture may differ from actual product

Product No.: [96047781](#)

Non-self-priming, single-stage, centrifugal pump designed for handling wastewater, process water and unscreened raw sewage.

The pump is designed for intermittent and continuous operation. The liquidless and maintenance free cooling system ensures that the pump can be used for submerged or dry installation. The efficient SuperVortex impeller provides passage of long fibres and solids up to 80 mm and is suitable for wastewater with a dry matter content of up to 5 %.

A unique stainless-steel clamp assembling system enables quick and easy disassembly of the pump from the motor unit for service and inspection. No special tools are required. Pipework connection is via a DIN flange.

**Controls:**

Moisture sensor: without moisture sensors  
 Water-in-oil sensor: without water-in-oil sensor  
 Temp. sensor: N

**Liquid:**

Pumped liquid: Any Newtonian liquid  
 Liquid temperature range: 0 .. 40 °C  
 Density: 998.2 kg/m<sup>3</sup>

**Technical:**

Type of impeller: SUPER VORTEX  
 Maximum particle size: 80 mm  
 Primary shaft seal: SIC/SIC  
 Secondary shaft seal: CARBON/CERAMICS  
 Max. hydraulic efficiency: 48 %  
 Approvals on nameplate: EN12050-1  
 Curve tolerance: ISO9906:2012 3B2

**Materials:**

Pump housing: EN 1561 EN-GJL-250  
 Impeller: Cast iron

**Installation:**

Maximum ambient temperature: 40 °C  
 Maximum operating pressure: 6 bar  
 Flange standard: DIN  
 Pump outlet: DN 80  
 Pressure rating: PN 10  
 Maximum installation depth: 20 m

**Electrical data:**

Power input - P1: 2.9 kW  
 Rated power - P2: 2.2 kW  
 Mains frequency: 50 Hz  
 Rated voltage: 3 x 380-415 V

Qty.	Description
	<p>Voltage tolerance: +6/-10 %</p> <p>Max starts per. hour: 20</p> <p>Rated current: 6.0-6.0 A</p> <p>Rated current at 3/4 load: 4.8 A</p> <p>Rated current at 1/2 load: 4.2 A</p> <p>Starting current: 32 A</p> <p>Rated current at no load: 3.6 A</p> <p>Cos phi - power factor: 0.74</p> <p>Cos phi - p.f. at no load: 0.13</p> <p>Cos phi - p.f. at 3/4 load: 0.66</p> <p>Cos phi - p.f. at 1/2 load: 0.53</p> <p>Rated speed: 1445 rpm</p> <p>Locked-rotor torque: 32 Nm</p> <p>Breakdown torque: 45 Nm</p> <p>Moment of inertia: 0.024 kg m<sup>2</sup></p> <p>Motor efficiency at full load: 76.3 %</p> <p>Motor efficiency at 3/4 load: 75.2 %</p> <p>Motor efficiency at 1/2 load: 70.9 %</p> <p>Number of poles: 4</p> <p>Start. method: direct-on-line</p> <p>Enclosure class (IEC 34-5): IP68</p> <p>Insulation class (IEC 85): F</p> <p>Explosion proof: no</p> <p>Length of cable: 10 m</p> <p>Cable type: LYNIFLEX</p> <p>Type of cable plug: NO PLUG</p> <p><b>Others:</b></p> <p>Net weight: 106 kg</p> <p>Country of origin: HU</p> <p>Custom tariff no.: 84137021</p>

## 96047781 SEV.80.80.22.4.50D 50 Hz

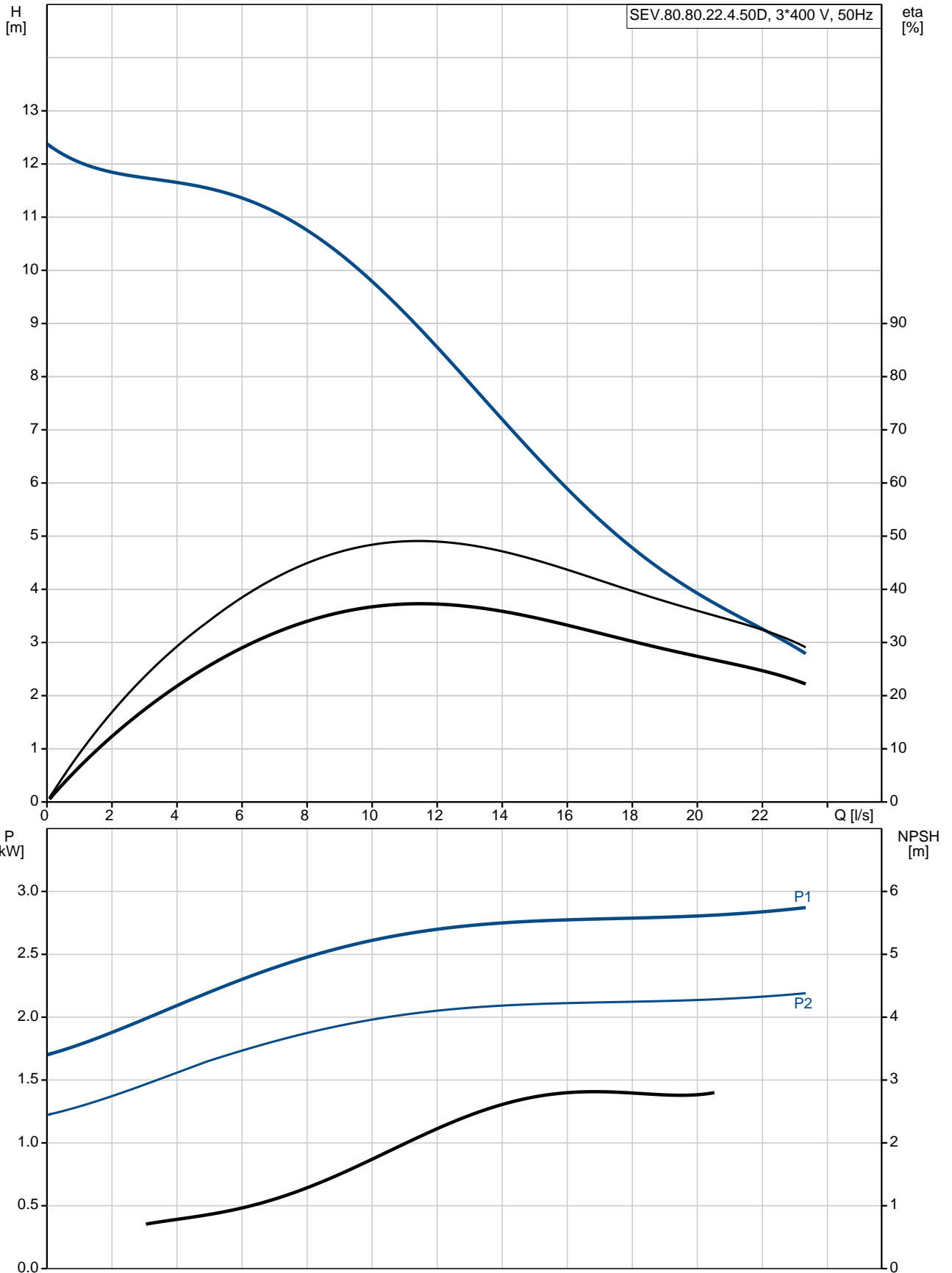

Description	Value
<b>General information:</b>	
Product name:	SEV.80.80.22.4.50D
Product No:	96047781
EAN number:	5700395070309
	5700395070309
Price:	2.676,00 GBP
<b>Technical:</b>	
Max flow:	23.3 l/s
Head max:	12.4 m
Type of impeller:	SUPER VORTEX
Maximum particle size:	80 mm
Primary shaft seal:	SIC/SIC
Secondary shaft seal:	CARBON/CERAMICS
Max. hydraulic efficiency:	48 %
Approvals on nameplate:	EN12050-1
Curve tolerance:	ISO9906:2012 3B2
Cooling jacket:	with cooling jacket
<b>Materials:</b>	
Pump housing:	EN 1561 EN-GJL-250
Impeller:	Cast iron
<b>Installation:</b>	
Maximum ambient temperature:	40 °C
Maximum operating pressure:	6 bar
Flange standard:	DIN
Pump outlet:	DN 80
Pressure rating:	PN 10
Maximum installation depth:	20 m
Inst dry/wet:	DRY/SUBMERGED
Installation:	horizontal or vertical
<b>Liquid:</b>	
Pumped liquid:	Any Newtonian liquid
Liquid temperature range:	0 .. 40 °C
Density:	998.2 kg/m <sup>3</sup>
<b>Electrical data:</b>	
Power input - P1:	2.9 kW
Rated power - P2:	2.2 kW
Mains frequency:	50 Hz
Rated voltage:	3 x 380-415 V
Voltage tolerance:	+6/-10 %
Max starts per. hour:	20
Rated current:	6.0-6.0 A
Rated current at 3/4 load:	4.8 A
Rated current at 1/2 load:	4.2 A
Starting current:	32 A
Rated current at no load:	3.6 A
Cos phi - power factor:	0.74
Cos phi - p.f. at no load:	0.13
Cos phi - p.f. at 3/4 load:	0.66
Cos phi - p.f. at 1/2 load:	0.53
Rated speed:	1445 rpm
Locked-rotor torque:	32 Nm
Breakdown torque:	45 Nm
Moment of inertia:	0.024 kg m <sup>2</sup>
Motor efficiency at full load:	76.3 %
Motor efficiency at 3/4 load:	75.2 %
Motor efficiency at 1/2 load:	70.9 %
Number of poles:	4
Start. method:	direct-on-line

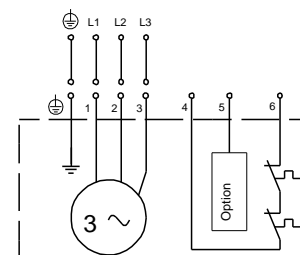
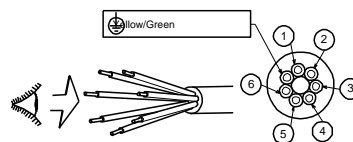
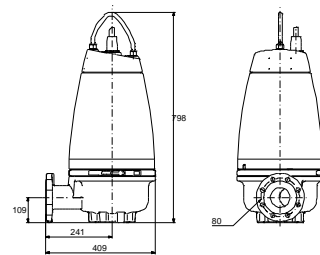
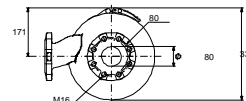
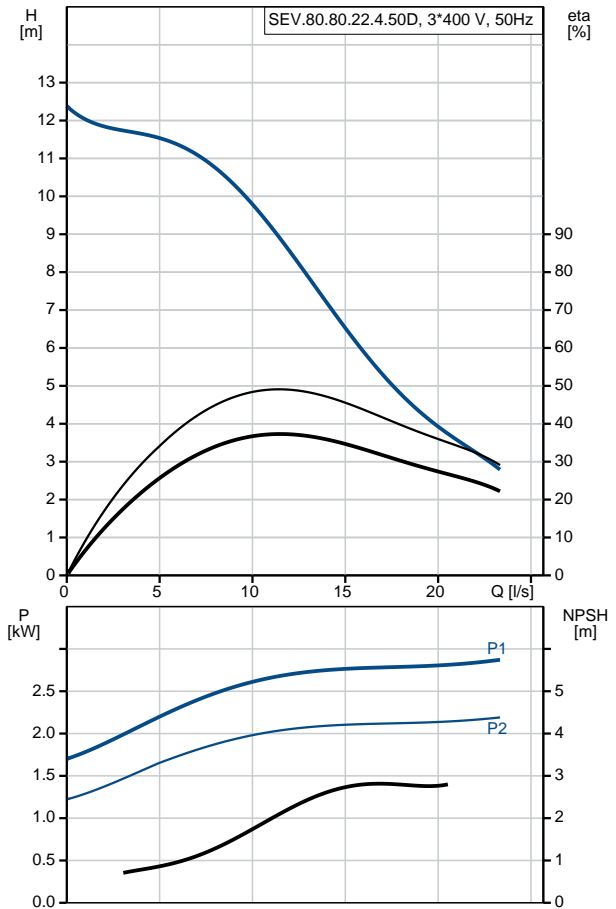



Company name:

Created by:

Phone:

Date:

28/01/2020

Description	Value
Enclosure class (IEC 34-5):	IP68
Insulation class (IEC 85):	F
Explosion proof:	no
Motor protec:	THERMAL SWITCH
Thermal protec:	internal
Length of cable:	10 m
Cable type:	LYNIFLEX
Type of cable plug:	NO PLUG
<b>Controls:</b>	
Control box:	not included
Moisture sensor:	without moisture sensors
Water-in-oil sensor:	without water-in-oil sensor
Temp. sensor:	N
<b>Others:</b>	
Net weight:	106 kg
Country of origin:	HU
Custom tariff no.:	84137021

## 96047781 SEV.80.80.22.4.50D 50 Hz

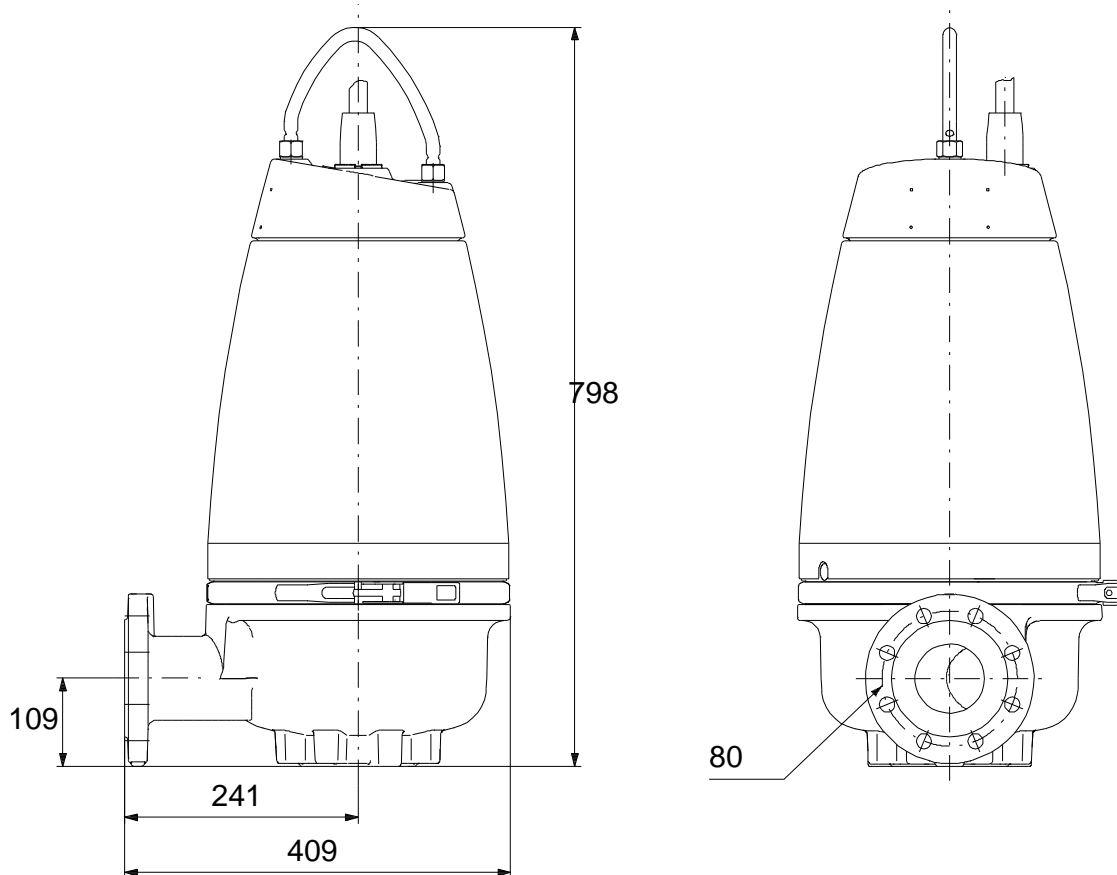
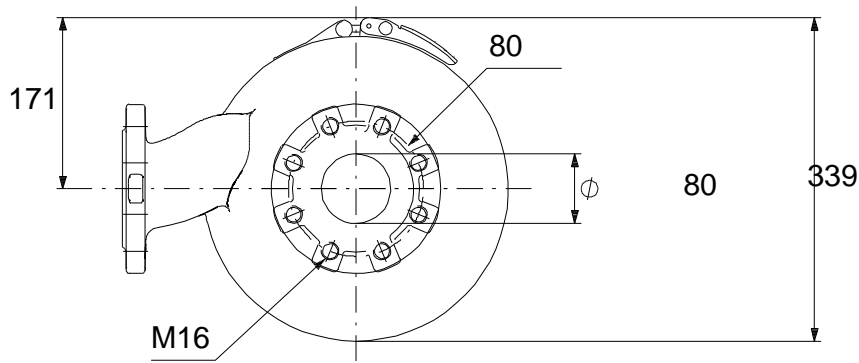

Note! All units are in [mm] unless others are stated.  
Disclaimer: This simplified dimensional drawing does not show all details.

## 96047781 SEV.80.80.22.4.50D 50 Hz

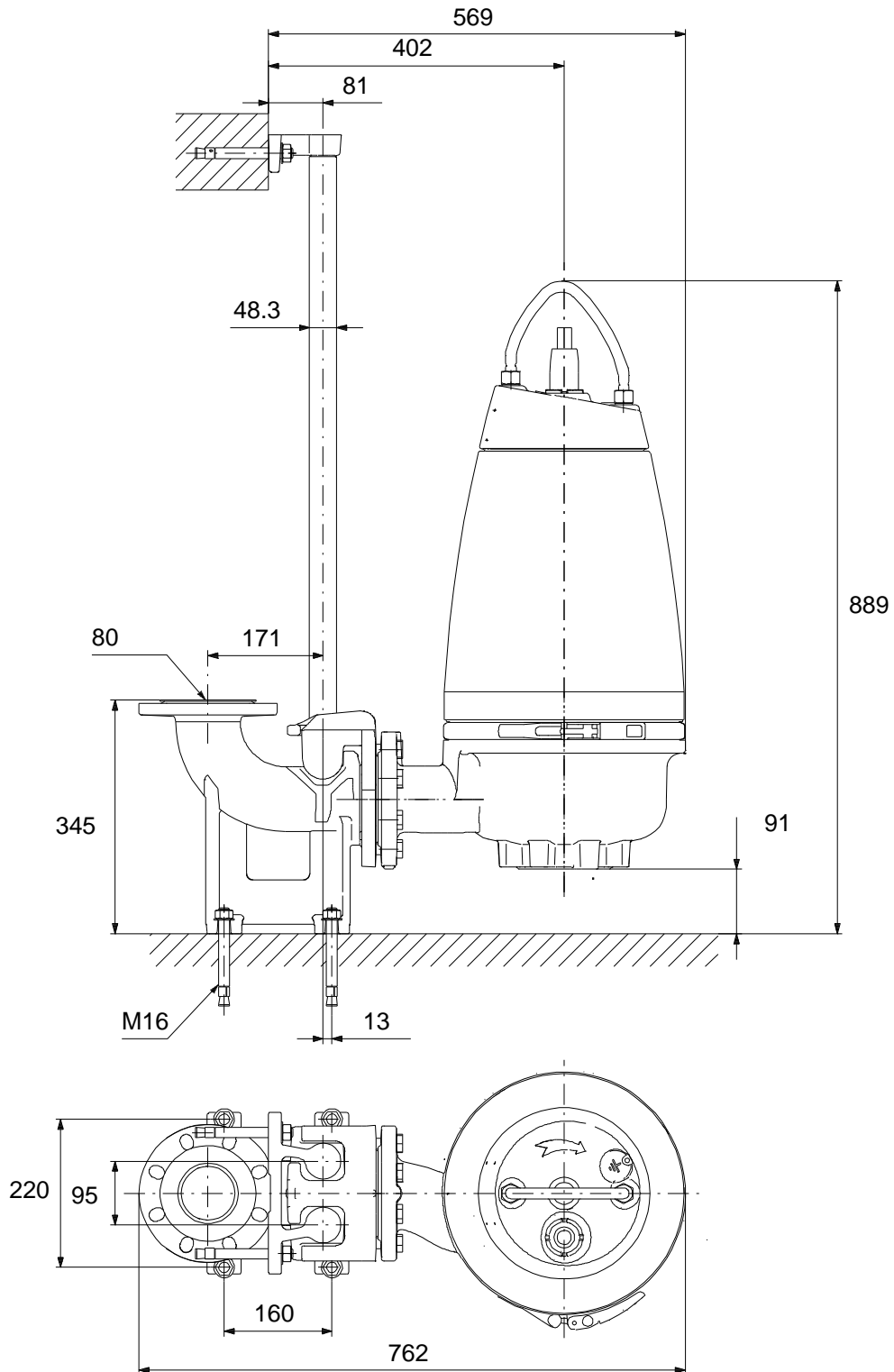

Note! All units are in [mm] unless others are stated.  
Disclaimer: This simplified dimensional drawing does not show all details.

## 96047781 SEV.80.80.22.4.50D 50 Hz

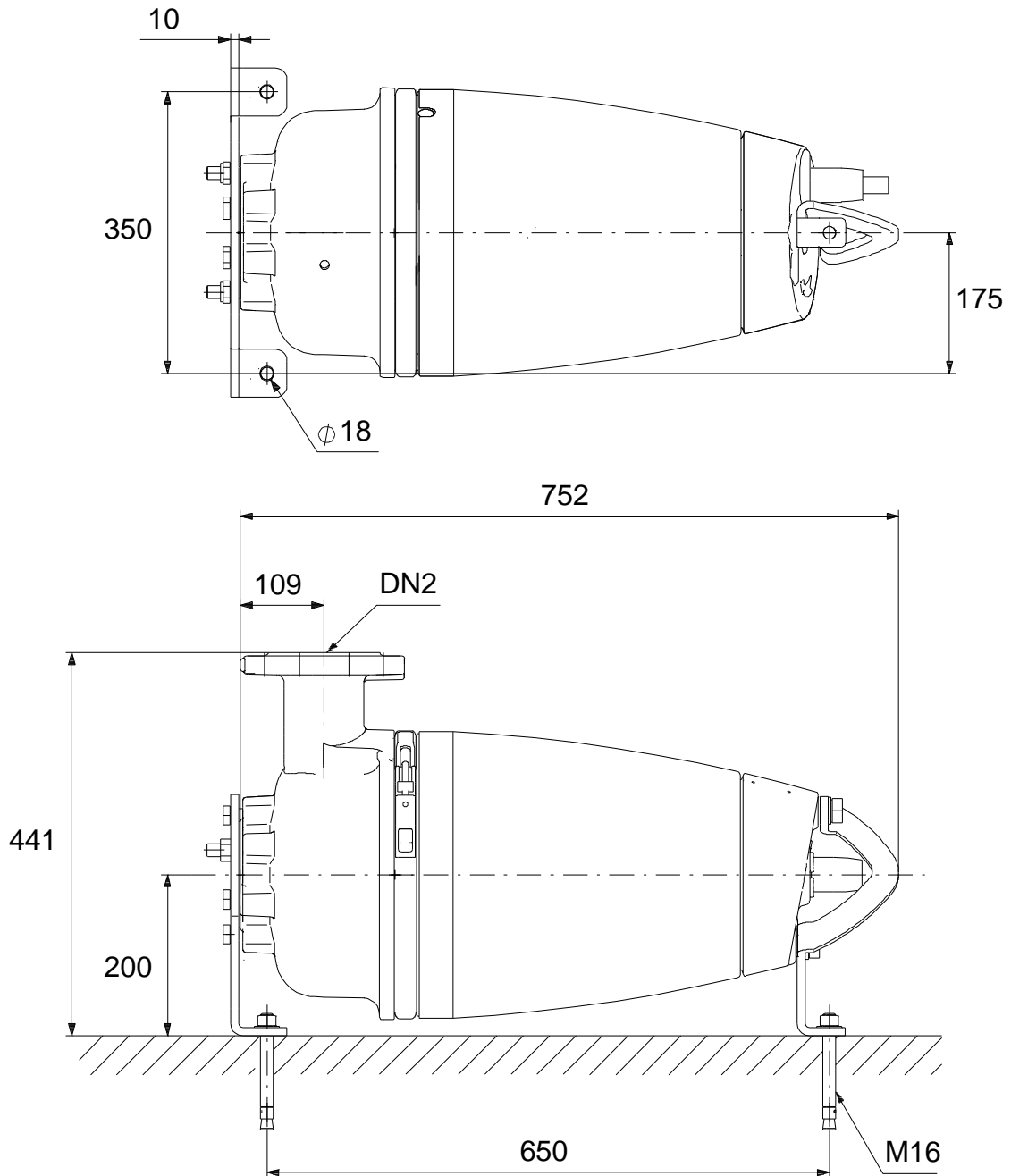

Note! All units are in [mm] unless others are stated.  
Disclaimer: This simplified dimensional drawing does not show all details.



## 96047781 SEV.80.80.22.4.50D 50 Hz

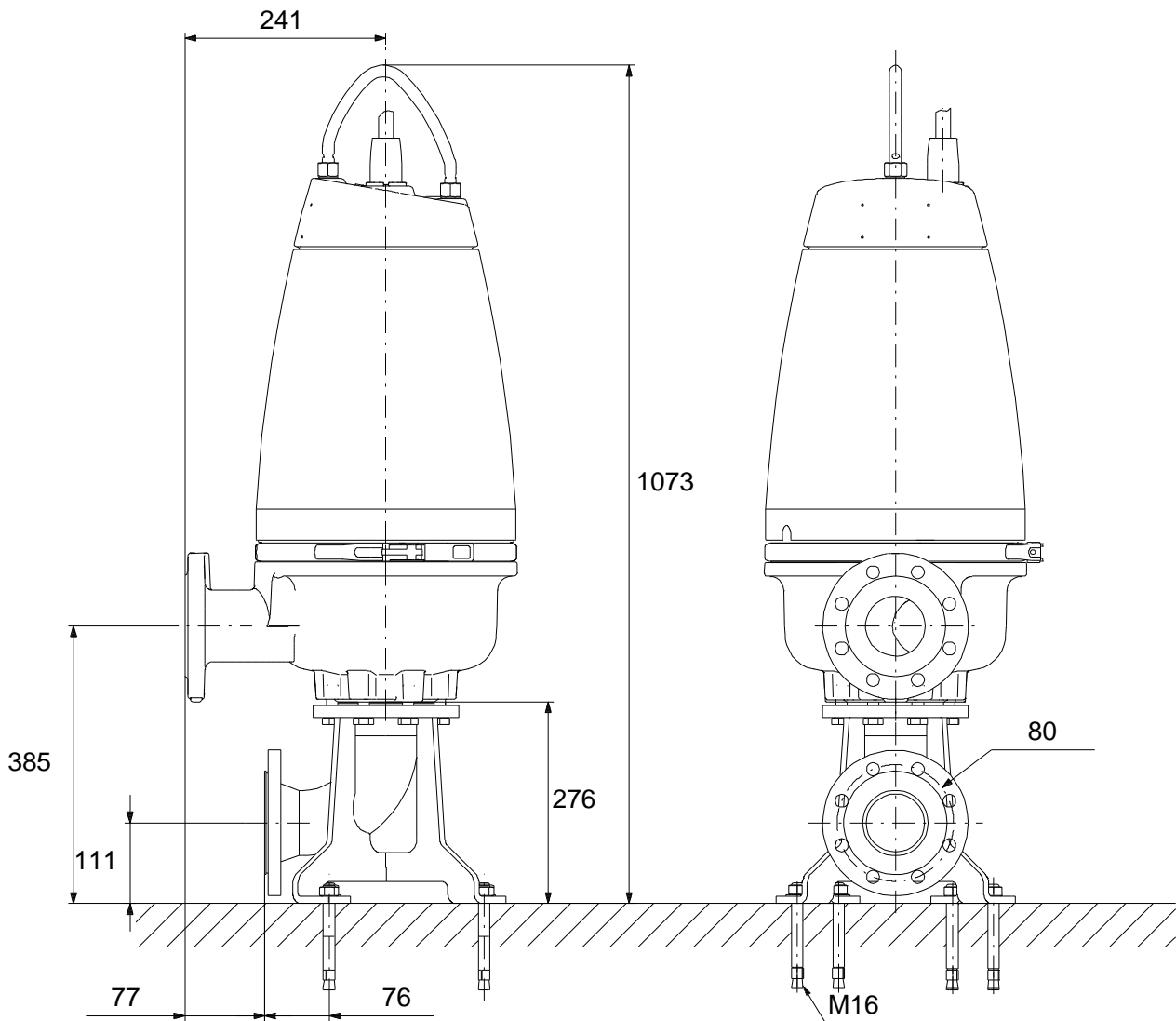
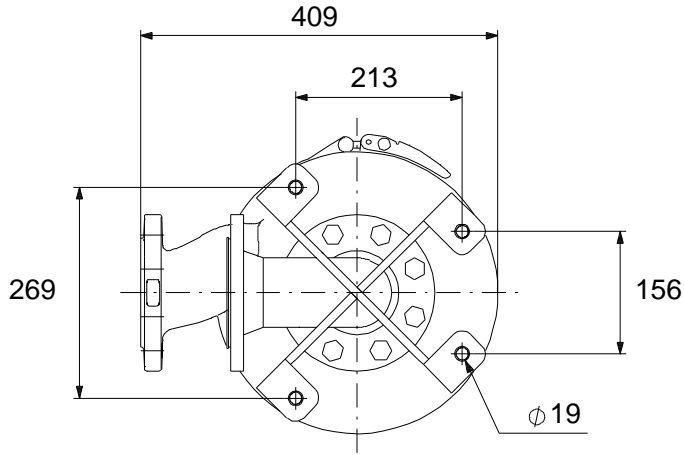

Note! All units are in [mm] unless others are stated.  
Disclaimer: This simplified dimensional drawing does not show all details.

## 96047781 SEV.80.80.22.4.50D 50 Hz

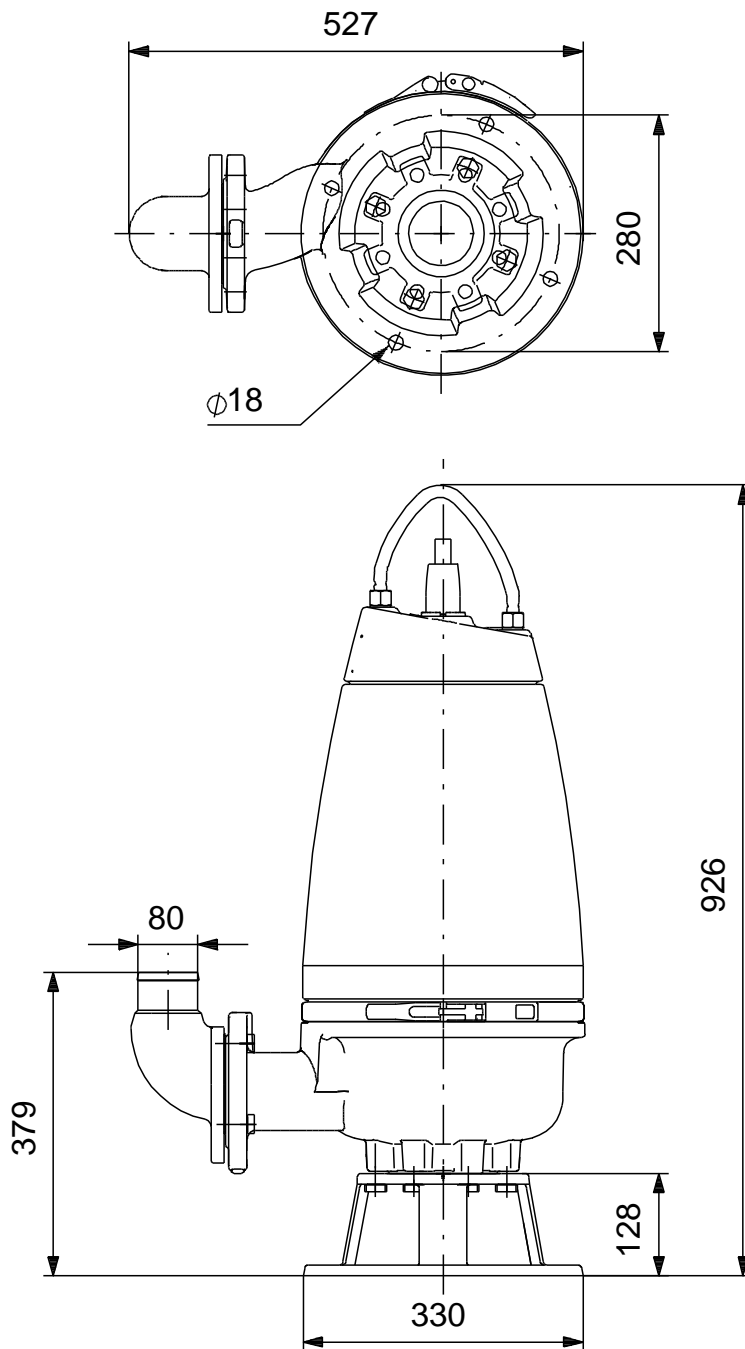

Note! All units are in [mm] unless others are stated.  
Disclaimer: This simplified dimensional drawing does not show all details.