

Hydraulic data

Maximum operating pressure <i>PN</i>	10 bar
Max. delivery head <i>H</i>	8.50 m
Max. volume flow <i>Q</i>	18.2 m ³ /h
Min. fluid temperature for HVAC applications <i>T_{min}</i>	-20 °C
Max. fluid temperature for HVAC <i>T</i>	110 °C
Min. ambient temperature <i>T_{min}</i>	0 °C
Max. ambient temperature <i>T_{max}</i>	40 °C
Max. permitted total water hardness	3.57 mmol/l (20°dH)

Materials

Pump housing	Bronze
Impeller	PPS-GF40
Shaft	Stainless steel
Bearing	Carbon, synthetic resin-impregnated

Motor data

Energy efficiency index (EEI)	0.20
Mains connection	1~230 V, 50/60 Hz
Rated power <i>P₂</i>	0.20 kW
Rated current <i>I_N</i>	1.33 A
Min. speed <i>n_{min}</i>	1200 1/min
Max. speed <i>n_{max}</i>	4800 1/min
Power consumption <i>P_{1min}</i>	10.0 W
Power consumption <i>P_{1max}</i>	305.0 W
Interference emission	EN 61800-3;2004+A1;2012 /residential area (C1)
Interference immunity	EN 61800-3;2004+A1;2012 /industrial environment (C2)
Speed control	Frequency converter
Insulation class	F
Protection class motor	IPX4D
Motor protection	Internal protection overheating and overcurrent

Installation dimensions

Pipe connection on the suction side <i>DN_s</i>	DN 40
Pipe connection on the pressure side <i>DN_d</i>	DN 40
Port-to-port length <i>L₀</i>	220 mm

Yonos MAXO-Z 40/0,5-8

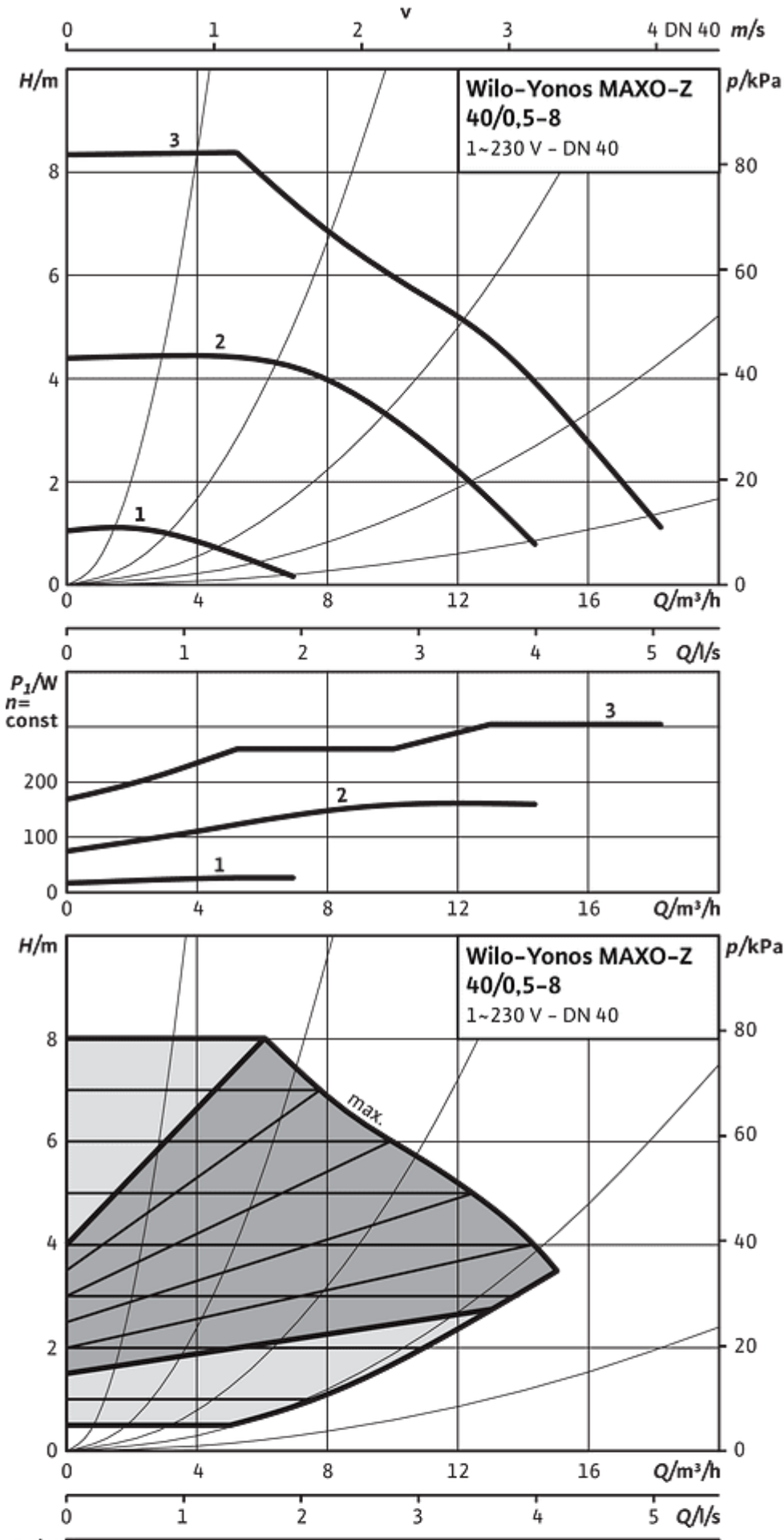

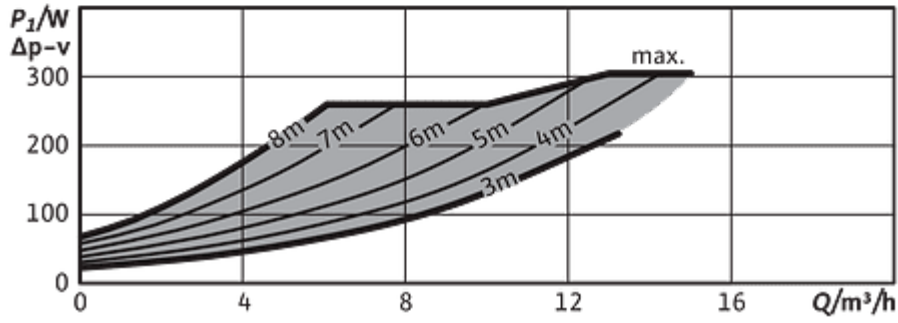
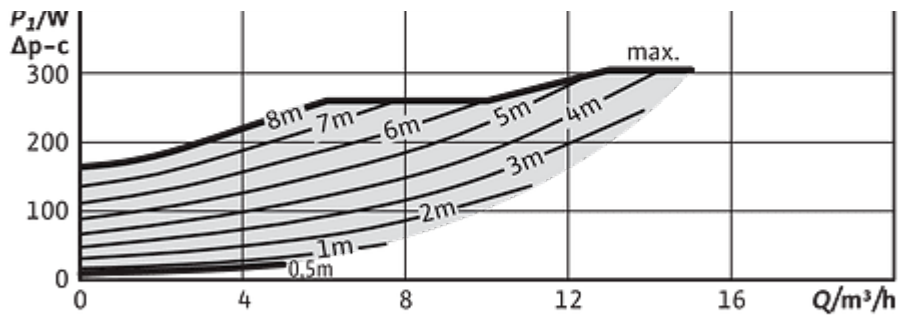

Yonos MAXO

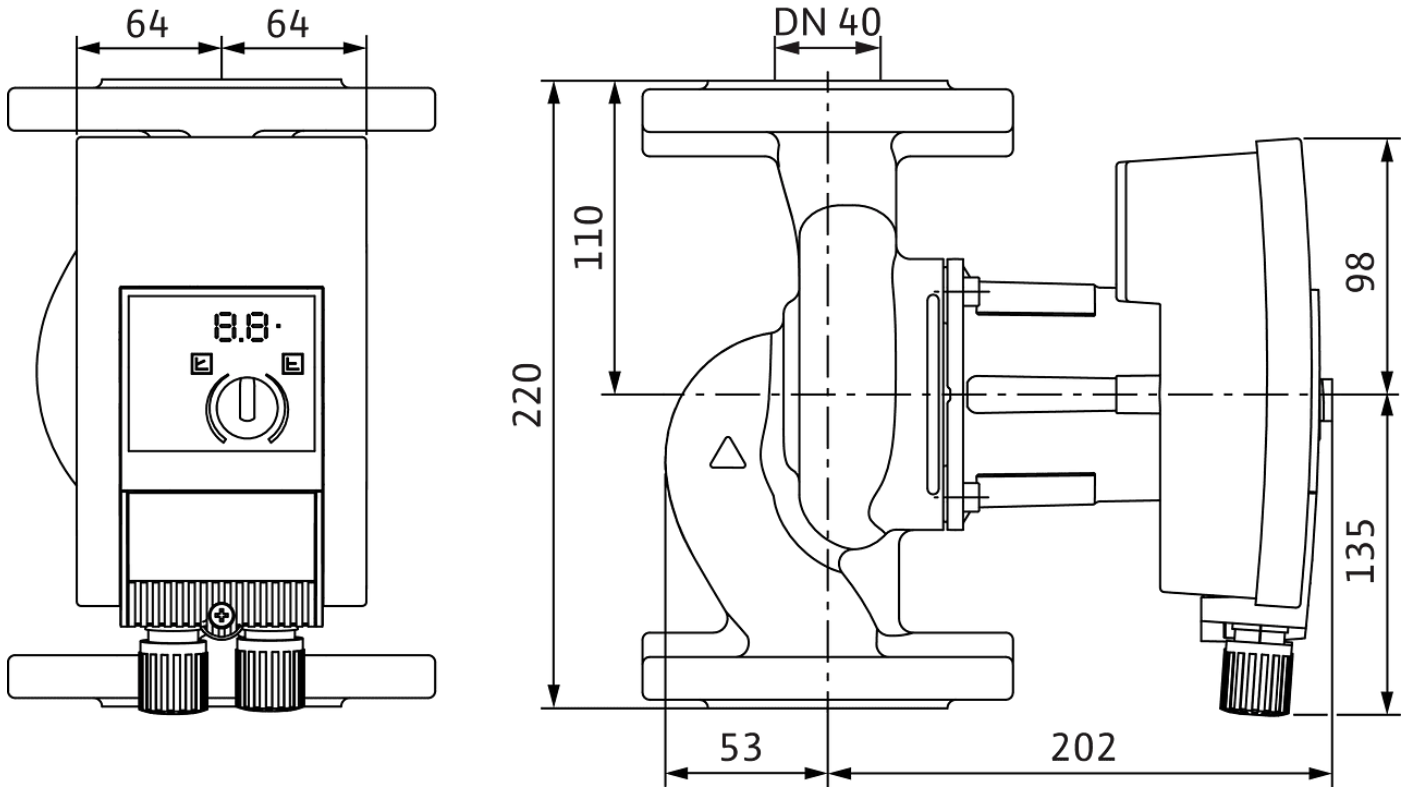

Yonos MAXO-Z 40/0,5-8 PN 6/10

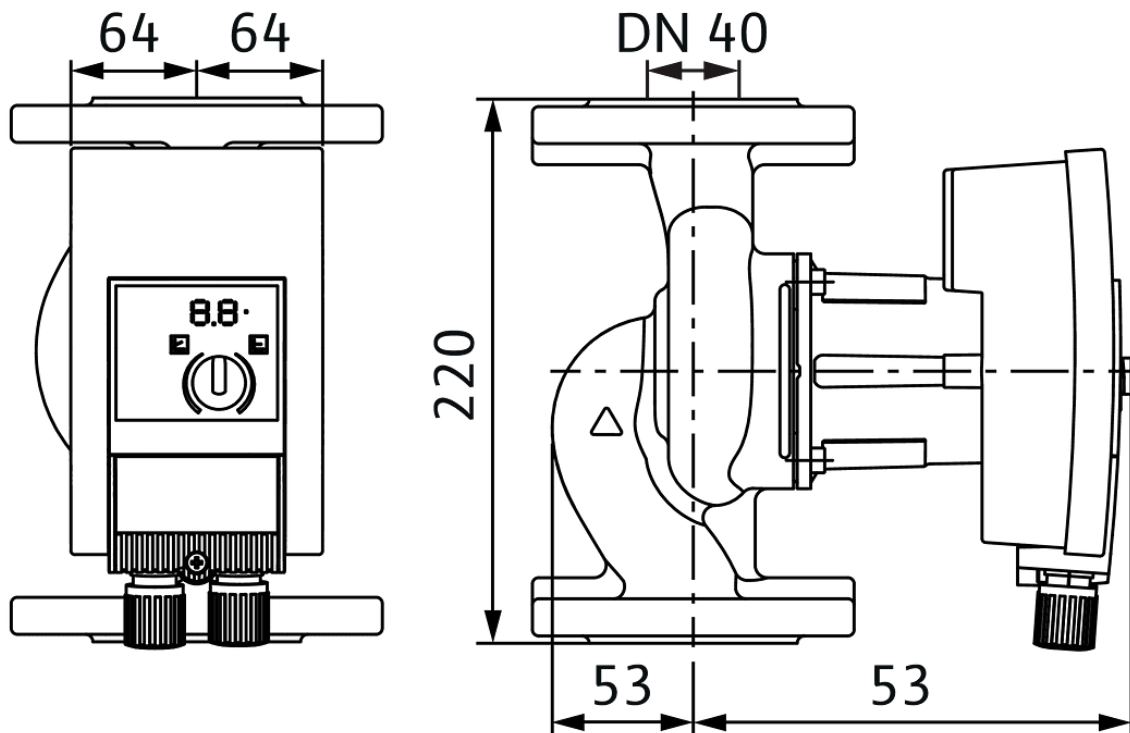

1~230V, 50/60 Hz

1~ 230 V, 50/60 Hz

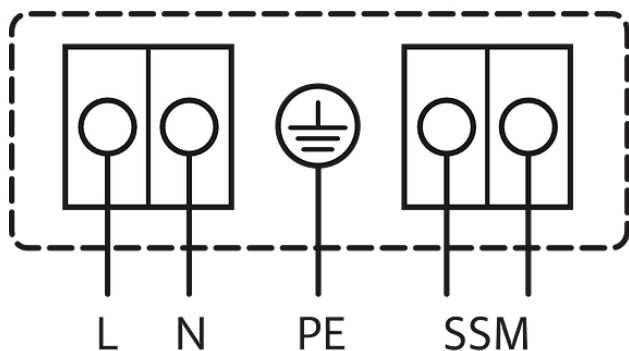

3~230 V, 50/60 Hz

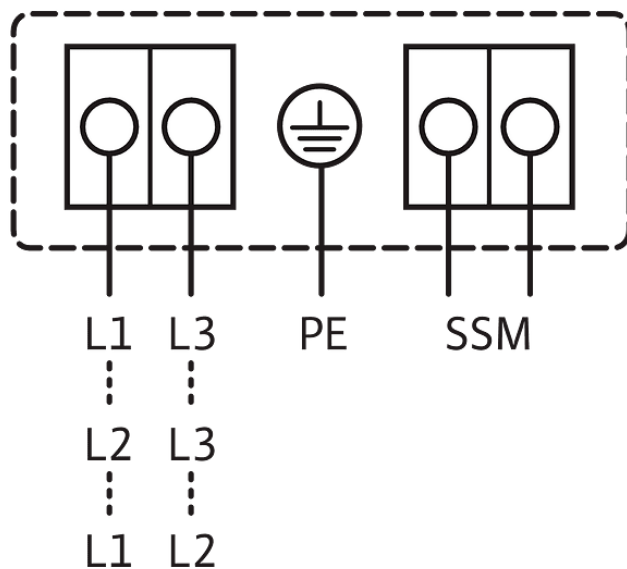

SSM: Collective fault signal
(NC contact in accordance with VDI 3814, load capacity 1 A, 250 V ~)

Standard: 1~230 V, 50/60 Hz

Option: 3~230 V, 50/60 Hz

Product data

Brand	Wilo
Product description	Yonos MAXO-Z 40/0,5-8 PN 6/10
Article number	2175542
EAN number	4048482739823
Colour	green/bronze
Minimum order quantity	1
Date of sales availability	2017-03-01

Dimension, weight

Length with packaging	325 mm
Length <i>L</i>	245 mm
Height with packaging	215 mm
Height <i>H</i>	277 mm
Width with packaging	305 mm
Width <i>W</i>	150 mm
Gross weight, approx. <i>m</i>	13.0 kg
Net weight, approx. <i>m</i>	11 kg

Packaging

Number per layer	9
Packaging property	Transport packaging
Packaging type	Cardboard box
Pieces per pallet	36

High-efficiency pump Wilo-Yonos MAXO-Z

electronically controlled,

Glandless circulator, synchronous motor according to ECM technology and integrated power control for continuous differential pressure control. Can be used for all domestic hot water circulation systems in industry and building services.

Standard-equipped with:

- > Preselectable control modes for optimum load adjustment: Δp -c (constant differential pressure), Δp -v (variable differential pressure)
- > 3 speed stages (n = constant)
- > LED for setting the setpoint and displaying error messages
- > Electrical connection with the Wilo plug
- > Fault signal light and contact for collective fault signal

For flange-end pumps - flange versions:

- > Standard version for DN 32 to DN 65 pumps: Combination flange PN 6/10 (flange PN 16 in accordance with EN 1092-2) for counter flanges PN 6 and PN 10

Operating data

Fluid media	Water
Fluid temperature T	-20 °C
Ambient temperature T	0 °C
Maximum operating pressure PN	10 bar
Minimum suction head at 50 °C m	3.0 m
Minimum suction head at 95 °C m	10.0 m
Minimum suction head at 110 °C	16.0 m
Max. permitted total water hardness	3.57 mmol/l (20°dH)

Motor data

Energy efficiency index (EEI)	0.20
Interference emission	EN 61800-3;2004+A1;2012 /residential area (C1)
Interference immunity	EN 61800-3;2004+A1;2012 /industrial environment (C2)
Mains connection	1~230 V, 50/60 Hz
Power consumption $P_{1\max}$	305.0 W
Min. speed n_{\min}	1200 1/min
Max. speed n_{\max}	4800 1/min
Protection class motor	IPX4D
Threaded cable connection	2 x M20x1.5

Materials

Pump housing	Bronze
Impeller	PPS-GF40
Shaft	Stainless steel
Bearing	Carbon, synthetic resin-impregnated

Installation dimensions

Pipe connection on the suction side DN_s	DN 40
Pipe connection on the pressure side DN_d	DN 40
Port-to-port length LO	220 mm

Information for order placements

Brand	Wilo
Product description	Yonos MAXO-Z 40/0,5-8 PN 6/10
Net weight, approx. <i>m</i>	11 kg
Article number	2175542