

LNEEE40-125/15/EP05CS4

Technical data

Company name
Contact
Phone number
e-mail address

Operating data

Pump type	Single head pump	Fluid	Water, pure
No. of pumps / Reserve	1 / 0	Operating temperature t A	°C 4
Nominal flow	m ³ /h 0	pH-value at t A	7
Nominal head	m 0	Density at t A	kg/m ³ 1000
Static head	m 0	Kin. viscosity at t A	mm ² /s 1.569
Inlet pressure	kPa 0	Vapor pressure at t A	kPa 100
Environmental temperature	°C 20	Solids	0
Available system NPSH	m 0	Altitude	m 0

Pump data

Make	Lowara	Nominal	m ³ /h ()
Speed	rpm 2900	Flow	Max- m ³ /h 28
Number of stages	1		Min- m ³ /h
Max. casing pressure	kPa	Nominal	m
Max. working pressure	kPa 253.7	Head	at Qmax m 8.6
Head H(Q=0)	m 26		at Qmin m 25.9
Weight	kg 34	Shaft power	kW ()
	Max. mm	Max. shaft power	kW
Impeller R	designed mm	Efficiency (Hydraulic+Motor+Drive)	%
	Min. mm	NPSH 3%	m

Pump Materials

Volute Casing	Cast iron
Casing Cover	Cast iron
Impeller	Stainless steel / AISI 304
Stub shaft	Stainless steel / AISI 316L
Wear Ring	Stainless steel / AISI 304
Impeller lock nut and washer	Stainless steel / AISI 304
Impeller key	Stainless steel / AISI 316L
Fill and drain plugs	Nickel-plated brass

Shaft Seal

Unbalanced mechanical seal	Burgmann
eMG12 (-25 / +90 °C)	
1. Rotating ring	Carbon graphite resin impregnated
2. Stationary ring	SiC, silicon carbide, sintered press. less
3. Secondary seal	Ethylene propylene rubber (EPDM)
4. Springs	CrNiMo - Steel
5. Others	EPDM - WRAS
Gaskets of the pump	Ethylene propylene rubber (EPDM)
Code	B/ESIC-Q7EGG/Y 10-WA

Motor data

Manufacturer	Lowara	Electric voltage	460 V	Speed	2900 rpm	Insulation class	B
Specific design	Three phase e-SM motor			Frame size	90R	Colour	RAL 5010
Type	ESM90R../315 LNEE	Electric current	4.32 A				
Rated power	1.5 kW	Degree of protection	IP 55				

Remarks:

LNEEE40-125/15/EP05CS4

Performance curve

Company name
Contact
Phone number
e-mail address

Hydraulic data

Operating Data Specification		Hydraulic data (duty point)		Impeller design	
Flow	0 m ³ /h	Flow		Impeller R	0 mm
Head	0 m	Head		Frequency	50 Hz
Static head	0 m			Speed	2900 rpm

Power datas referred to:
Water, pure [100%] ; 4°C; 1000kg/m³; 1.57mm²/s
Performance according to ISO 9906:2012 – Grade 3B



LNEEE40-125/15/EP05CS4

Dimensions

Company name
Contact
Phone number
e-mail address

Dimensions mm/l

b1	128		
b2	120		
Bmax	285		
DND	40		
DNS	40		
e	100		
H	320		
h1	160		
h2	160		
L	452		
x	260		
		Total weight	33.9 kg

Connections mm

Suction nozzle Discharge nozzle

--	--	--	--

Drawing

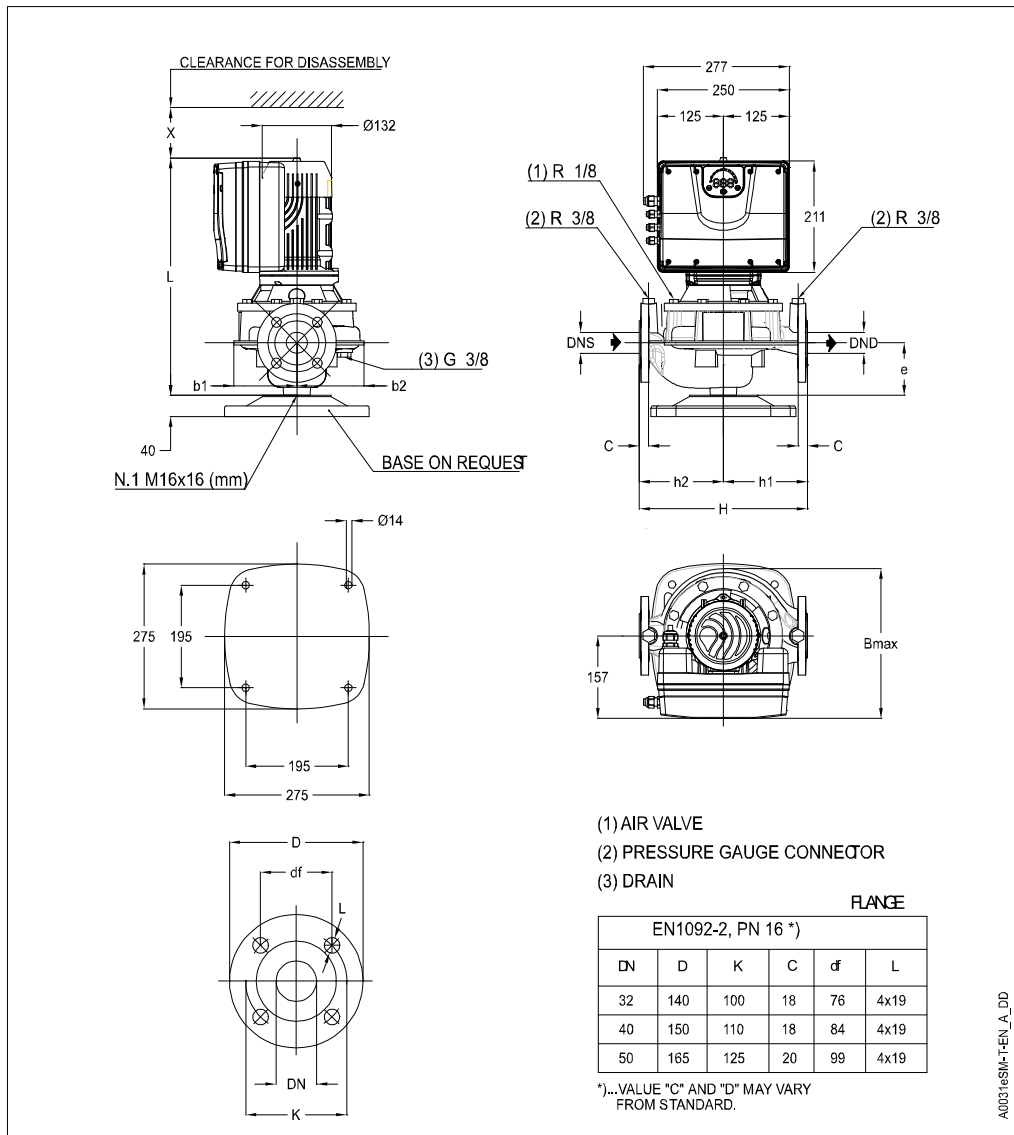

LNEEE40-125/15/EP05CS4

Total lifetime	15	Inflation rate (rate of price increases)	2 %
Annual operating time	5600	Interest rate (for investment)	3 %
Energy cost per kWh	0.00 GBP		
Power input P1			

Total costs

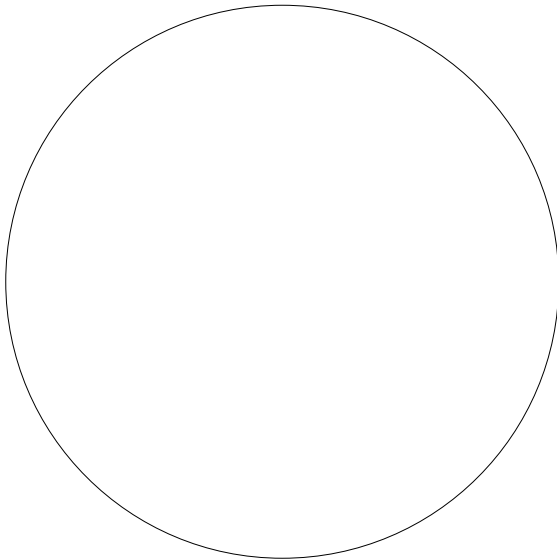

- 0%** **0.00 GBP** Energy
- 0%** **0.00 GBP** Investment costs
- 0%** **0.00 GBP** Installation & commissioning
- 0%** **0.00 GBP** Operating cost
- 0%** **0.00 GBP** Maintenance & repair
- 0%** **0.00 GBP** Downtime
- 0%** **0.00 GBP** Environmental
- 0%** **0.00 GBP** Decommissioning

GBP

First year costs

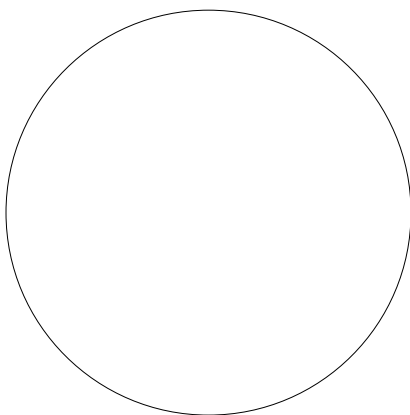

- 0%** **0.00 GBP** Energy (1st year)
- 0%** **0.00 GBP** Investment costs (1st year)
- 0%** **0.00 GBP** Installation & commissioning (1st year)
- 0%** **0.00 GBP** Operating cost (1st year)
- 0%** **0.00 GBP** Maintenance & repair (1st year)
- 0%** **0.00 GBP** Downtime (1st year)
- 0%** **0.00 GBP** Environmental (1st year)
- 0%** **0.00 GBP** Decommissioning (1st year)

GBP

Disclaimer: The calculations and the results are based on user input values and general assumptions and provide only estimated

Project Block	LNEEE40-125/15/EP05CS4	Created by		Last update	9/29/2021
		Created on	9/29/2021		